

# HYGROPHIL® HCDT

Measuring system for determining the dew point of hydrocarbons in natural gas

Series A



Operating manual

Software version 1.8.x

387897MDHENC V1.2



## Contents

Contents	Page
<b>1</b>	<b>System description</b> <b>1-1</b>
1.1	Measurement principle, Function and applications 1-1
1.2	Declaration of Conformity 1-2
1.3	Layout of the humidity measurement system 1-2
1.3.1	Operator controls and display elements 1-2
1.3.2	Interfaces 1-7
1.4	Technical data 1-11
1.4.1	Evaluation unit F 5673 1-11
1.4.2	CPU plug-in unit type 5673-113 1-13
1.4.3	Power supply plug-in unit DC 10...36V type 5673-108 1-13
1.4.4	Power supply plug-in unit AC 100..240V type 5673-109 1-13
1.4.5	HCDT-sensor plug-in unit type 5673-106 1-14
1.4.6	Analog I/O Ex type 5673-114 1-15
1.4.7	Interface module type 5673-110 1-16
1.4.8	Relay-Interface module type 5673-115 1-18
1.4.9	Polychromator plug-in unit type 5673-302 1-19
1.4.10	Humidity sensor L1661 1-19
1.4.11	HCDT sensor type 1510-11 1-21
1.4.12	Power Supply type 1510-100 1-23
1.4.13	Power Supply type HCDT 1510-101 1-25
1.4.14	Power Supply type HCDT 1510-102 1-26
1.4.15	Power supply with shaft temperature tracking HCDT 1510-104 1-27
1.4.16	Power supply with shaft temperature tracking HCDT 1510-105 1-28
1.5	Spare parts, accessories 1-29
<b>2</b>	<b>Safety precautions</b> <b>2-1</b>
<b>3</b>	<b>Installation</b> <b>3-1</b>
3.1	General 3-1
3.2	Arrangements for EMC 3-1
3.3	Sensor L166x 3-2
3.3.1	Wiring the sensor L166x 3-2
3.3.2	Installing the sensor L166x 3-6
3.3.3	Installation advice 3-7
3.4	HCDT Sample system types 5985-7x/8x/9x 3-9
3.4.1	Drawings 3-10
3.4.2	Wiring 3-19
3.4.3	Connections and initial operation 3-28
<b>4</b>	<b>Operation</b> <b>4-1</b>
4.1	Start up 4-1
4.2	Automatic sensor equalizing 4-1
4.3	Display modes 4-2
4.3.1	Combined display 4-3
4.3.2	Measurement value display with six lines 4-6
4.3.3	Online graphic display 4-6
4.3.4	History graphic display 4-7
4.4	Data export 4-13
4.4.1	Copy data 4-13
4.4.2	Converting data 4-14
4.4.3	Export service information to an external data medium 4-15
<b>5</b>	<b>Programming</b> <b>5-1</b>
5.1	General instructions 5-1
5.2	Calling up programming mode 5-2
5.3	Selecting and opening the menu 5-3
5.4	Editing parameters 5-4

5.4.1	Selecting the parameter setting	5-4
5.4.2	Selecting the parameters for editing	5-5
5.4.3	Numerical entries	5-5
5.5	Structure of the programming menu	5-6
5.6	Program parameters	5-12
5.6.1	Dimension units	5-12
5.6.2	HCDT Configuration	5-13
5.6.3	Analog outputs	5-15
5.6.4	Analog inputs	5-17
5.6.5	Limits	5-18
5.6.6	Selecting the MC Calculation Method	5-20
5.6.7	Edit Gas Data	5-23
5.6.8	Modbus/Profibus	5-30
5.6.9	Date and time	5-31
5.6.10	Serial output	5-32
5.6.11	Offset	5-33
5.6.12	Reset configuration to default	5-34
5.6.13	Language	5-36
5.6.14	System Information	5-37
5.6.15	Change Password	5-37
5.6.16	Maintenance menu	5-38
<b>6</b>	<b>Error handling</b>	<b>6-1</b>
6.1	Limit transgressions	6-1
6.2	Warnings	6-2
6.3	Errors	6-2
6.4	HELP-key	6-3
<b>7</b>	<b>Maintenance</b>	<b>7-1</b>
<b>8</b>	<b>Bus systems</b>	<b>8-1</b>
8.1	Modbus	8-1
8.2	Profibus	8-6
8.3	Modbus TCP/IP	8-10
<b>9</b>	<b>Appendix</b>	<b>9-1</b>
<b>10</b>	<b>Add-on</b>	<b>10-4</b>
10.1	New parameter: Temperature compensation	10-4
10.2	Conversion of measured dew point	10-7
10.3	Shaft temperature tracking	10-10
10.4	New MC calculation methods	10-13
10.4.1	Application specific factor	10-13

*All rights reserved and subject to change.  
Duplication, processing and distribution of this document,  
including parts thereof, is prohibited without the prior  
written consent of BARTEC.*

Copyright © 2021 by BARTEC  
Schulstraße 30,  
D-94239 Gotteszell

Document:	387897MDHENC V1.2	valid from: 10.11
Revision:	Software version 1.8.x	21.12.2021
Author:	G. Rothe	
Translation:	E. Bauernfeind	



# 1 System description

## 1.1 Measurement principle, Function and applications

HYGROPHIL® F 5673 is a high-quality, microprocessor-controlled fibre-optic hygrometer for measuring the moisture or trace humidity at low dew-point temperatures in gases and liquids.

The version HYGROPHIL® HCDT is equipped with a special sensor and is used in one-channel mode for measuring the dew point of hydrocarbons.

### Measurement of water dew point temperature (Gas humidity)

The water dew point is measured with the HYGROPHIL® F and sensor type L166x.

The moisture sensor, type L166x, consists of a robust multi-layer of optically high and low refractive layers connected to 2 fibre-optical cables.

Due to a special thermal coating technique, pores are generated on the layer.

Due to the moisture equilibrium content, water is deposited in the layer and changes the refractive index of the irradiating light (air: 1.00/water 1.33).

Within the layer system this results in a wavelength shift in proportion to the moisture prevailing in the medium.

This shift is measured by the evaluation unit and assigned to a dew point.

The L166x probe makes measurements which are temperature compensated by the integrated Pt100.

In short, the HYGROPHIL® F 5673 works in conjunction with a combination sensor which fibre-optically determines the moisture content and measures the temperature in the medium with a Pt100.

Apart from the extremely robust construction of the sensor, it is above all else, the measurement technique which offers several decisive advantages.

Some of the advantages of this patented measuring method are as follows:

- High measuring confidence, including precision, reproducibility and low hysteresis.
- Long-term stability of the sensor (no drift!)
- Measurement is possible on the high-pressure side (pressure dew point!)
- Application in explosive areas (up to zone 0)
- Simple installation and upgrading (Swagelok, Parker, ...)

The L166x was developed especially for natural gas applications and is now applied in trace moisture measurement for a large number of different gases and liquids.

Due to the usage of high-quality materials, the sensor is extremely robust and resistant to most media.

## 1.2 Declaration of Conformity

We, BARTEC BENKE GmbH, Schulstraße 30, D-94239 Gotteszell, hereby declare that this product complies with the basic requirements of the relevant EU directives.

You can obtain the EU Declaration of Conformity for this product from BARTEC BENKE GmbH, Schulstraße 30, D-94239 Gotteszell, [info@bartec-benke.de](mailto:info@bartec-benke.de).

## 1.3 Layout of the humidity measurement system

The measurement system consists of an evaluation unit and the humidity sensor (including the calibration data plug), the special fibre-optic combined cable and the sample system for measuring the hydrocarbon dew point.

The evaluation unit is designed as a 19" rack which can take several plug-in units. The evaluation unit can also be installed as a desktop device.

The humidity sensor consists of a sensor layer and an integrated temperature sensor, the fibre-optic cable and the plug connector, which also contains the sensor's adjustment data.

The humidity sensor is available in different standard dimensions, however the sample system is designed for the 36 mm version.

### 1.3.1 Operator controls and display elements

All operator controls and display elements are at the front side of the evaluation unit. The device is not equipped with a mains switch. If required, you have to disconnect the device from the mains supply (mains plug). If operated as a desktop device, the two front feet of the evaluation unit can be swivelled out for easier operation and a better viewing angle.

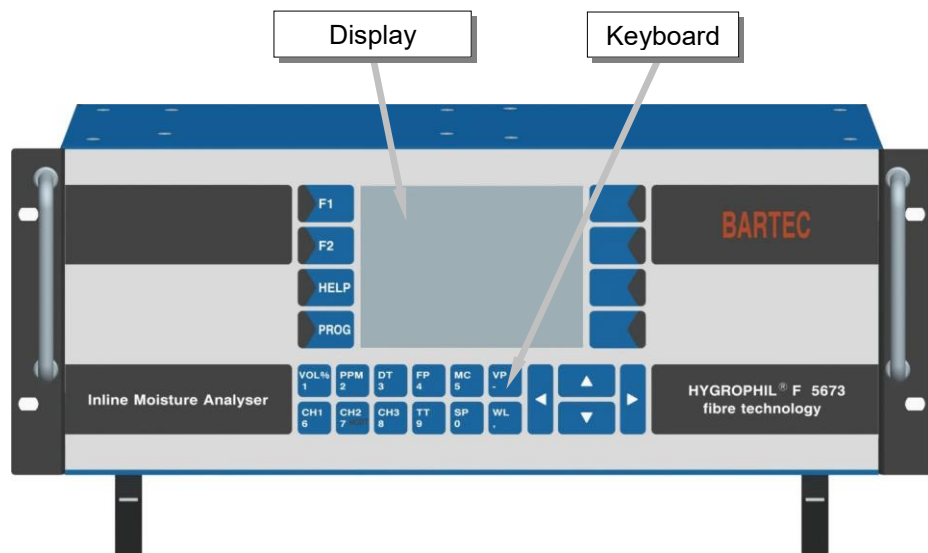

*HYGROPHIL® F 5673, front view*



### **1.3.1.1**

## **Keyboard**

The device is operated via touch-sensitive keys on the front side of the device (numeric and measurement variable keys) and via certain key functions of the touch-screen. All keys are touch-sensitive, i.e. you don't need to press them, only touch them.

### Key functions

(1)	}	VOL% 1	Indication of the water vapour content [Vol%], optional relative humidity [RH] (see section 4.3.1.2)
		PPM 2	Indication of the water vapour content in parts per million volume or in parts per million weight
		DT 3	Indication of the Dewpoint Temperature
		FP 4	Indication of the Frostpoint Temperature
		MC 5	Indication of the Moisture Content [mg/m <sup>3</sup> ] or [lb/MMscF ]
		VP -	Indication of the water Vapour Partial Pressure
		CH1 6	not used
		CH2 7 <small>HCDT</small>	Indication of the Hydrocarbon Dewpoint Temperature
		CH3 8	not used
		TT 9	Indication of the temperature at the measuring point (True Temperature)
		SP 0	Indication of the pressure at the measuring point (Sample Pressure)
		WL ,	Indication of the Wave Length

(1) In the entering mode or programming mode, these keys serve to enter numerical values.

(2)	}	F1	Trigger the sensor equalizing (see section 4.2) Call up the history setup (see section 4.3)
		F2	Switch from online graphic mode to history graphic mode (see section 4.3)

(2) If these two keys are not labelled with F1 and F2 at your measuring device, this does not mean its functional range is restricted. The function of the keys is available anyhow.

Display of warnings and error messages

Call up the programming mode (see section 5.2)

	Selection keys (see section 5.3), Switch between the display modes (see section 4.3)
	Change the cursor position in entry fields (see section 5.4.3)

The four keys to the right of the display are not labelled. Depending on the operating status of the measurement system, different functions are assigned to them. The current function is marked by a symbol next to the key in the display (for the meanings of the symbols see section 5.1).

**Example**

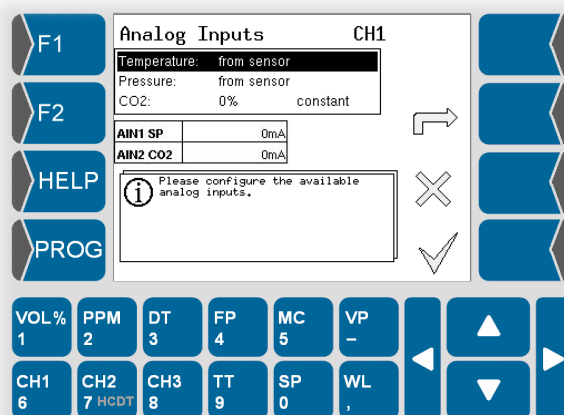

In several operating situations is the current function of the **F1** and **F2** keys as well as the four keys to the right of the display only displayed when touching one of these keys.

**Example**

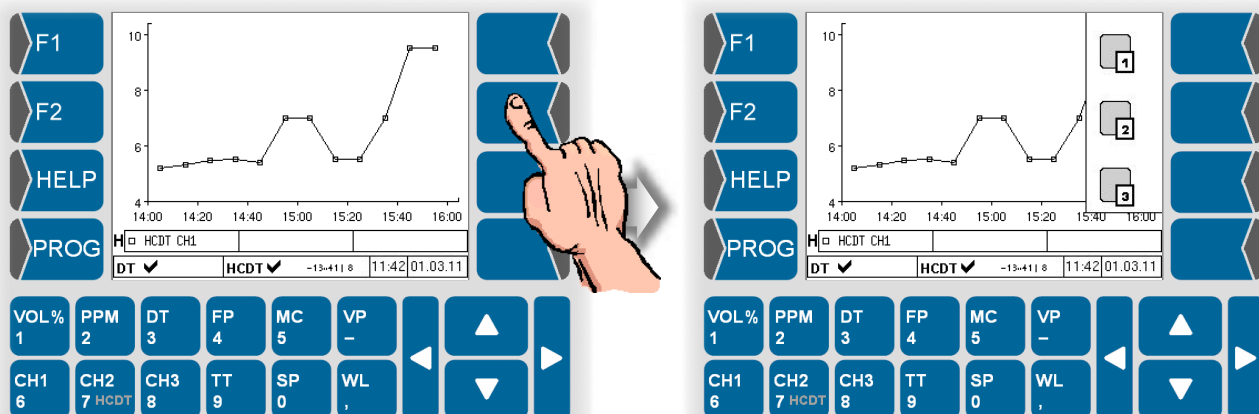

When the function is displayed you can start the function by touching this key.

### 1.3.1.2 Display

A graphic display screen designed as a touch-screen is used for display purposes.

Some functions are operated by means of key functions located on the display screen in dependence on the situation.

*Example*

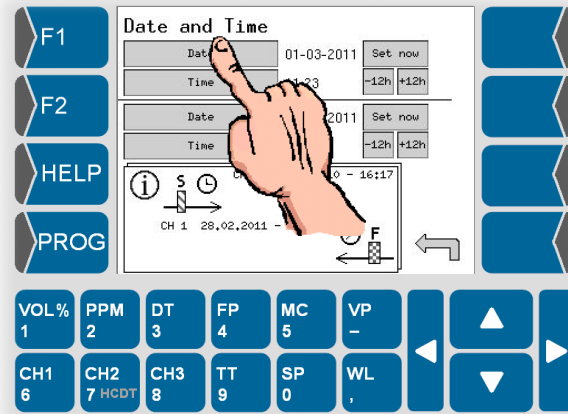

## 1.3.2 Interfaces

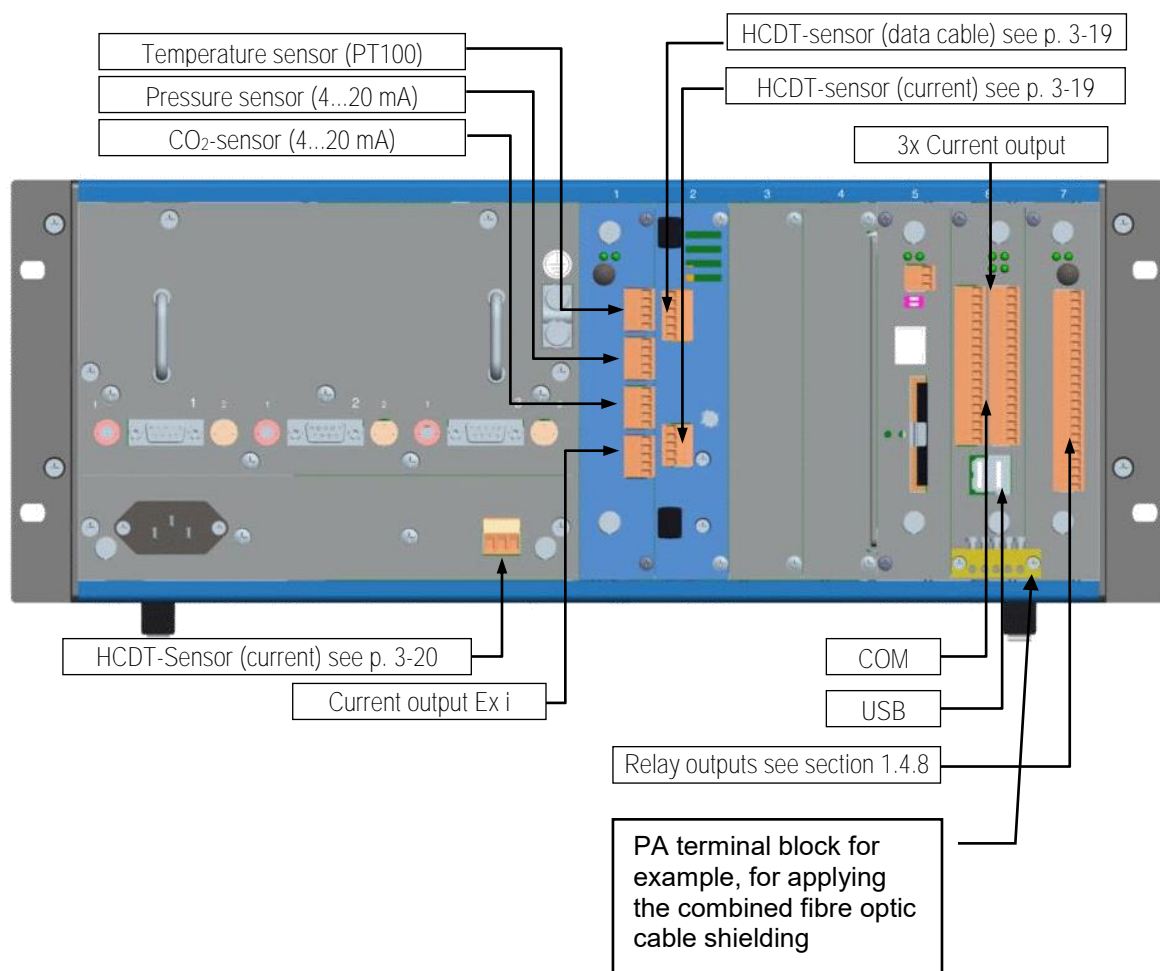
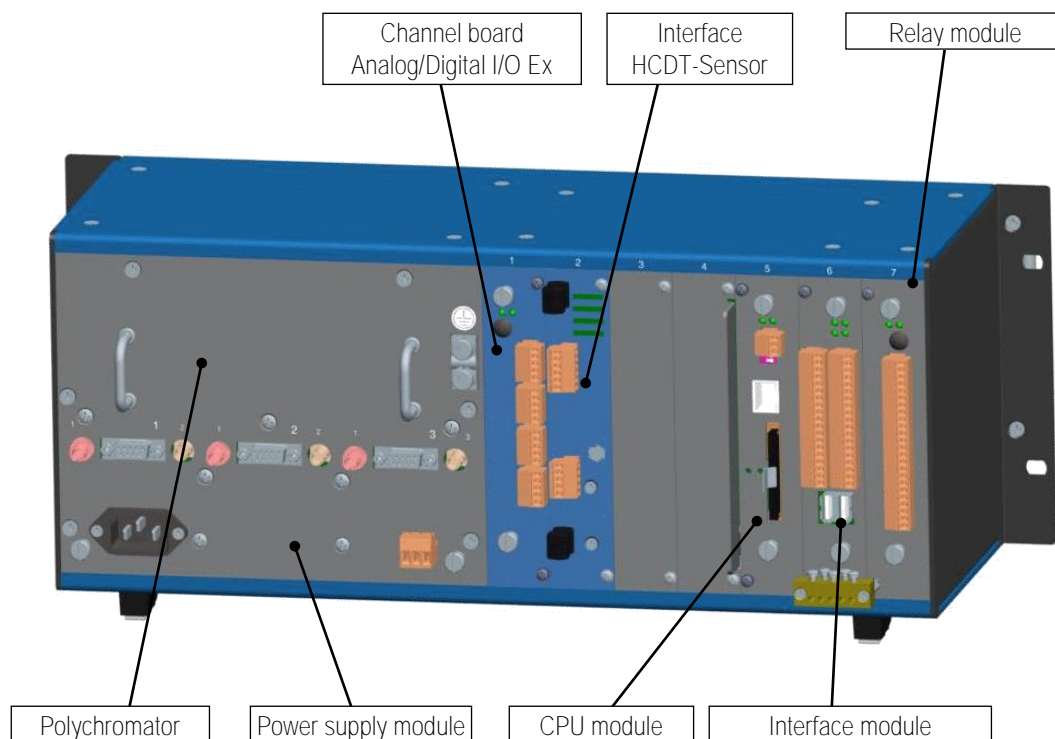

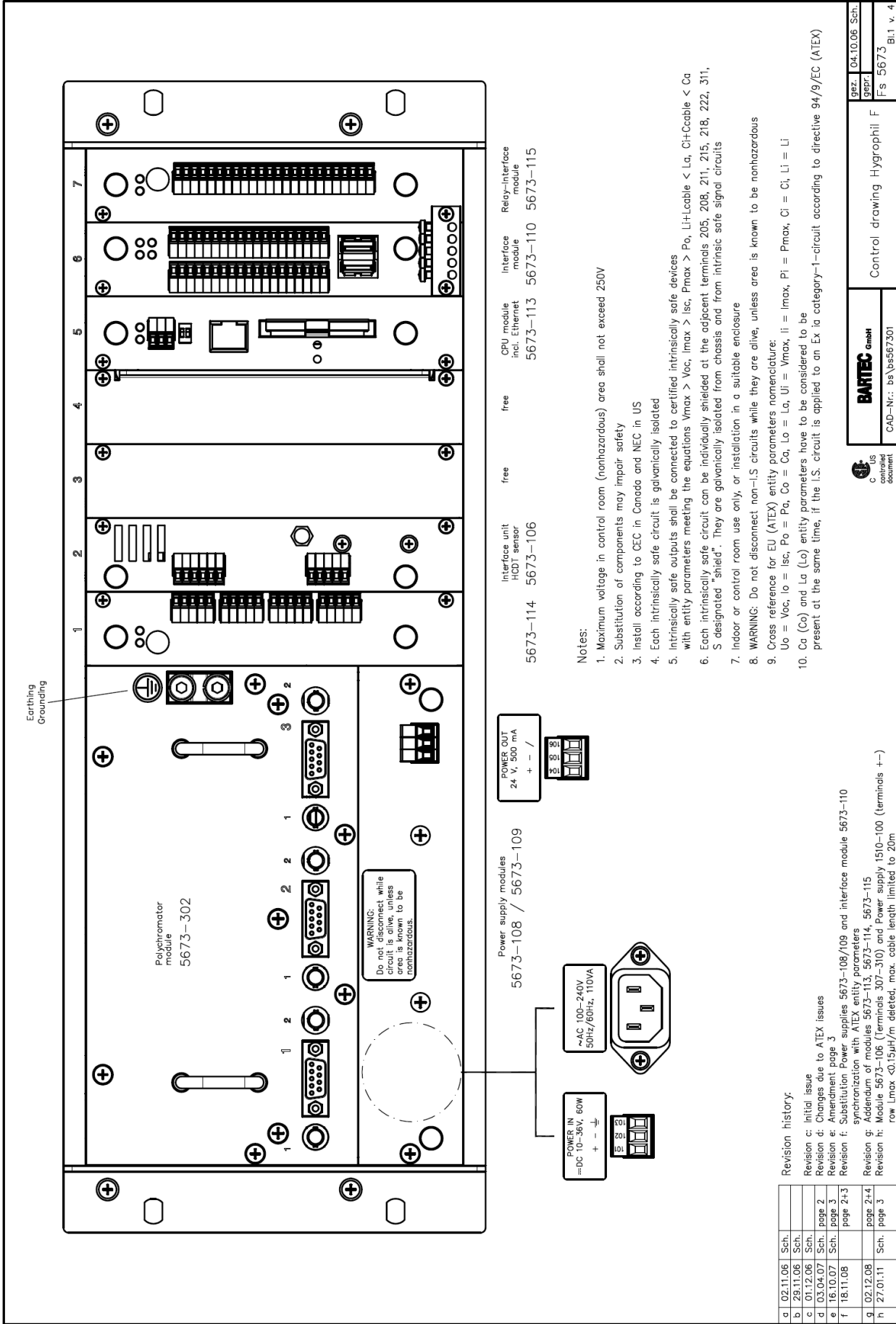

- Notes:
1. Maximum voltage in control room (non-hazardous) area shall not exceed 250V
  2. Substitution of components may impair safety
  3. Install according to CEC in Canada and NEC in US
  4. Each intrinsically safe circuit is galvanically isolated
  5. Intrinsically safe outputs shall be connected to certified intrinsically safe devices with entity parameters meeting the equations  $V_{max} > V_{oc}$ ,  $I_{max} > I_{sc}$ ,  $P_{max} > P_o$ ,  $L_{H-Loable} < L_a$ ,  $C_{H-Cable} < C_a$
  6. Each intrinsically safe circuit can be individually shielded at the adjacent terminals 205, 208, 211, 215, 218, 222, 311, 315 designated "shield". They are galvanically isolated from chassis and from intrinsic safe signal circuits
  7. Indoor or control room use only, or installation in a suitable enclosure
  8. WARNING: Do not disconnect non-I.S circuits while they are alive, unless area is known to be non-hazardous
  9. Cross reference for EU (ATEX) entity parameters nomenclature:  
 $U_o = V_{oc}$ ,  $I_o = I_{sc}$ ,  $P_o = P_o$ ,  $C_o = C_a$ ,  $L_o = L_a$ ,  $U_i = V_{max}$ ,  $I_i = I_{max}$ ,  $P_i = P_{max}$ ,  $C_i = C_i$ ,  $L_i = L_i$
  10. Ca (Co) and La (Lo) entity parameters have to be considered to be present at the same time, if the I.S. circuit is applied to an Ex ia category-1-circuit according to directive 94/9/EC (ATEX)

d	02.11.06	Sch.	
e	29.11.06	Sch.	
f	01.12.06	Sch.	
g	03.04.07	Sch.	page 2
h	16.10.07	Sch.	page 3
i	18.11.08	Sch.	page 2+3
j	02.12.08	Sch.	page 2+4
k	27.01.11	Sch.	page 3

Revision history:

Revision c: Initial issue  
 Revision d: Changes due to ATEX issues  
 Revision e: Amendment page 3  
 Revision f: Synchronization with ATEX entity parameters  
 Revision g: Addendum of modules 5673-113, 5673-114, 5673-115  
 Revision h: Module 5673-106 (terminals 307-310) and Power supply 150-100 (terminals +-)  
 row  $I_{max} < 0.15 \mu\text{A}/\text{m}$  deleted, max. cable length limited to 20m

proj.	04.10.06	Sch.
gepr.		
FS	5673	Bl.1 v. 4

Control drawing Hygrophil F

CAD-Nr.: bs\bs567301

BARTEC GmbH  
 controlled document

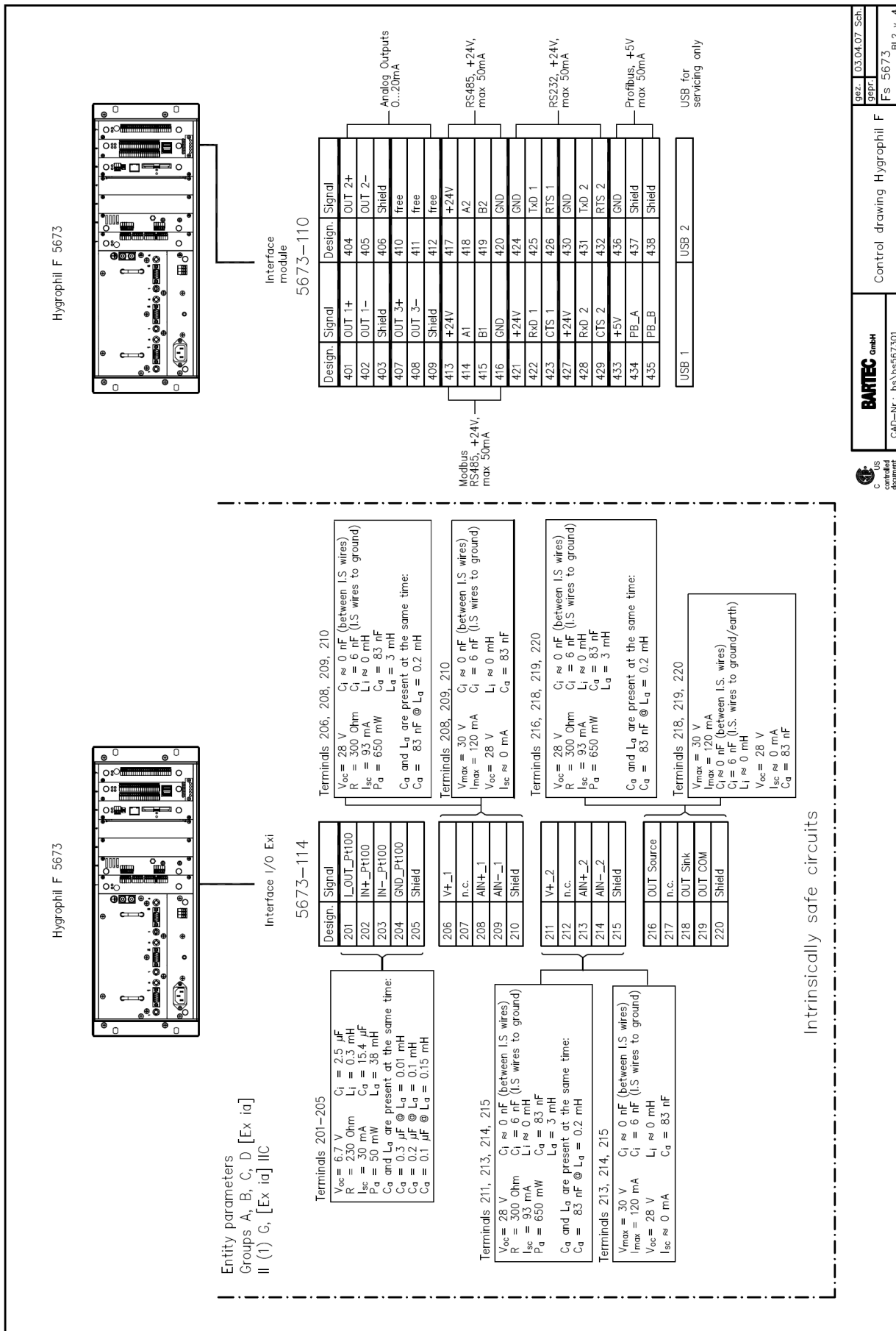





## 1.4 Technical data

### 1.4.1 Evaluation unit F 5673

Evaluation unit			
Specific data			
Display ranges (not the measuring range)	<i>Measurement variable</i>	<i>Lower range limit</i>	<i>Upper range limit</i>
	Vol% [%]	0	100
	PPMV [ppm]	1	25000
	VP [hPa]	0	250
	MC [mg/m <sup>3</sup> , [lb/MMscF]	0.5	30000
	DT/FP [°C, °K, °F]	-100	+100
	HCDT [°C]	-30	+30
	SP [bar, PSI, ...]	0	250
	TT [°C, °K, °F]	-50	+100
Display	Graphic display with 320 x 240 dots		
Keyboard	Red backlit touch-screen		
Electrical data			
Auxiliary energy	DC 10 - 36 V max. 60 W (Si 6.3 A T) AC 100 - 240 V max. 110 VA (Si 3.15 A MT)		
Auxiliary variables	The temperature (TT) at the measuring point is measured via a sensor integrated in the humidity sensor or entered by hand. The pressure (SP) is measured via a 4...20 mA signal from an external pressure transmitter or entered by hand. CO <sub>2</sub> -content (0...100%) is measured via a 4...20 mA-signal or entered by hand.		
Measurement channels	1 x DT, 1 x HCDT		
Measuring rate	Max. 3 measurements per minute (DT) 6 measurements per hour at 5 °C HCDT (first measuring value after 30 min)		
Inputs	<ul style="list-style-type: none"> <li>- Light waveguide port for optical humidity sensor</li> <li>- 9-pole D-SUB plug for for characteristic curve of sensor</li> <li>- Clamp-type terminal for PT 100 measurement sensor in sensor head</li> <li>- Clamp-type terminal for signal from a pressure transmitter for absolute pressure (4...20 mA)</li> <li>- Clamp-type terminal for HCDT Sensor</li> <li>- Clamp-type terminal for CO<sub>2</sub> content (4...20 mA)</li> </ul> all inputs Ex ia, galvanically isolated		
Analog outputs (at Analog-IO Ex Typ 5673-114)	Clamp-type terminal 0/4...20 mA, EEx ia, galvanically isolated Source or sink intrinsically safe Resolution 0.0003 mA Max. load: 500 Ω Accuracy: 0.03 mA Temperature drift: <0.001 mA/ °C		
3 analog outputs at the COM-plug in unit	Clamp-type terminal 0/4...20 mA, galvanically isolated Source not intrinsically safe Resolution 0.0003 mA Load <800 Ω Accuracy ± 0.15 % (0.03 mA) Temperature drift < 0.001 mA/°C		
Control outputs	8 relay changeover contact, 30 V / 1 A Connection via plug-in terminals 2 switching outputs "Limit" and "Error"		
Interfaces	Ethernet, RS 232, RS 485 Modbus, Profibus, USB		

Ambient conditions	
Operating temperature	0 ... +50 °C
Storage temperature	-20 ... +60 °C
Climatic class	IWI nach DIN 40040
Approvals	ATEX, CSA, GOST
Mechanical data	
Weight	Ca. 8.5 kg
Dimensions	WxHxD 483 x 192 x 212 mm
	can be used as 19" build in and as desktop version
Dimensions of evaluation unit: 19" build in version / desktop version, dimensions in mm	
Type: 5673-10, 5673-12	Order No.: 284492, 246119

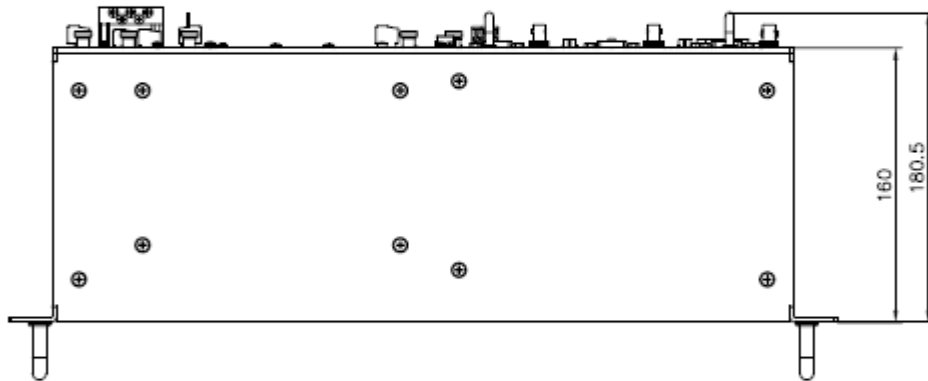
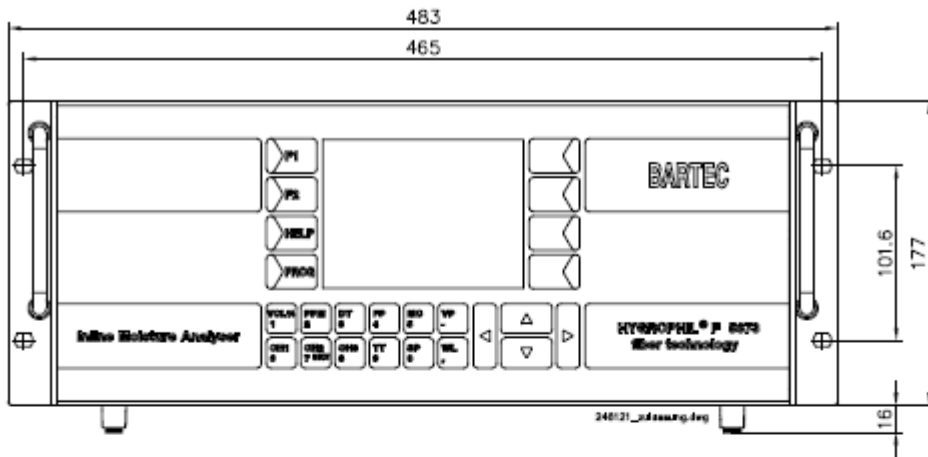

Rear view

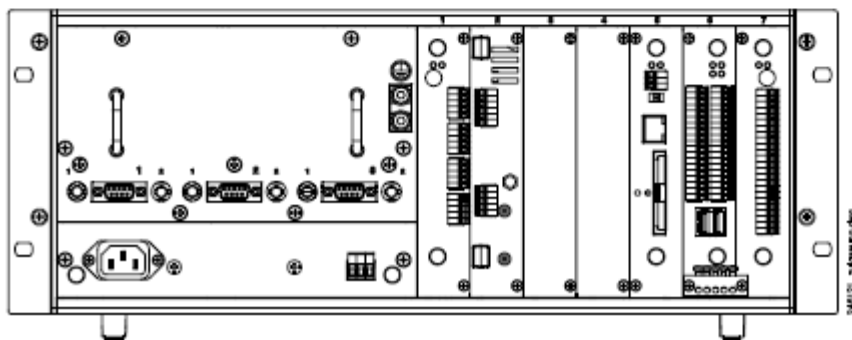

## 1.4.2 CPU plug-in unit type 5673-113

Electrical data	
Operating voltage CPU	5.5 V $\pm$ 2 %
Power consumption	800 mA
Fuse of battery	3.5 A
Interfaces	
USB 2.0 Host	OHCI
Ethernet	100 MBit
Serial interfaces	5x up to 115200 Bit/s, 3.3 V LVTTTL 2x up to 460800 Bit/s, 3.3 V LVTTTL
Ambient conditions	
Operating temperature	-10... +50 °C
Storage temperature	-20... +70 °C
Climatic class	JWF in accordance with DIN 40040
Protection type	IP00 in accordance with DIN 40050

## 1.4.3 Power supply plug-in unit DC 10...36V type 5673-108

Electrical data	
Input voltage	DC 10...36 V, fuse 6.3 A (T)
Output voltage	5.5 V 3.2 A short-circuit-proof 24 V 1.2 A short-circuit-proof 10 V max. 100 mA
Maximum output power	60 W
Ambient conditions	
Operating temperature	-10 ... + 50 °C
Storage temperature	- 20 ... + 70 °C

## 1.4.4 Power supply plug-in unit AC 100..240V type 5673-109

Electrical data	
Input voltage	AC 100...240 V, fuse 3.15 A (MT)
Output voltage	5.5 V 3.2 A short-circuit-proof 24 V 1.2 A short-circuit-proof 10 V max. 100 mA
Maximum output power	110 VA
Ambient conditions	
Operating temperature	-10...+ 50 °C
Storage temperature	-20...+ 70 °C

## 1.4.5 HCDT-sensor plug-in unit type 5673-106

<b>Use</b>	
connecting a HCDT sensor to the evaluation unit 5673	
<b>Electrical data</b>	
Auxiliary energy	5.5V max. 0.1A / 24V max. 0.5A
<b>Connections</b>	
Power supply for HCDT sensor 1510-106	9-11V intrinsically safe
Power supply for data interface	8V intrinsically safe
Data interface	RS 485 full duplex
Design	pluggable terminal blocks
<b>Ambient conditions</b>	
Operating temperature	-10 ... +50°C
Storage temperature	-20 ... +70°C

**EMC:**

To both cables must be fixed ferrite noise filters (order no. 275368) (see section 3.2).

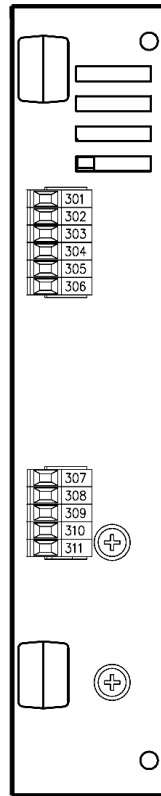

Design.	Signal
301	+ U
302	- GND
303	T_A
304	T_B
305	R_A
306	R_B
307	9-11V +
308	9-11V +
309	9-11V -
310	9-11V -
311	Shield

242082.dwg

**Note: Make sure that the shielding is also applied.**

## 1.4.6 Analog I/O Ex type 5673-114

Electrical data	
Operating voltage for CPU	DC 5.5 V $\pm$ 2 % 200 mA, fuse 400 mA
Operating voltage for sensor supply	DC 24 V $\pm$ 5 %, max. 480 mA, fuse 1 A
PT-100 [Ex ia]	
Type	Pt-100 (4 wires), I 1 mA -50...+100 °C
Resolution	0.005 °C (16 bit)
Separation	galvanically isolated
Analog Output [Ex ia]	
Current range	0/4-20 mA
resolution	0.0003 mA
Separation	galvanically isolated
Sampling	Max. 10 /s
Aktive	Load max. 500 $\Omega$
Passive	$U_{\max}$ :36 V, $U_{\min}$ at 20 mA: 8 V
Analog Input [Ex ia]	
Quantity	2
Input current	4...20 mA
Resolution	0.005 mA
Separation	galvanically isolated
Sampling	Max. 10 /s
output voltage V+1 and V+2	DC 24 V $\pm$ 10% max. 30 mA, short-circuit-proof
Ambient conditions	
Operating temperature	- 10 ... + 50 °C
Storage temperature	- 20 ... + 70 °C

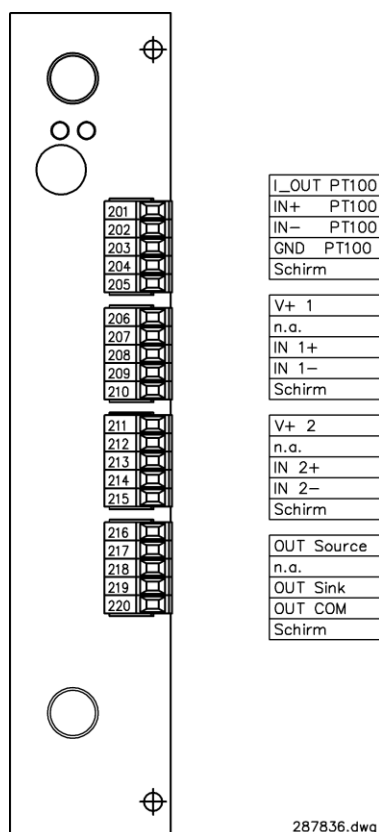
**EMC:**

To the cables of the analog inputs IN1, IN2 and to the cable of the analog output OUT Source must be fixed ferrite noise filters (order no. 275368) (see section 3.2).

## 1.4.7 Interface module type 5673-110

<b>Electrical data</b>	
Operating voltage for CPU	DC 5.5 V $\pm$ 2 %
Operating voltage for interfaces	DC 24 V $\pm$ 5 %
<b>3 x Analog output</b>	
Current range	0/4 – 20 mA, galvanically isolated, source
Resolution	0.0003 mA
Apparent ohmic resistance	< 800 $\Omega$
Accuracy	$\pm$ 0.15 %
Temperature drift	<0.001 mA/°C
<b>2 x RS485</b>	
Functionality	Modbus
Output voltage for each interface	24 V $\pm$ 5 %, max. 50 mA
<b>2 x RS232</b>	
Functionality	Logging
Output voltage for each interface	24 V $\pm$ 5 %, max. 50 mA
<b>Profibus</b>	
Functionality	Profibus DB (Slave)
Output voltage for each interface	5V $\pm$ 2 %, max. 50 mA
<b>2 x USB</b>	
Functionality	Standard USB interface
	Only for service and maintenance purposes
<b>Ambient conditions</b>	
Operating temperature	- 10 ... + 50 °C
Storage temperature	- 20 ... + 70 °C

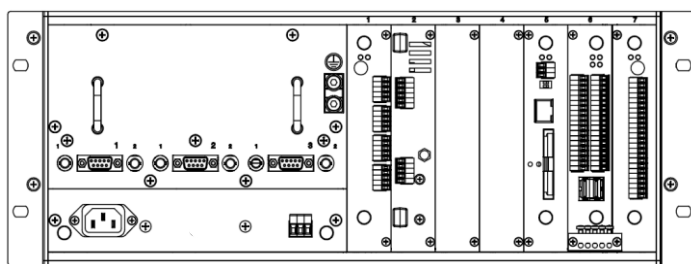

Interface module  
5673-110

	Design.	Signal	Design.	Signal	
Analog Out 1 0/4-20mA	401	OUT 1+	404	OUT 2+	Analog Out 2 0/4-20mA
	402	OUT 1-	405	OUT 2-	
	403	Shield	406	Shield	
Analog Out 3 0/4-20mA	407	OUT 3+	410	free	
	408	OUT 3-	411	free	
	409	Shield	412	free	
* MODBUS RTU RS485, +24V, max 50mA	413	+24V	417	+24V	RS485, +24V, max 50mA
	414	A1	418	A2	
	415	B1	419	B2	
	416	GND	420	GND	
	421	+24V	424	GND	Serial Out (s. 5.6.10) RS232, +24V, max 50mA
	422	RxD 1	425	TxD 1	
	423	CTS 1	426	RTS 1	
	427	+24V	430	GND	MODBUS RTU * RS232, +24V, max 50mA
	428	RxD 2	431	TxD 2	
	429	CTS 2	432	RTS 2	
	433	+5V	436	GND	Profibus, +5V max 50mA
	434	PB_A	437	Shield	
	435	PB_B	438	Shield	

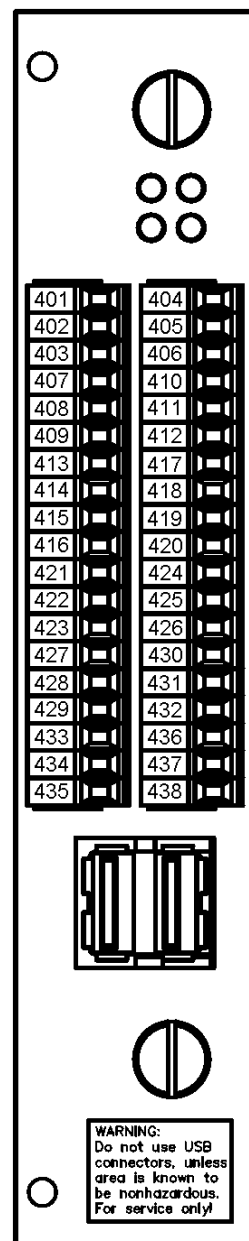

281686.dwg

\* Select the interface for MODBUS in the „Modbus/Profibus“ menu (see section 5.6.8).



Do not use USB connectors, unless area is known to be nonhazardous.  
For service only!

**EMC:**

To all cables of the analog outputs OUT1, OUT2, OUT3 must be fixed ferrite noise filters (order no. 275368) (see section 3.2).

# 1.4.8 Relay-Interface module type 5673-115

Electrical Data	
Operating voltage CPU	DC 5.5 V ± 2 % 70 mA, fuse 500 mA
Operating voltage 24 V	DC 24 V ± 5 % 60 mA, fuse F3A
Relays	
Type	Change-over contact
Insulation	1500 Vrms
Contacts	30V, 1A
Ambient conditions	
Operating temperature	- 10 ... + 50 °C
Storage temperature	- 20 ... + 70 °C

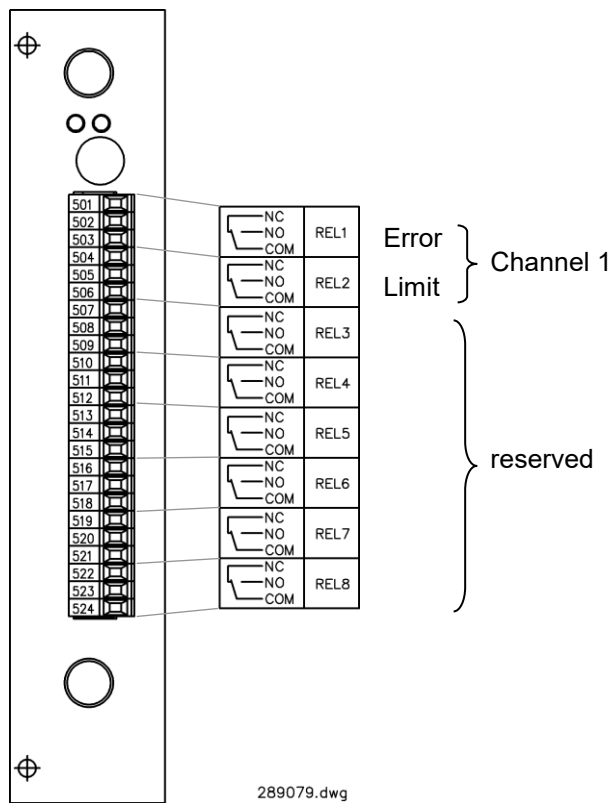

**Switching operations:**

From software version 1.7.7 the switching operations have changed as follows: The relays are activated in normal operation and deactivated when causing an ERROR- or LIMIT-signal.

Analyzer off

Analyzer on  
no ERROR  
no LIMIT

Analyzer on  
ERROR  
LIMIT

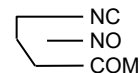
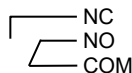
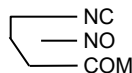



## 1.4.9 Polychromator plug-in unit type 5673-302

Electrical data	
Operating voltage	DC 5.5 V
Power consumption	200 mA
Connection type	ST plug optical (sensor)
Interface	USB 12 Mbit/s (full speed)
Measuring range	ca. 720...870 nm
Resolution	2000 Pixel $\cong$ 0.17 nm/Pixel
Ambient conditions	
Operating temperature	- 10...+ 50 °C
Storage temperature	- 20...+ 60 °C

## 1.4.10 Humidity sensor L1661

The sensor is designed with a pore structure suitable for trace humidity applications. A single sensor element covers the dew-point range from +20 °C DT to -80 °C DT. Moisture condensation does not impair the sensor; once dry it can be used again without having to be recalibrated, i.e. it can be used without difficulty in most processes subject to temporary condensation.

Permissible working temperature	-30...+60 °C
Permissible storage temperature	-30...+ 60 °C
Integrated Pt100	DIN IEC 751, 4-wire class A
Calibrated Range	-80 ... +20°C DT
Accuracy	+/- 1K
Max. permissible working pressure	100 bar, 200 bar with certificate (gas-pressure test)
Material	Shaft: 1.4571 Sensor head: POM
Protection type	IP 65 (in built-in state)
Approvals	ATEX, CSA, CRN, GOST

Dimensions in mm

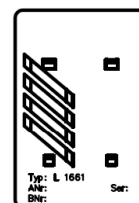
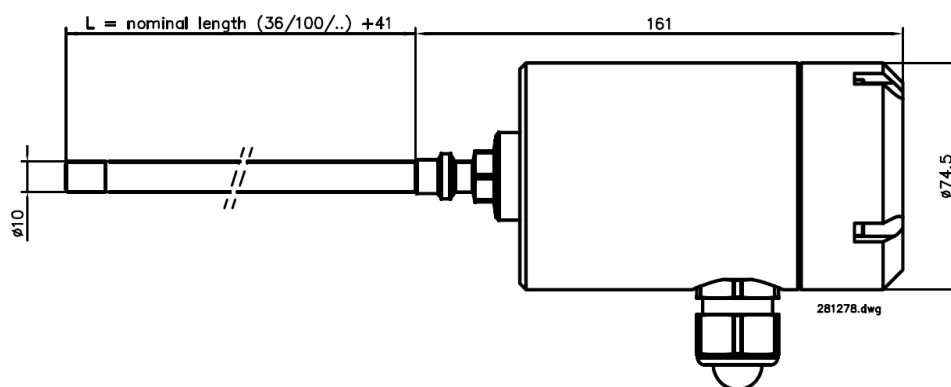

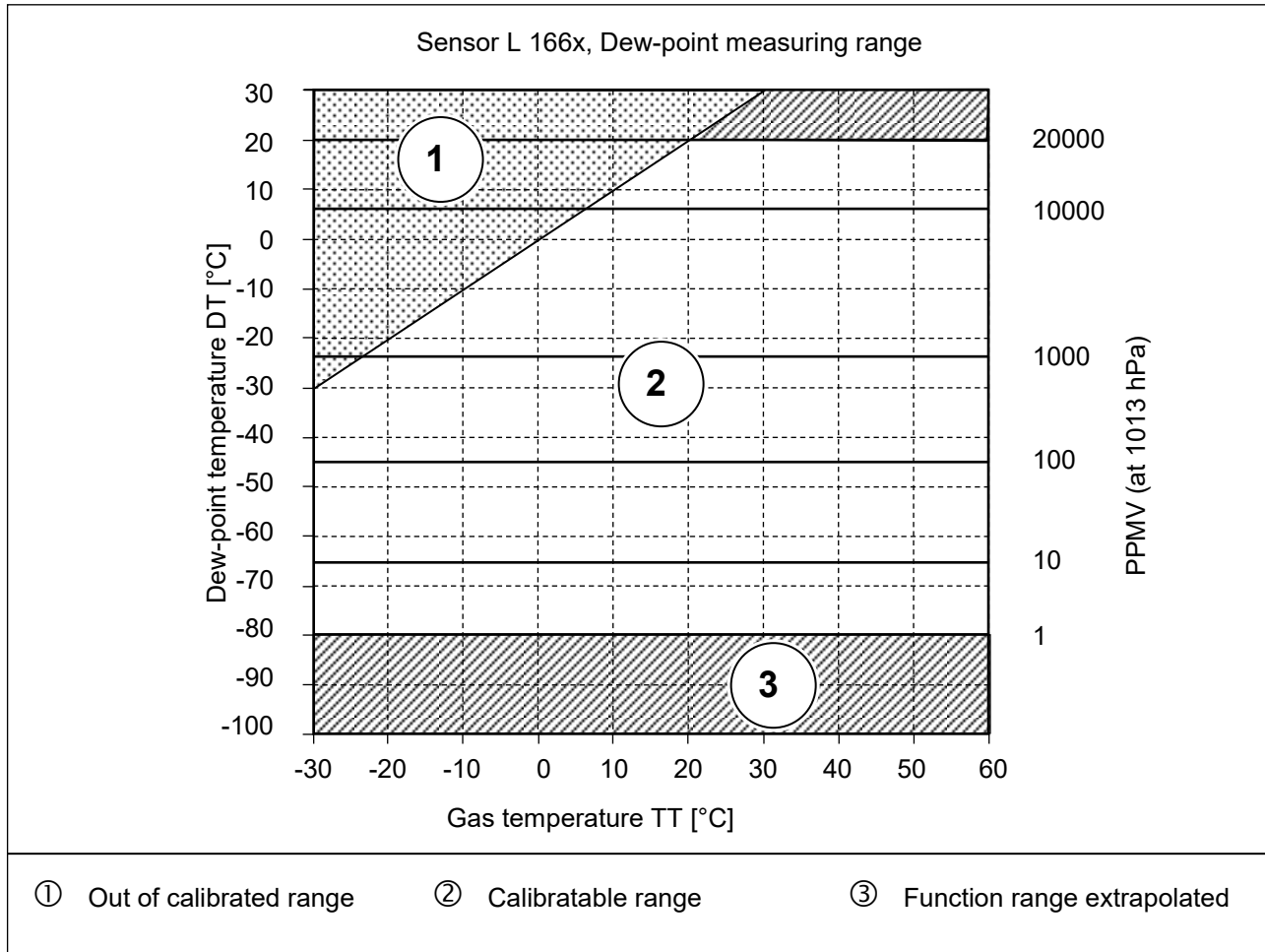

## 1.4.11 HCDT sensor type 1510-11

The optical hydrocarbon dew-point sensor HYGROPHIL HCDT is designed for the measurement of the hydrocarbon dew-point in gases.

Device-specific data	
Application range of HCDT	-30 ... +30°C
Calibrated range (standard)	-20 ... +5°C
Maximal cooling compared to pre-cooling	Up to 35 K
Accuracy HCDT	+/- 1K
Application- measurement range	
<p>By default setting pre-selected sensor shaft temperature determines the dewpoint measurement range.</p>	
Measuring rate	Approx 6 measurements per hour at 5 °C HCDT Approx 2 measurements per hour at -10 °C HCDT
Electrical data	
I.S. Power supply (for connection to plug-in unit type 5673-106 or power supply type 1510-100)	Terminal SL2: 1, 2, ... (+), 3, 4, ... (-) Input voltage $V_{nom}$ DC 9...11 V Input current $I_{nom}$ 11 V 315 mA 10 V 360 mA 9 V 415 mA
Data (separated intrinsically safe circuit, passive) (for connection to plug-in unit type 5673-106)	Terminal SL4: 1 (+U, 2 (GND), 3 (T_A), 4 (T_B), 5 (R_A), 6 (R_B) RS 485, 9600 baud, 8 bit, no parity, 1 stop bit
Digital output, shaft temperature tracking	Terminal SL5: 5 (+OUT), 6 (-OUT)
Intrinsically safe electrical circuit for connecting the power supply to the Peltier cooling Type 1510-104 or 105	

### 1.4.11.1 Transmitter type 1510-11

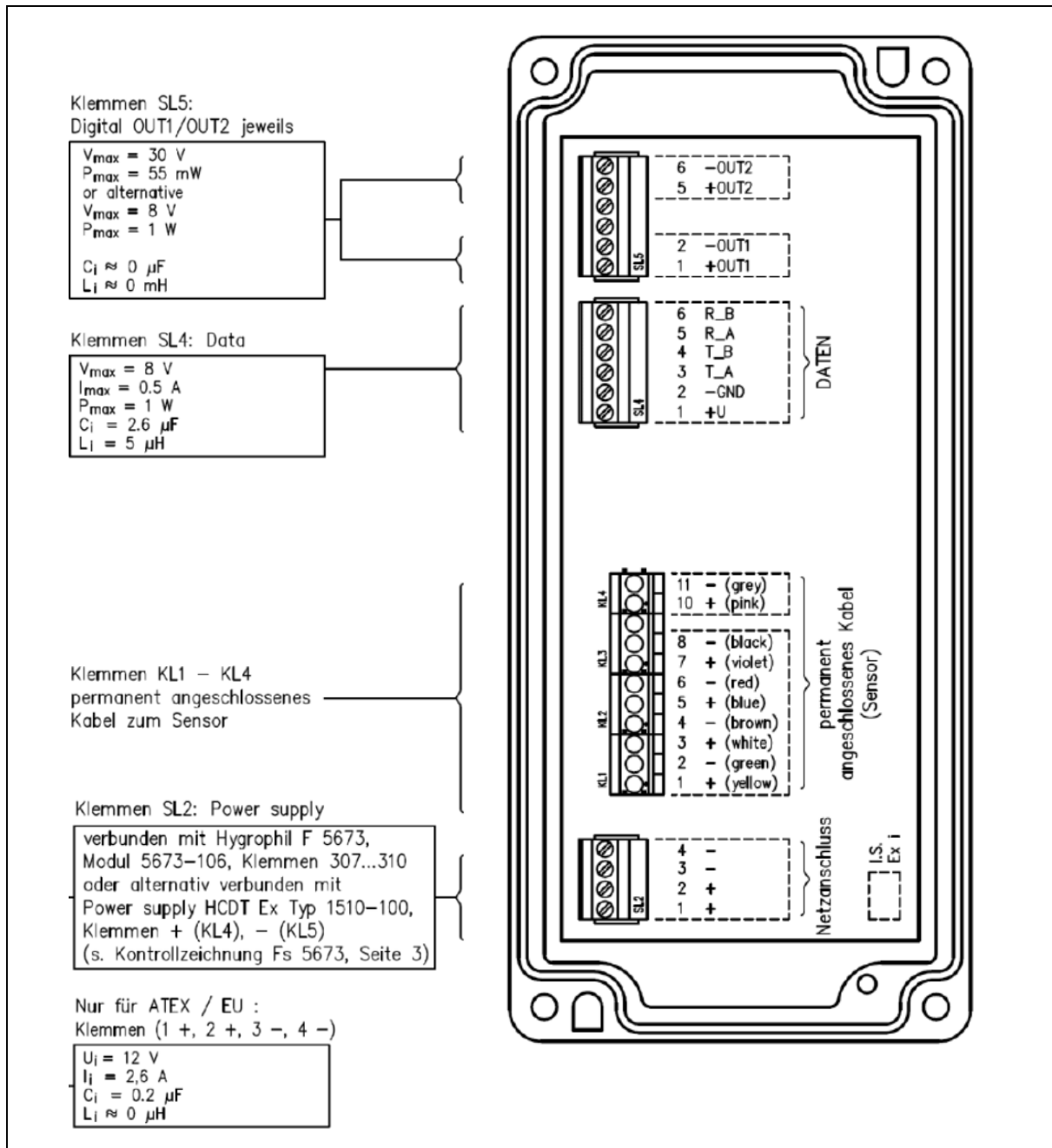

## 1.4.12 Power Supply type 1510-100

The power supply provides an intrinsically safe circuit. It is especially designed for the optical dewpoint sensor HYGROPHIL HCDT 1510-11, if the distance between the sensor and the evaluation unit is larger than 20 meters.

The intrinsically safe circuit is galvanically separated from input circuit.

The power supply can be installed in classified hazardous locations Zone 1 or Class I, Division 1.

<b>Electrical data</b>																						
Power supply circuit	Terminals (0V, 24 V) Input voltage DC 24 V $\pm$ 10% Input current 0.3 A @ DC 24 V Input power 7.2 W max. voltage under fault conditions $U_m$ AC 250 V																					
Intrinsically safe power supply circuit	Terminals, light blue (S, + -) Type of protection Intrinsic Safety Ex ia IIC/IIB/IIA Nominal values: DC 10 V, 0.36 A Maximum values (mandatory for ATEX only): $U_o = 11.6$ V $I_o = 2.1$ A $P_o = 7.2$ W $R_s = 6.5$ $\Omega$ trapezoidal characteristic $C_i = 0.6$ $\mu$ F $L_i \approx 0$ mH if capacitance and inductance are present at the same time: <table style="width: 100%; border: none;"> <tr> <td style="width: 33%;">Group IIC</td> <td style="width: 33%;">Group IIB</td> <td style="width: 33%;">Group IIA</td> </tr> <tr> <td><math>C_o = 1.0</math> <math>\mu</math>F at</td> <td><math>C_o = 5.7</math> <math>\mu</math>F at</td> <td><math>C_o = 6.6</math> <math>\mu</math>F at</td> </tr> <tr> <td><math>L_o = 10</math> <math>\mu</math>H</td> <td><math>L_o = 55</math> <math>\mu</math>H</td> <td><math>L_o = 80</math> <math>\mu</math>H</td> </tr> </table> maximum external inductance to resistance ratio <table style="width: 100%; border: none;"> <tr> <td style="width: 33%;"><math>L_o / R_o = 4.4</math> <math>\mu</math>s</td> <td style="width: 33%;"><math>L_o / R_o = 20</math> <math>\mu</math>s</td> <td style="width: 33%;"><math>L_o / R_o = 30</math> <math>\mu</math>s</td> </tr> </table> (i.e. $\mu$ s = $\mu$ H/ $\Omega$ ) Maximum Values (for Canada and US) Class I, Division 1, Gp A, B, C, D [Ex ia] see control drawing Fs 5673, page 3, option 2. I.S. output is associated to optical dewpoint sensor HYGROPHIL DT / DTP / HCDT 1510 series only. max. capacitance C and inductance to resistance ratio L / R of wiring acc. F6.9 and F6.10 of Canadian Electrical Code <table style="width: 100%; border: none;"> <tr> <td style="width: 33%;">Groups A, B</td> <td style="width: 33%;">Group C</td> <td style="width: 33%;">Group D</td> </tr> <tr> <td>C = 0.2 <math>\mu</math>F</td> <td>C = 1.8 <math>\mu</math>F</td> <td>C = 5.8 <math>\mu</math>F</td> </tr> <tr> <td>L / R = 25 <math>\mu</math>s</td> <td>L / R = 60 <math>\mu</math>s</td> <td>L / R = 200 <math>\mu</math>s</td> </tr> </table> (i.e. $\mu$ s = $\mu$ H/ $\Omega$ )	Group IIC	Group IIB	Group IIA	$C_o = 1.0$ $\mu$ F at	$C_o = 5.7$ $\mu$ F at	$C_o = 6.6$ $\mu$ F at	$L_o = 10$ $\mu$ H	$L_o = 55$ $\mu$ H	$L_o = 80$ $\mu$ H	$L_o / R_o = 4.4$ $\mu$ s	$L_o / R_o = 20$ $\mu$ s	$L_o / R_o = 30$ $\mu$ s	Groups A, B	Group C	Group D	C = 0.2 $\mu$ F	C = 1.8 $\mu$ F	C = 5.8 $\mu$ F	L / R = 25 $\mu$ s	L / R = 60 $\mu$ s	L / R = 200 $\mu$ s
Group IIC	Group IIB	Group IIA																				
$C_o = 1.0$ $\mu$ F at	$C_o = 5.7$ $\mu$ F at	$C_o = 6.6$ $\mu$ F at																				
$L_o = 10$ $\mu$ H	$L_o = 55$ $\mu$ H	$L_o = 80$ $\mu$ H																				
$L_o / R_o = 4.4$ $\mu$ s	$L_o / R_o = 20$ $\mu$ s	$L_o / R_o = 30$ $\mu$ s																				
Groups A, B	Group C	Group D																				
C = 0.2 $\mu$ F	C = 1.8 $\mu$ F	C = 5.8 $\mu$ F																				
L / R = 25 $\mu$ s	L / R = 60 $\mu$ s	L / R = 200 $\mu$ s																				
<b>Ambient conditions</b>																						
Ambient temperature	-20...+60°C																					

<b>Mechanical data</b>	
<p>Dimensions in mm</p>	
Material of casing	Aluminum cast, coated
Protection type of casing	IP66, EN 60529, (NEMA 4x)

## 1.4.13 Power Supply type HCDT 1510-101

The power supply is used for supply and controlling the Peltier cooling type 5985-103.

The power supply can be installed in classified hazardous locations Zone 1 or Class I, Division 1.

Electrical data			
Input	Power supply terminal (L, N, PE)		
Output	Power supply terminal +, - Output voltage 12 V DC Output current 5 A		
Input	KL2: 5 (E2+)	KL2: 6 (E2-)	Data 5 V DC, 7 mA
Output	KL3: 1 (UV+)	KL3: 2 (UV-)	power supply
	KL4: 3 (PL-)	KL4: 4 (PL+)	Peltier connection
			12 V DC 4 A pulse-width modulated
Pt100 sensor	KL1: 7 (PT+)	KL1: 8 (PT-)	1 mA
Ambient conditions			
Ambient temperature e	-20...+60°C		
Mechanical data			
Dimensions in mm			
Material of casing	Aluminum cast, coated		
Protection type of casing	IP66, EN 60529, (NEMA 4x)		

# 1.4.14 Power Supply type HCDT 1510-102

The power supply is used for supply and controlling the Peltier cooling type 5985-103.

Electrical data			
Input	Power supply terminal +, -		
Output	Power supply terminal +, - Output voltage 12 V DC Output current 5 A		
Input	KL2: 5 (E2+)	KL2: 6 (E2-)	Data 5 V DC, 7 mA power supply Peltier connection 12 V DC 4 A pulse-width modulated
Output	KL3: 1 (UV+)	KL3: 2 (UV-)	
	KL4: 3 (PL-)	KL4: 4 (PL+)	
Pt100 sensor	KL1: 7 (PT+)	KL1: 8 (PT-)	1 mA
Ambient conditions			
Ambient temperature e	-20...+60°C		
Mechanical data			
Dimensions in mm			
Material of casing	Aluminum cast, coated		
Protection type of casing	IP66, EN 60529, (NEMA 4x)		



## 1.4.15 Power supply with shaft temperature tracking HCDT 1510-104

The power supply is used to supply and regulate the Peltier cooling type 5985-103

The power supply can be installed in zone 1 or class I, division 1 potential explosion-risk areas.

Electrical data	
Input	Power supply terminal (L, N, PE)
Output	Power supply terminal +, - Output voltage 12 V DC Output current 5 A
Input	T2: 5 (E2+)      T2: 6 (E2-)      data 5 V DC, 7 mA
Output	T3: 1 (UV+)      T3: 2 (UV-)      voltage supply T4: 3 (PL-)      T4: 4 (PL+)      Peltier connection 12 V DC 4 A pulse width modulated
PT 100 sensor	T1: 7 (PT+)      T1: 8 (PT-)      1 mA
Input, shaft temperature tracking	Terminal SL1: 9 (+) - 10 (-)
Intrinsically safe input, shaft temperature tracking	Terminal SL1: 9 - 10 $U_0 = 8.0 \text{ V}$ $U_0 = 8.0 \text{ V}$ $I_0 = 1.2 \text{ A}$ $P_0 = 1.0 \text{ W}$ $R = 6.8 \Omega$ Linear characteristic curve, $C_i$ and $L_i$ negligibly small $C_0 = 8.4 \mu\text{F}$ $L_0 = 25.0 \mu\text{H}$ For simultaneously occurring reactances $C_0 = 3.4 \mu\text{F}$ $L_0 = 25.0 \mu\text{H}$
Ambient conditions	
Ambient temperature	-20...+60°C
Mechanical data	
Dimensions in mm	
Housing material	Cast aluminum, coated
Housing protection type	IP66, EN 60529, (NEMA 4x)

# 1.4.16 Power supply with shaft temperature tracking HCDT 1510-105

The power supply is used to supply and regulate the Peltier cooling type 5985-103.

Electrical data	
Input	Power supply terminal +, -
Output	Power supply terminal +, - Output voltage 12 V DC Output current 5 A
Input	T2: 5 (E2+)      T2: 6 (E2-)      data 5 V DC, 7 mA
Output	T3: 1 (UV+)      T3: 2 (UV-)      voltage supply T4: 3 (PL-)      T4: 4 (PL+)      Peltier connection 12 V DC 4 A pulse width modulated
PT 100 sensor	T1: 7 (PT+)      T1: 8 (PT-)      1 mA
Input, shaft temperature tracking	Terminal SL1: 9 (+) - 10 (-)
Intrinsically safe input, shaft temperature tracking	Terminal SL1: 9 - 10 $U_0 = 8.0 \text{ V}$ $U_0 = 8.0 \text{ V}$ $I_0 = 1.2 \text{ A}$ $P_0 = 1.0 \text{ W}$ $R = 6.8 \text{ } \Omega$ Linear characteristic curve, $C_i$ and $L_i$ negligibly small $C_0 = 8.4 \text{ } \mu\text{F}$ $L_0 = 25.0 \text{ } \mu\text{H}$ For simultaneously occurring reactances $C_0 = 3.4 \text{ } \mu\text{F}$ $L_0 = 25.0 \text{ } \mu\text{H}$
Ambient conditions	
Ambient temperature	-20...+60°C
Mechanical data	
Dimensions in mm	
Housing material	Cast aluminum, coated
Housing protection type	IP66, EN 60529, (NEMA 4x)

## 1.5 Spare parts, accessories

<i>Designation</i>	<i>Type</i>	<i>Specification</i>	<i>Order No.</i>
<b>Evaluation unit</b>			
	5673-10	AC 100...240 V Class1/Div.2 1 channel pre-installed	246121
	5673-11	AC 100...240 V Class1/Div.1 in EEx-d- casing 1 channel pre-installed	242057
	5673-12	DC 10...36 V Class1/Div.2 1 channel pre-installed	246119
	5673-13	DC 10...36 V Class1/Div. 1 in EEx-d- casing 1 channel pre-installed	242056
<b>Accessories for evaluation unit</b>			
	5673-110	Plug-in interface	281686
	5673-114	Channel board	287836
	5673-115	Relay board	289079
	5673-106	Plug-in interface	242082
	5673-107	HCDT-sensor plug-in unit	246120
<b>Sensor for measuring the dew point of hydrocarbons</b>			
	1510-11		276 644
<b>Humidity sensor with integrated Pt 100</b>			
Diameter of measuring tube 10 mm, 100 bar, calibrated from – 80...+ 20 °C DT			
	L 1661	Immersion depth 36 mm	287782
		Immersion depth 100 mm	281278
		Immersion depth 225 mm	302470
		Immersion depth 225 mm RT (for retraction tool)	302471
		Special calibration in natural gas (with DAP calibration certificate, calibrated from –20° C, –10° C, 0° C DT, at 41 bar)	232340
		Special calibration in hexane (freely selectable measurement range)	232165
		Special calibration in several gases and liquids (freely selectable measurement range)	239 022
		Protection cap with Teflon filter 10 µm	304746
<b>Fibre-optic combination cable</b>			
Including ST plugs and adapters, 2 optical fibres + 6 Cu leads for Pt 100 and pressure sensor, shielded, protected and flame-retardant according to IEC 332-3A, field fit			
	1631-112	Length 2 m	242445
		Length 5 m	247283
		Length 10 m	245449
		Length 20 m	240821
		Length 100 m	239954
		Special lengths in 5 m steps up to 100 m Special lengths in 10 m steps, from 100 m upwards max. length: 800 m	
<b>Combined fibre-optic cable with extended temperature range</b>			
Including ST plugs, 2 optical fibres + 6 Cu leads for Pt 100 and pressure sensor, shielded, protected and flame-retardant according to IEC 332-3A, suitable for field application, temperature range from -55°C to 70°C			
	1631-113	Special lengths in steps of 5 m, up to 100 m Special lengths in steps of 10 m, from a length of 100 m (Max. length 800 m)	XXXXXX

<b>Designation</b>	<b>Type</b>	<b>Specification</b>	<b>Order No.</b>
<b>Accessories</b>			
Power Supply	1510-100	DC 24 V	279810
	1510-101	AC 100...240 V	286340
	1510-104	AC 100...240 V with shaft temperature tracking	337994
Fuse T 2A		Fuse SI 1 for Power Supply 1510-100 Ø5x20mm, Littelfuse p/n 218	106626
Fuse T 1A		Fuse SI 6 for Power Supply 1510-100 Ø5x20mm, p/n Littelfuse no. 215	120463
Gas- Liquid-separator	5672-129		287907
<b>Test equipment</b>			
Moisture generator	DPG-59	Approx. 20ppm / 50ppm / 100ppm	239 611



**You can request further spare parts lists  
from customer service!**





## 2 Safety precautions

The evaluation units are produced in line with the regulations currently in force and have left the factory in perfect condition after having undergone thorough safety tests.

- Installation and maintenance of the evaluation units to be carried out by qualified staff.
- Make sure that the data and operating conditions specified by BARTEC BENKE are observed.
- Study the operating instructions before installing and starting up the system. If you have any questions concerning any particular aspects, contact our customer service for expert advice.
- The HYGROPHIL® F 5673 is an optical precision instrument. It is essential therefore to protect it from knocks and jolts during transportation and to select a point of installation unaffected by vibrations.
- Instruct your operating and maintenance personnel thoroughly and provide them with all essential information.
- The system's internal error messages are no replacement for safety devices in the larger facility in which the evaluation system is integrated.
- It is imperative to observe all the regulations which govern the operation of your facility.
- Before connecting the power supply, make sure that the evaluation unit's operating voltage (see the type plate) matches the actual supply voltage.
- In the event of trouble, make a note of all the error messages in the display and check whether they can be remedied. If local repair is not possible, send the unit for repair to BARTEC and include full details of the fault.
- Take the unit out of operation immediately and secure it against being started up again accidentally if there is any reason for supposing that it can no longer be used safely (e.g. visible signs of damage).



Do not open the casing of the evaluation unit!  
All works requiring the evaluation unit to be opened are reserved strictly for qualified technical staff.

- Keep the moisture-sensitive layer of the sensor free of contamination from oil and grease.
- Use the supplied guard caps to protect the open light waveguide connectors on the evaluation unit and the sensor during transportation and storage.
- Take care not to kink the light waveguides and not to bend them to a bending radius of less than 20 mm.

## Instructions for the safe usage of the device

- The humidity measurement sensor is installed in the partition wall of the zone which in accordance to the definitions of device group II requires category 1 equipment (zone 0).
- For the application as category 1 equipment, the ambient conditions of the humidity measurement sensor have to comply with the atmospheric conditions in accordance with EN 50284 (temperature range from  $-20^{\circ}\text{C}$  to  $+60^{\circ}\text{C}$ , absolute pressure range from 0.8 bar to 1.1 bar). The humidity measurement sensor can also be applied as category 2 equipment in zone 1 at an ambient temperature  $T_a$  or a medium temperature  $T_M$  ranging from  $-30^{\circ}\text{C}$  to  $+60^{\circ}\text{C}$ .
- If the device is installed in systems with the risk of overvoltage, carry out measures in accordance with EN 60079-14, para. 12.3 ! (also see DIN VDE 0185)
- Humidity measurement sensors of the types L166x involve the risk of an electromagnetic charging of the plastic casing! Only use a moistened cloth to clean the casing!
- A minimum distance of 1 mm must be maintained between the housing of the moisture meter type L1661 and possible grounded metal parts in the immediate vicinity of the housing.
- The intrinsically safe circuits of the HYGROPHIL® F are galvanically separated up to  $V_m = \text{AC } 253 \text{ V}$  (also see EN 60079-14, para. 12.3).
- If the device is installed in pressure lines or pressure vessels, make sure the appropriate specifications (pressure vessel regulation DruckbehV, TRG, GasHL-VO, TRGL, ...) are complied with!
- The humidity measurement sensor has to be included in the respective tightness and pressure tests.
- Usually an adapter with a screw thread is applied between the double-ferrule swage fitting of the humidity measurement sensor and the facility. On the facility side at least 5 threads of this adapter must be operative.
- Mounting the double-ferrule swage fitting:
  - First rotate the nut fingertight. If necessary tighten the nut by using a spanner until the measurement tube will not turn by hand.
  - Mark the nut in the 6 o'clock position.
  - While holding the fitting body steady with a spanner tighten the nut with a second spanner one and one-quarter turns to the 9 o'clock position (see also section 3.3.3).
- Only use BARTEC-fibre-optic cables (see accessories).
- Make sure the cable of the intrinsically safe PT100 circuit and of the intrinsically safe pressure transmitter circuits are correctly laid. Do not lay the cables together with power supply cables in joint cable channels. Make sure there is a sufficient distance from electromagnetic interference fields! To prevent any potential equalisation currents, tie the port of the shielding to GND at only one place.
- In the construction of the humidity measurement sensor, epoxy resins are used. They are usually resistant to the mediums mentioned in the resistance list (see table p. 2-4). In case of application as category 1 equipment in other mediums, the resistance has to be checked separately.



- The sensor of HYGROPHIL HCDT 1510-11 can be installed into the partition to the area, that require devices of equipment group II, category 1 (zone 0)
- For applications requiring category-1-equipment, the process pressure of the media shall range from 0.8 bar to 1.1 bar. The ambient temperature shall range from -20°C to +60°C
- Installations in facilities with potential danger of overvoltages require provisions according to EN 60079-14:1997, clause 12.3.
- Installations in pressure vessel or pipes may require application of appropriate standards and rules (DruckbehV, TRG, GasHL-VO, TRGL, ...)
- The sensor of HYGROPHIL HCDT 1510-11 has to be included in appropriate pressure test of the facility.
- The construction of HYGROPHIL HCDT 1510-11 sensors uses epoxy resin. These are resistant to the media mentioned in the table 1. Applications in other media require a separate resistance test.
- The cable between the sensor and the measuring unit has to be installed fixed. An appropriate protection against mechanical impacts shall be provided (see EN 60079-14: 1997, clause 12.2.2.8).
- The cable between the sensor and the measuring unit is connected permanently. Disconnection and replacement of this cable can only be done by the manufacturer. There is a potential danger, when the pink wire of the I.S. peltier circuit at terminal 10+ is swapped with the gray wire at terminal 11+.
- The shield of the cable between the sensor and the measuring unit is connected to the metal enclosures on both sides. This shield connection between sensor and measuring unit will provide electrostatically discharge of the sensor enclosure, if it is installed isolated and there is potential danger of electrostatically discharge.
- The installation location of sensor and measuring unit have to be at same electrical potential, if necessary locations have to be included in local equipotential bonding.

<b>List of resistance for application of category-1-equipment</b>	
Alkohole	alcohols, generally
Ammoniak NH <sub>3</sub>	ammonia
Argon	
Äthanol	ethyl alcohol
Chlor	chlorine
Distickstoff-Monoxid	
Druckluft	compressed air
Erdgas	natural Gas
Ester	ester
Flüssigkeiten	liquids, generally
Flußsäure H	hydrofluoric acid
Helium	
Hexan	hexane
Kerosin	kerosens
Kohlendioxid CO <sub>2</sub>	carbondioxide
Kohlenmonoxid CO	carbonmonoxide
Kohlenwasserstoffe	hydro carbons, generally
Krypton	
Lachgas	Nitrous oxide
Methan	methane
Methanol	methyl alcohol
Methylenchlorid	
Naphtha	naphtha
Narkosegas	narcotic gas
Neon	
Propan	propane
Raffineriegas	refinery gas
Sauerstoff	oxygen
Schwefelhexafluorid SF <sub>6</sub>	
Schwefelwasserstoff	hydrosulphide
SF <sub>4</sub>	
Silikonöl Dämpfe	Silicon vapours
Stickoxid	nitric oxide
Stickstoff	nitrogen
Toluol	
Vinylacetat	
Wasserstoff	hydrogen
Xenon	
Xylol	

*Exclusion of liability*

BARTEC BENKE GmbH and its agents shall be liable only for damage caused by gross negligence or intent. Said liability shall be limited to the value of the order in question issued to BARTEC BENKE GmbH.

In particular, BARTEC BENKE accepts no liability for damage resulting from non-observance of the safety information or from non-compliance with the operating instructions or operating conditions.

Liability for consequential damage is excluded.

## 3 Installation

### 3.1 General

- Before installing the evaluation unit, make sure that your supply voltage is the same as that set on the evaluation unit (AC 100...240 V or DC 10...36 V).
- If you want to use the output signals from the analog output and relay outputs to control any processes, signaling devices or the like, install the necessary wiring
- Remove the guard caps from the tip of the sensor, the light waveguide connectors and the ports on the back of the evaluation unit.

### 3.2 Arrangements for EMC

Ferrite noise filters (order no. 275368) must be fixed to the cables according to the specifications in the technical data of the plug in units.

After locking the plug contacts the filters may no more shift.

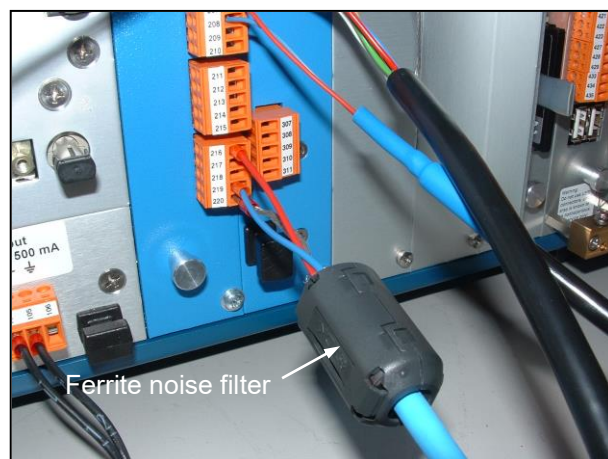

Included in delivery are 5 ferrite noise filters. If you need some more, you can order them (order no. 275368).

You can also order other types for different diameters of cables.



**When connecting the shielded cable, observe the current electronic plans in your customer file.**

## 3.3 Sensor L166x

### 3.3.1 Wiring the sensor L166x

- Remove the 4 screws and open the casing.

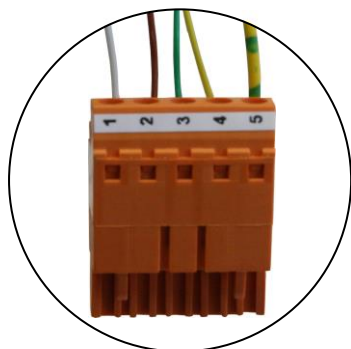

- Connect the Pt 100 cable first. Connect the terminals 1 to 5 in the sensor casing to the terminals 201 to 205 at the back of the evaluation unit (see fig. at following page).

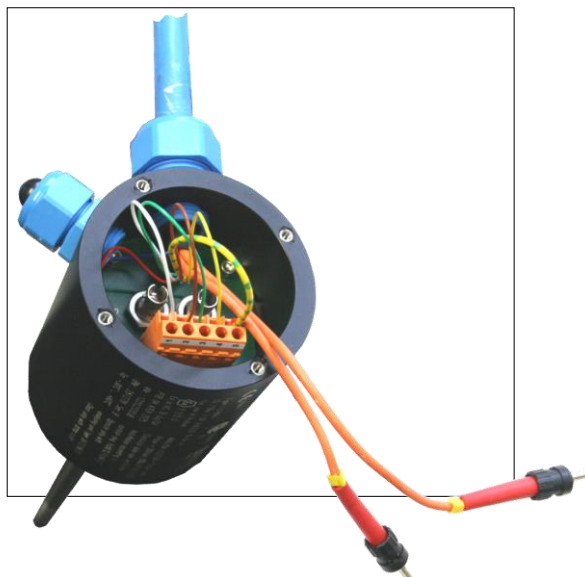

Plug Sensor FOC	Allocation	Colour	Plug (Ev. Unit)
1	Moist.sensor	OG	1
2	Moist.sensor	OG	2

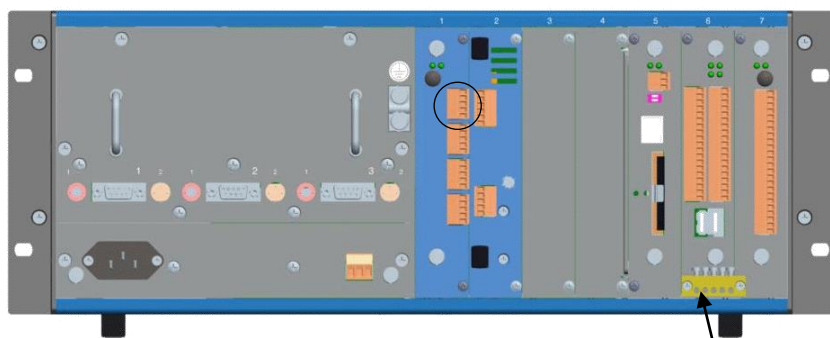
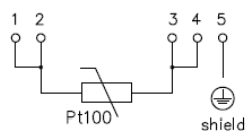
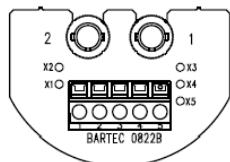

Clamp Sensor Pt100	Signal	Colour	Clamp Ev. Unit
1	I_Out_Pt100	WH	201
2	IN+_Pt100	OG o. BN	202
3	IN-_Pt100	GN	203
4	GND_Pt100	YE	204
5	Shield	BK	205

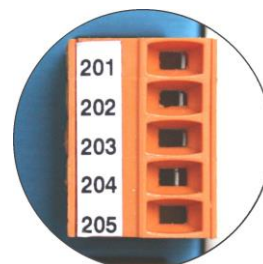

GR external shield of fibre optic cable

- Connect the fibre optic cable (bayonet connectors). The numbers 1 and 2 on the fibre optic cable have to tally with the numbers 1 and 2 at the connections in the casing. Let the cables make a bend from the entry to the ST coupling!

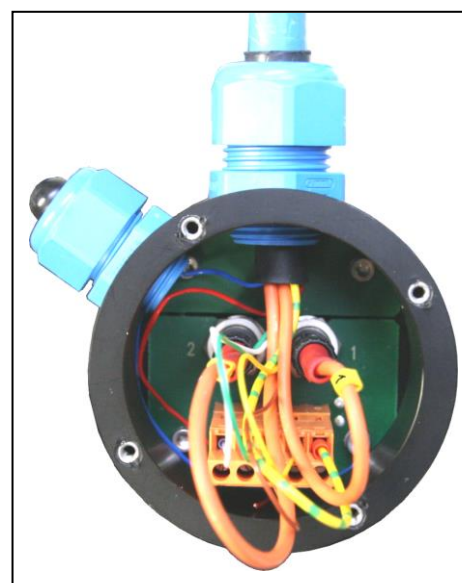

To protect the surface of the ST adapters remove the guard caps only directly before connecting!

- Tighten the union nuts. Pay attention to a good sealing by the rubber plugs.
- Close the casing and fix it by the 4 screws.

- Connect the two ST- connectors which are at the other ends of the fibre optic cable to the connector plug at the back of the evaluation unit (bayonet connectors).

The numbers 1 and 2 on the fiber optic cable have to tally with the numbers 1 and 2 on the evaluation unit.

- Connect the connector plug of the humidity sensor in the corresponding port.

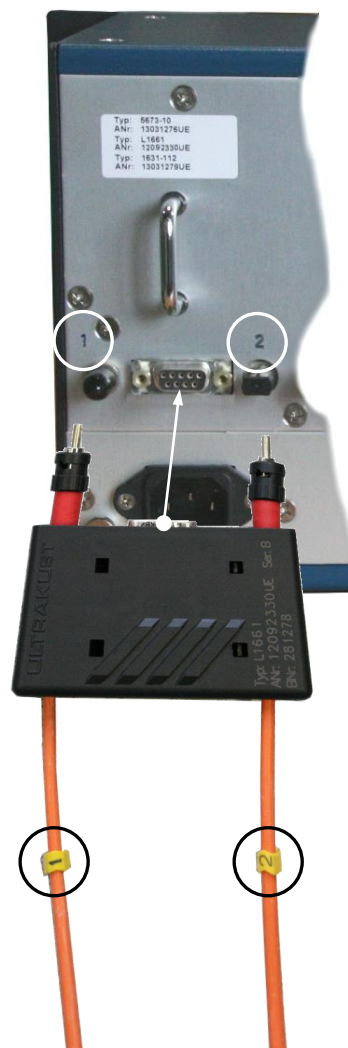

The “A” numbers of the sensors, the connector plugs, the fibre-optic waveguide cables and the evaluation unit have to tally with the corresponding “A”-numbers on the system plate of the evaluation unit (see the illustration next page).



**CE** 0044  
**BARTEC**  
**D-94239 Gotteszell**  
 Typ: 5673-10  
 ANr: 13021605UE  
 BNr: 284492  
 Ta: +5 °C...+50 °C  
 Electrical rating see power supply module

Type plate (evaluation unit)



Typ: 5673-10  
 ANr: 13021605UE  
 Typ: L1661  
 ANr: 12092330UE  
 Typ: 1631-112  
 ANr: 11040002UE

System plate (evaluation unit)



### 3.3.2 Installing the sensor L166x

Installation in an analysis pipe via Sample cell „Gas- Liquid-separator“  
 Type: 5985-00-003

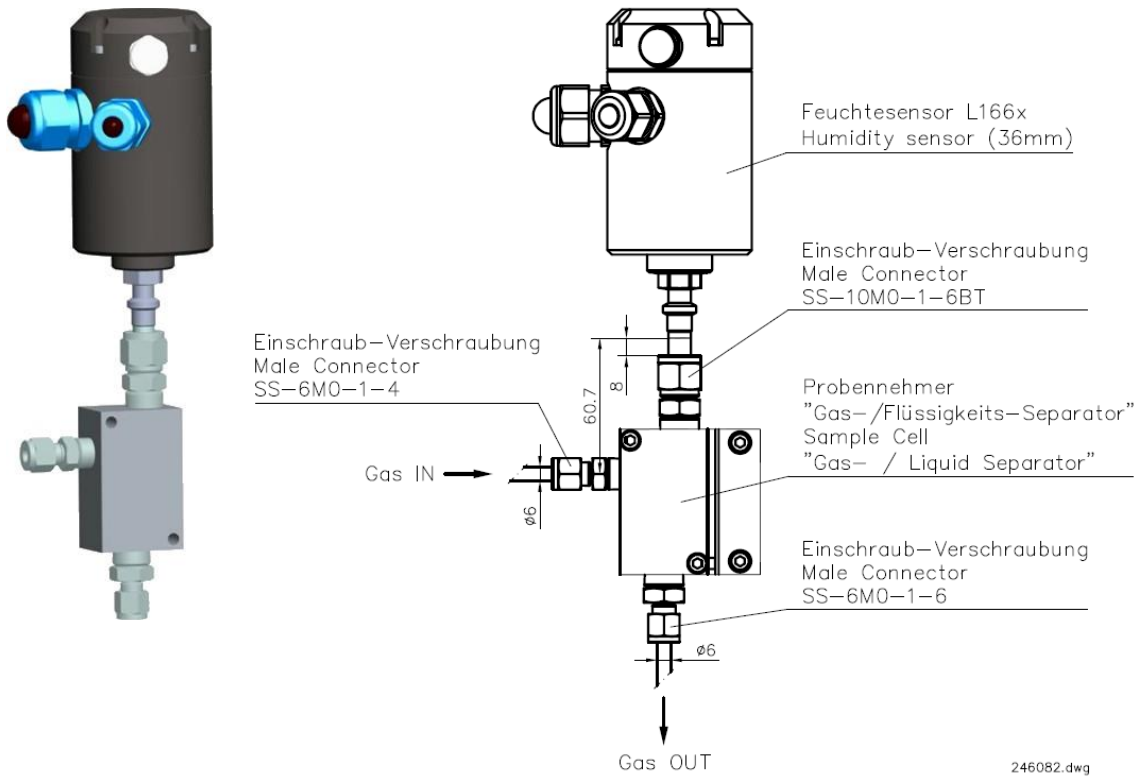



### 3.3.3 Installation advice

Before installing the sensor make sure that the stainless steel protection cap is screwed tightly to the tip of the sensor.

The sensor L166x can be fitted with any suitable compression type fitting.

Never mount the ferrules within the distance of 50 mm, measured from the sensor tip (incl. protection cap) !

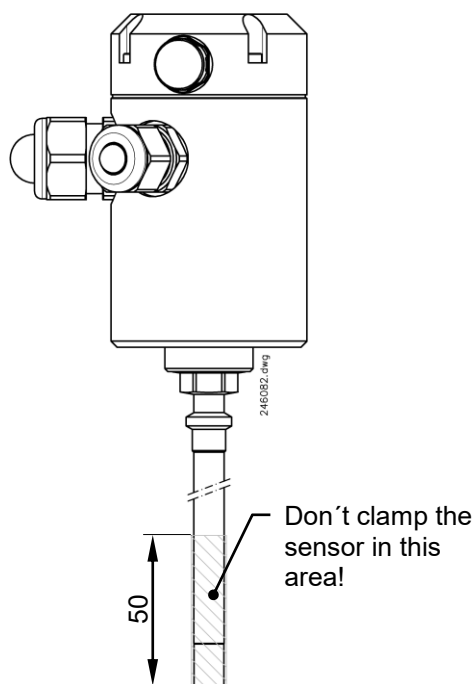

The following sequence describes the procedure to install the sensor in the gas-/ liquid-separator with Swagelok fittings.



1. Assemble union nut with back and front ferrule on the connector. Make sure that both ferrules are fitted correctly.
2. Insert the sensor in the union nut until the tip of the sensor hits the bottom of the sample cell.
3. Mark the immersion depth with a pen approx. 1 mm above the union nut.
4. Lift the sensor appr. 8...10 mm.

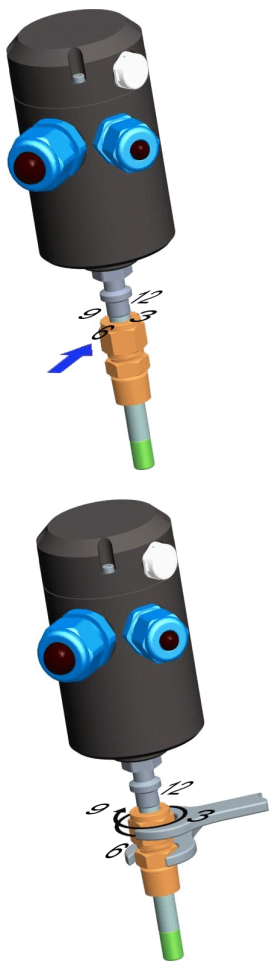
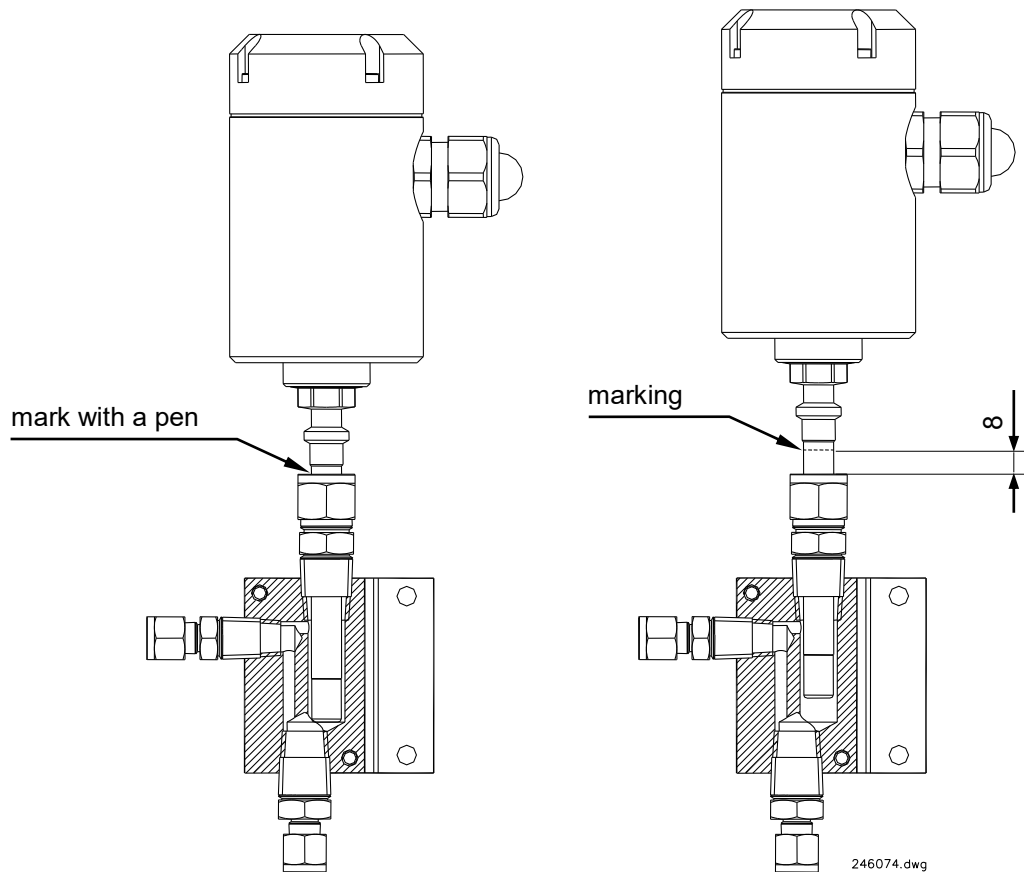

5. Tight the union nut according to the procedure of the compression type fitting manufacturer:

- First rotate the nut fingertight. If necessary tighten the nut by using a screw-wrench until the measurement tube will not turn by hand.
- Mark the nut in the 6 o'clock position.
- While holding the fitting body steady with a screw-wrench tighten the nut with a second screw-wrench one and one-quarter turns to the 9 o'clock position.

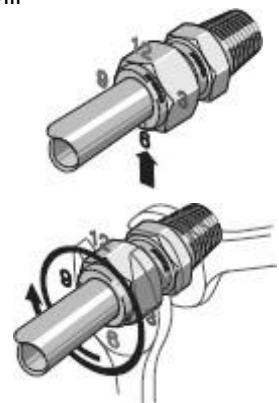

## 3.4 HCDT Sample system types 5985-7x/8x/9x

To measure the dewpoint of hydrocarbons is the sensor HYGROPHIL HCDT 1510-11 integrated in a sample system.

The sample systems are optionally available with ATEX-certification or with CSA-certification.

Both variations are equipped with a Peltier-cooling. As an additional option the system can be fitted with a heating.

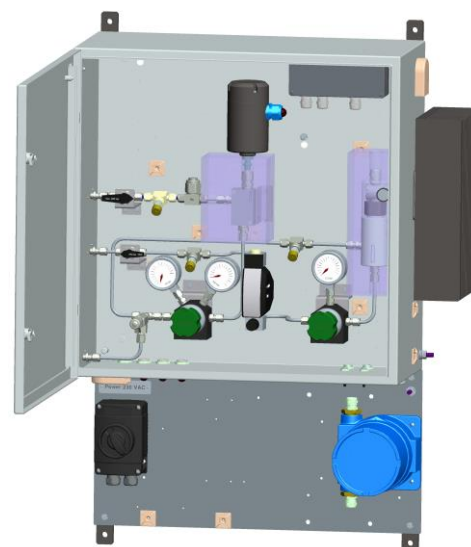

*Sample system with Peltier-cooling*

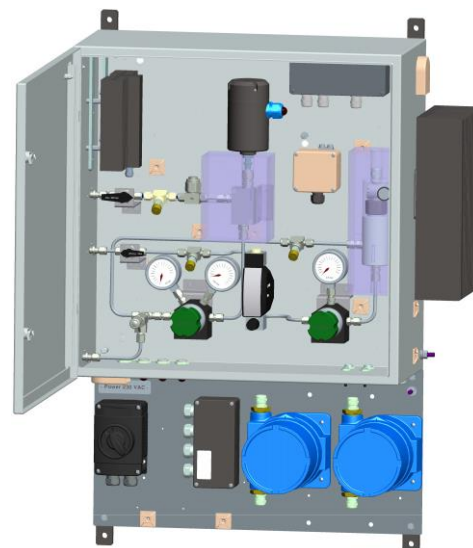

*Sample system with Peltier-cooling and heating*



**For all shielded cables between HYGROPHIL F and the sample system always apply the shielding to one side. Observe the current electronic plans in your customer file.**

**In the sample system, the cables are already prefabricated. The shielding cannot be applied there.**

## 3.4.1 Drawings

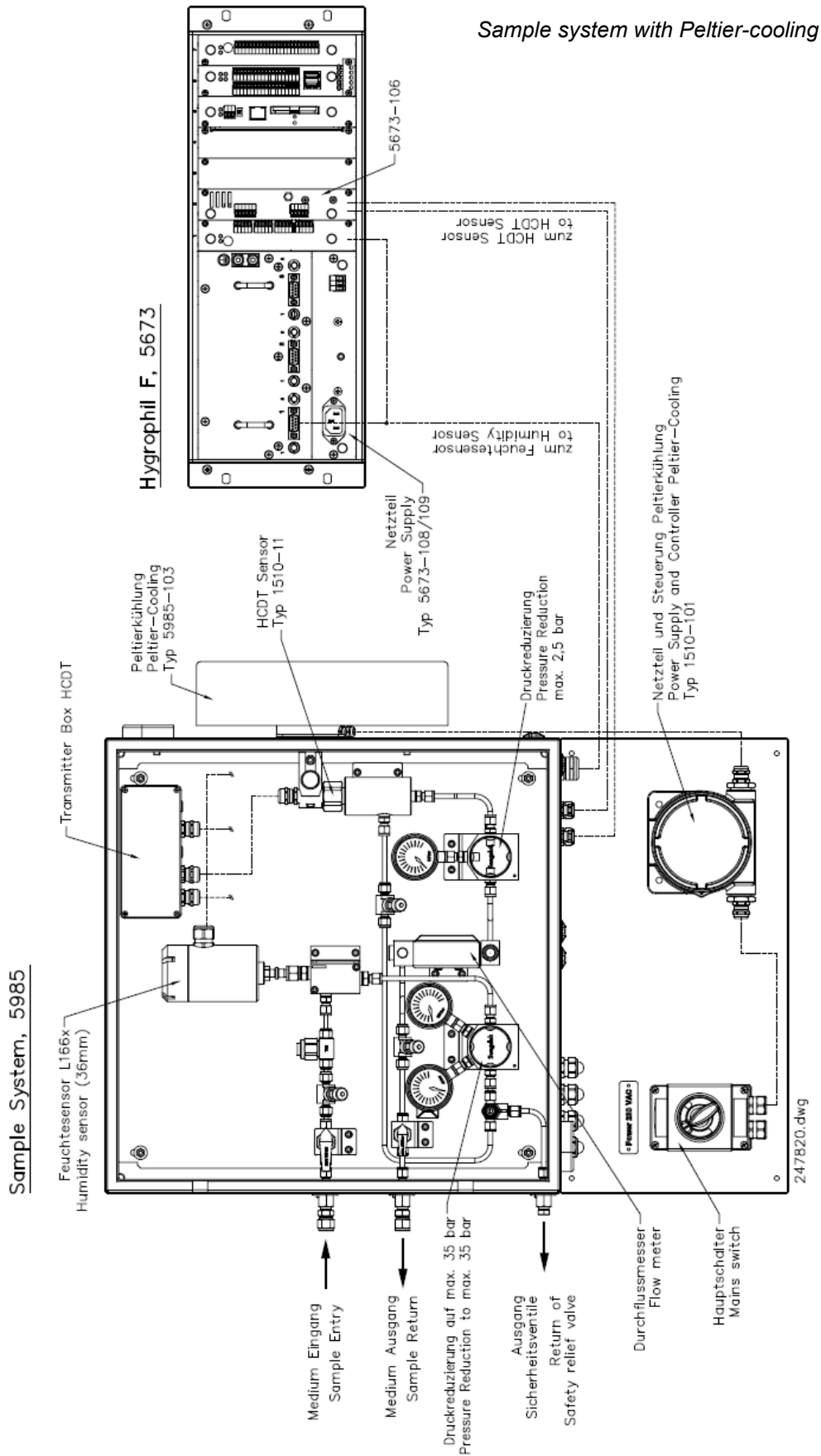

**Sample System, 5985**

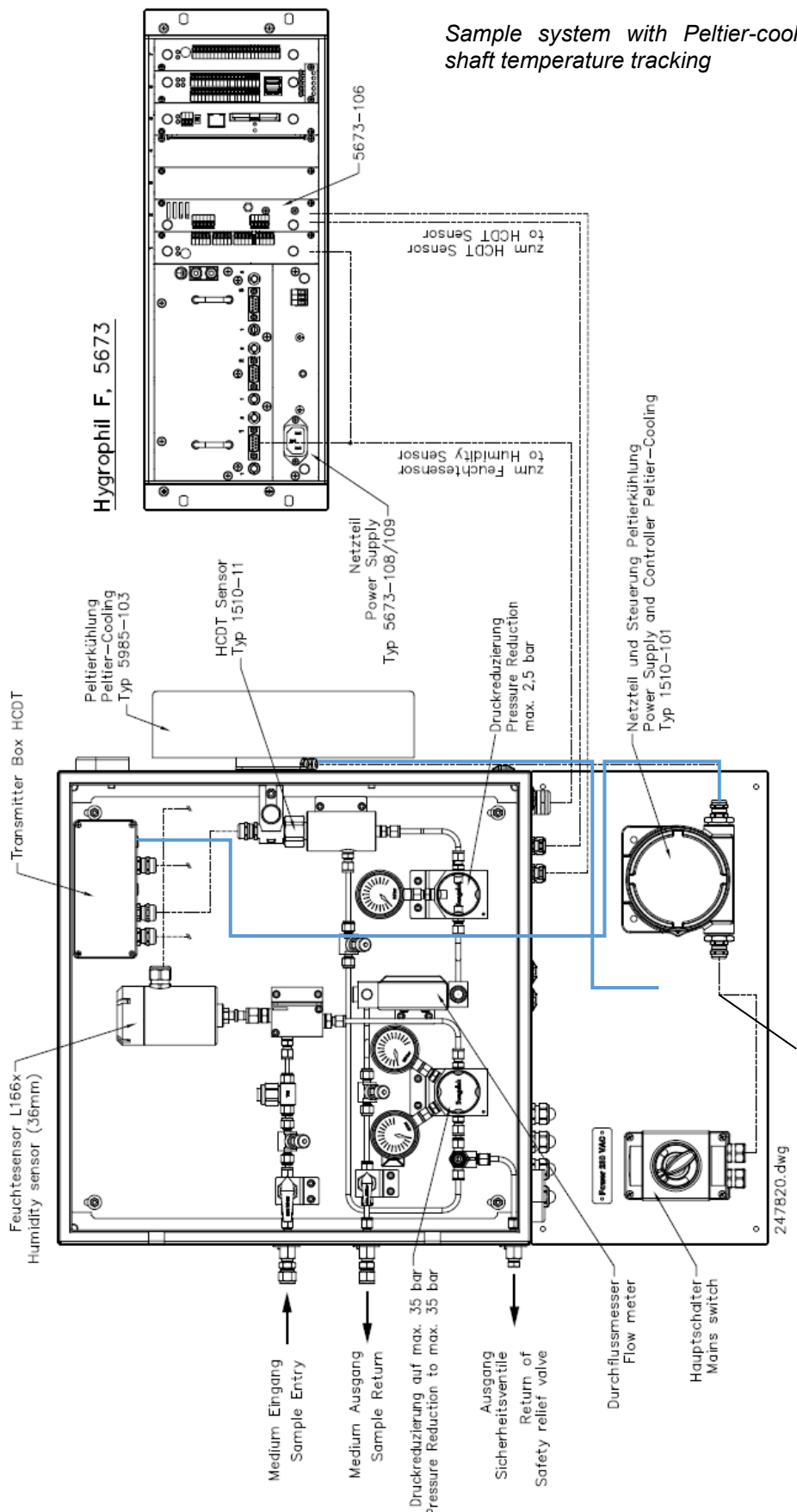

*Sample system with Peltier-cooling and shaft temperature tracking*

Sample System, 5985

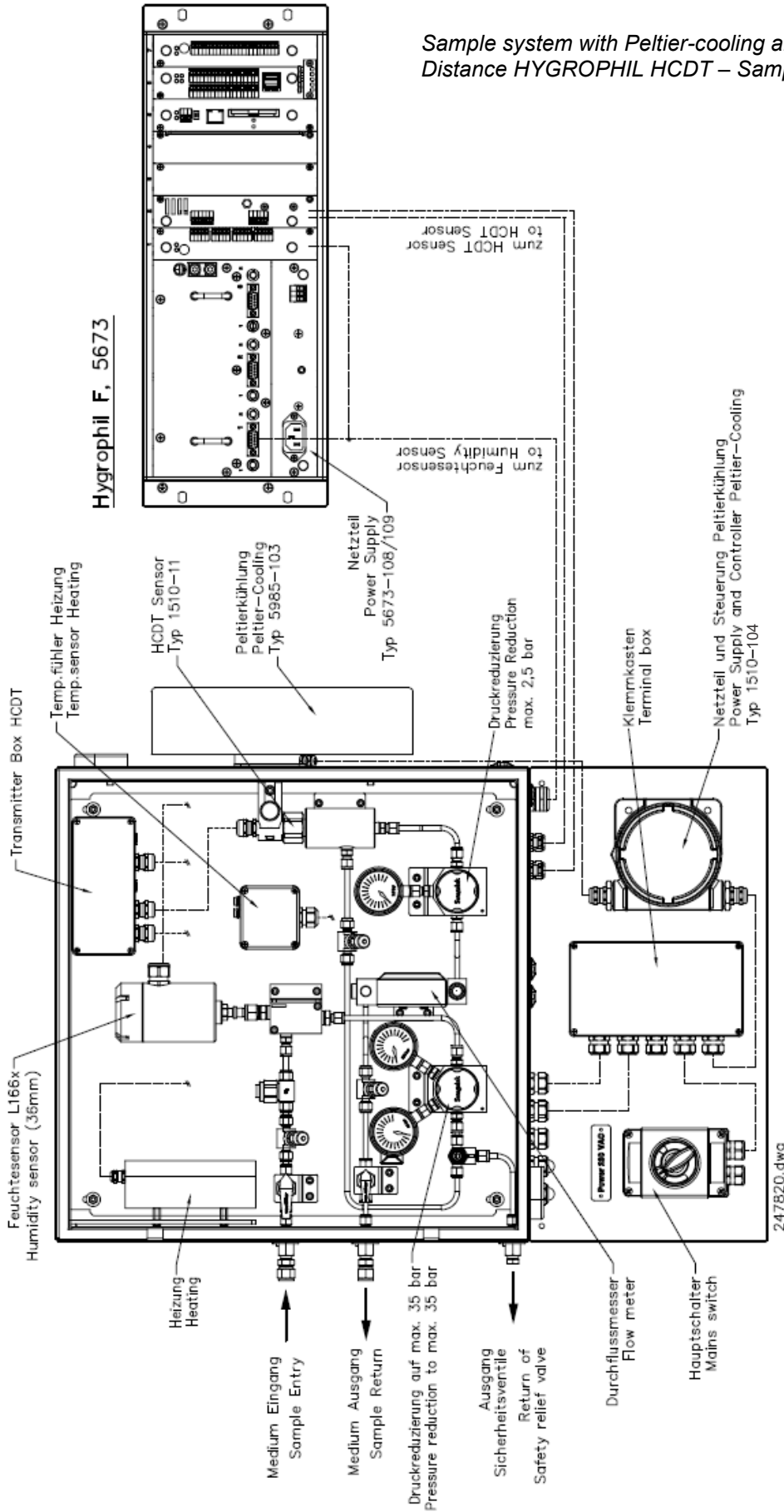

Sample system with Peltier-cooling and heating  
Distance HYGROPHIL HCDT – Sample-System ≤ 20m

Sample System, 5985

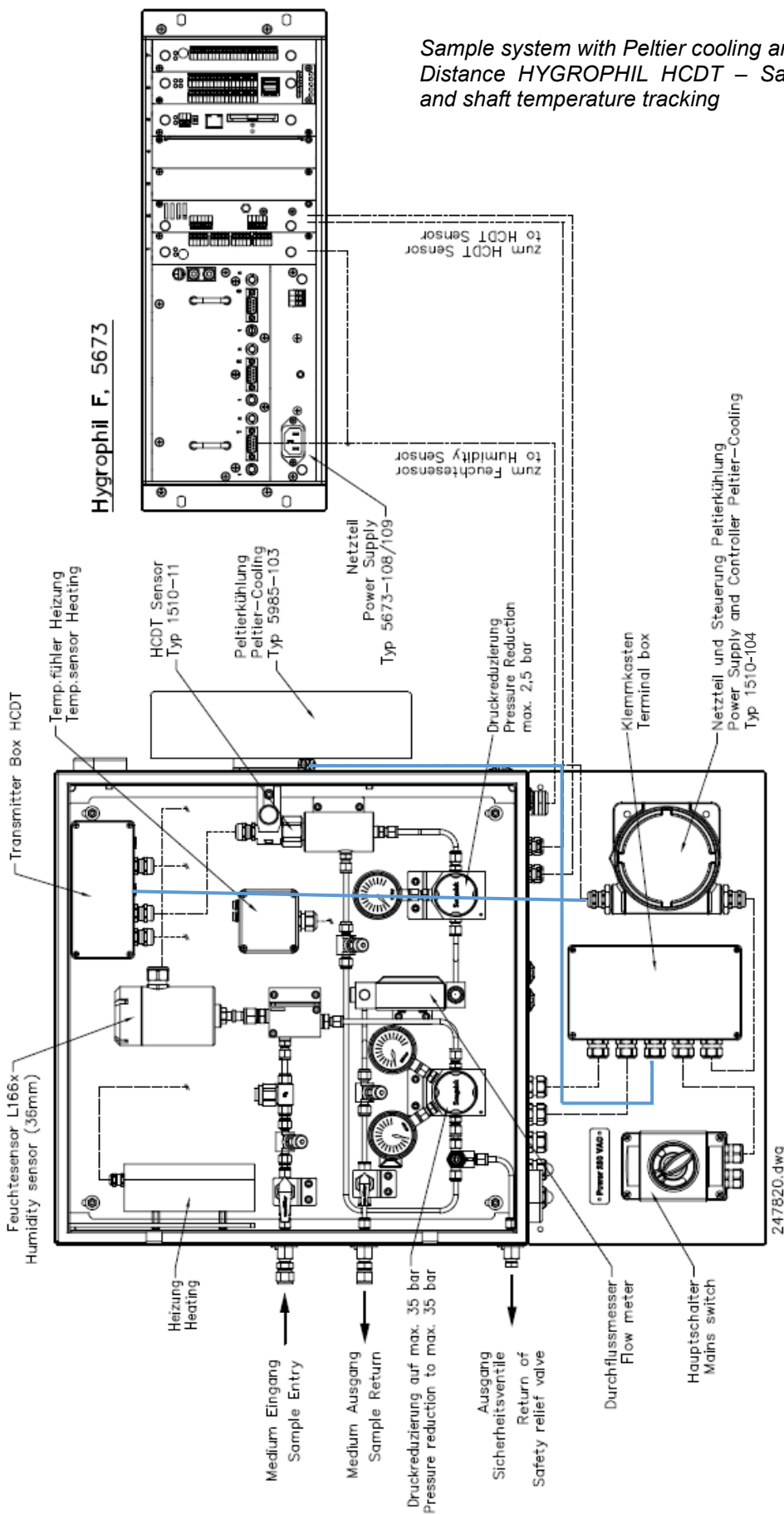

Sample system with Peltier cooling and heating  
 Distance HYGROPHIL HCDDT – Sample-System ≤ 20m  
 and shaft temperature tracking

**Sample System, 5985-70**

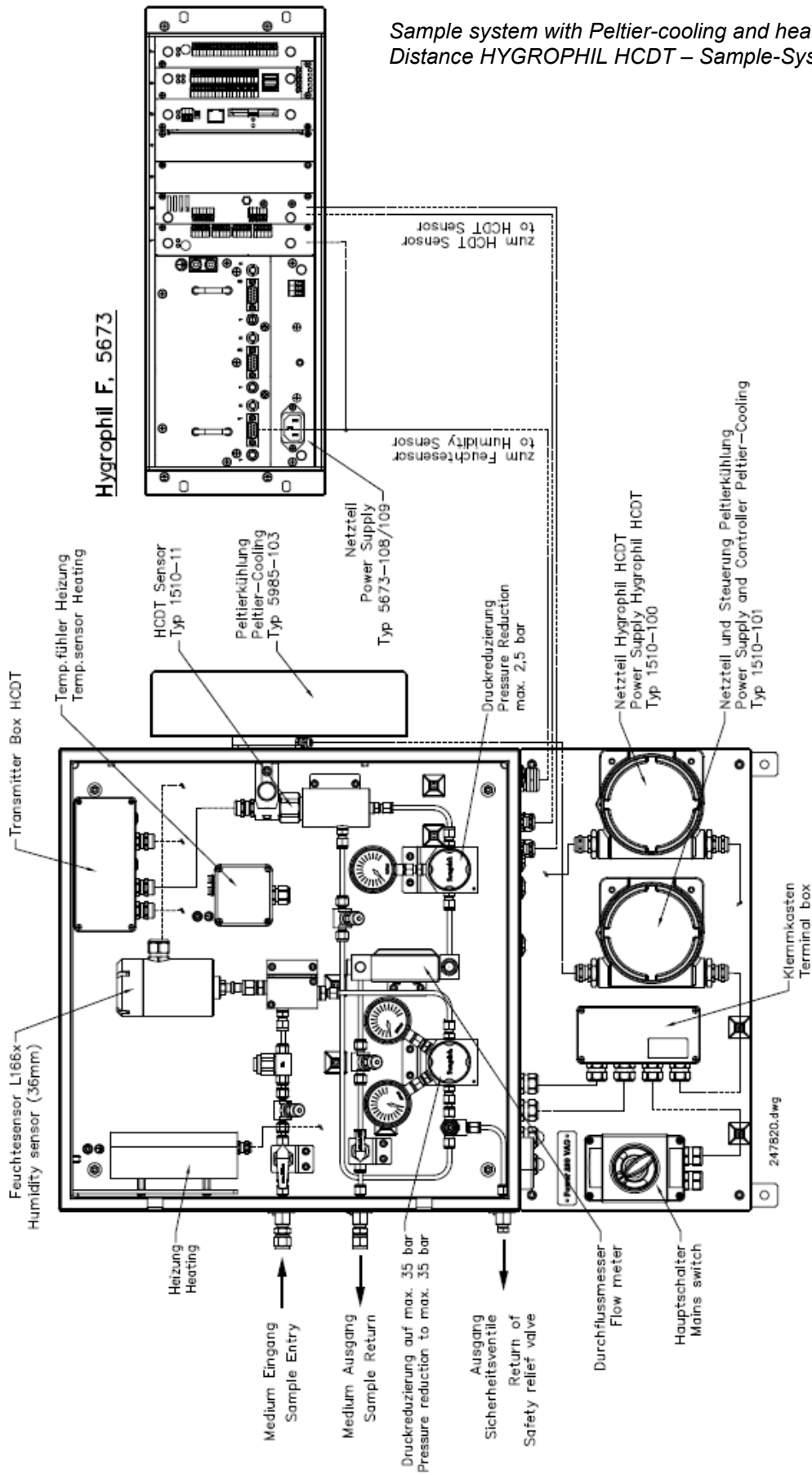

Sample system with Peltier-cooling and heating  
Distance HYGROPHIL HCDDT – Sample-System  $\geq 20m$

**Hygrophil F, 5673**

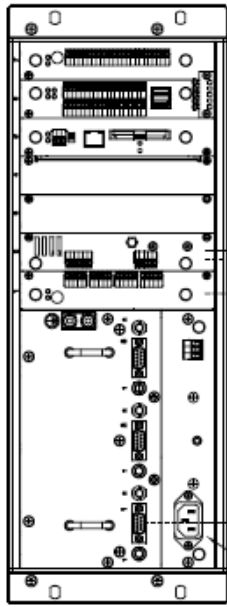



**Sample System, 5985-70**

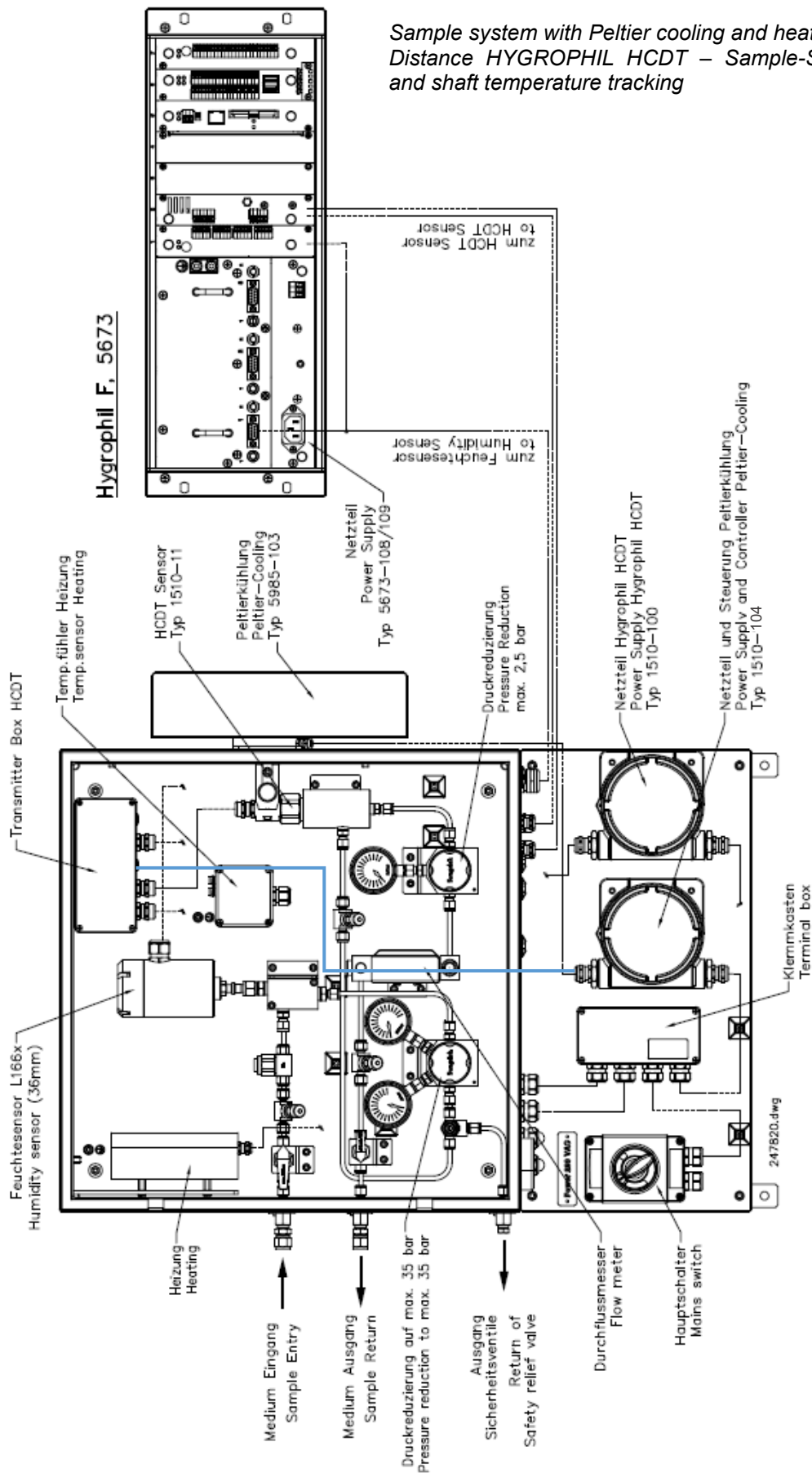

**Hygrophil F, 5673**

Sample system with Peltier cooling and heating  
 Distance HYGROPHIL HCDDT – Sample-System ≥ 20m  
 and shaft temperature tracking

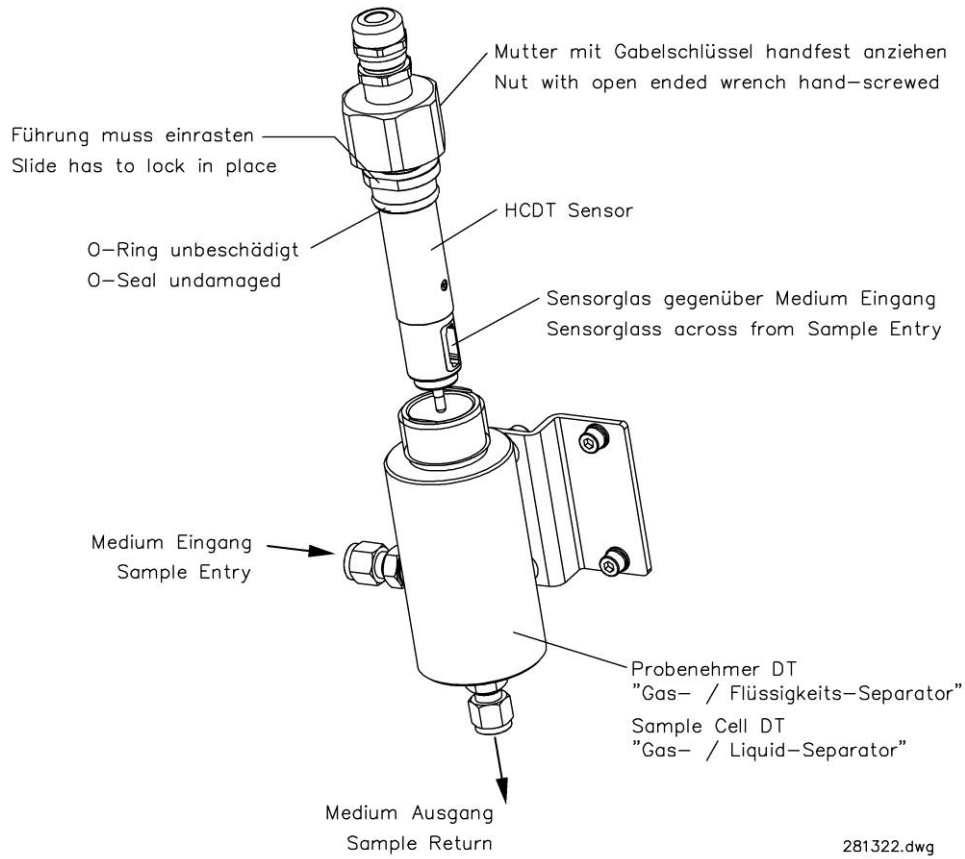

Transmitter and Sensor Type 1510-11  
(Dimensions in mm)

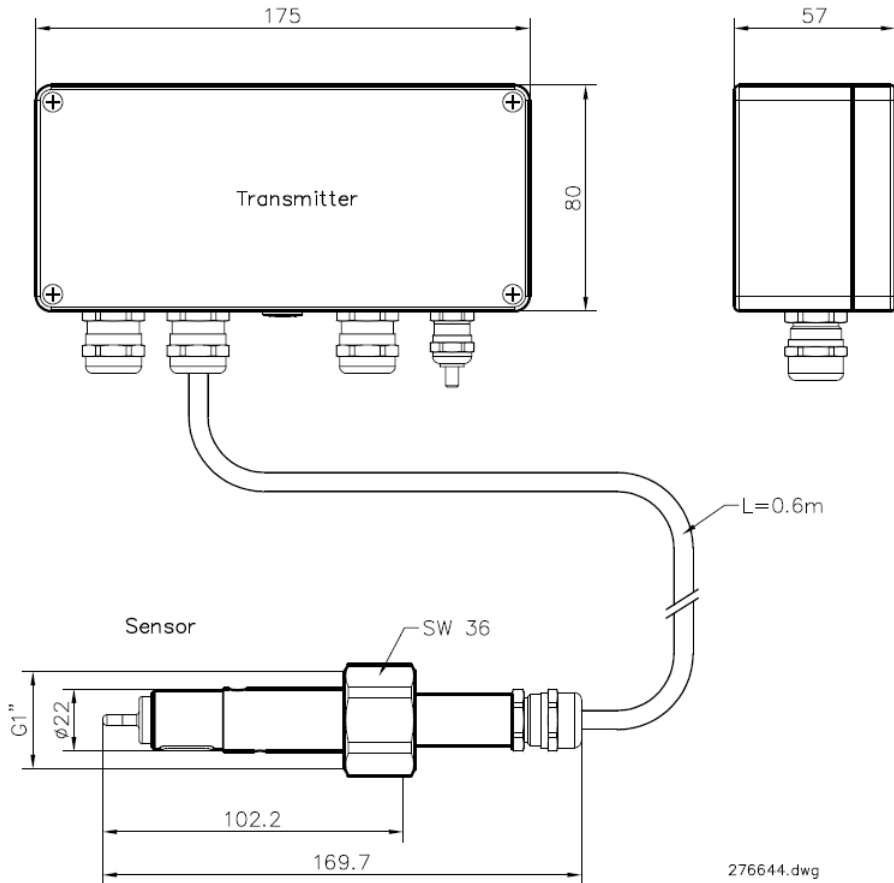

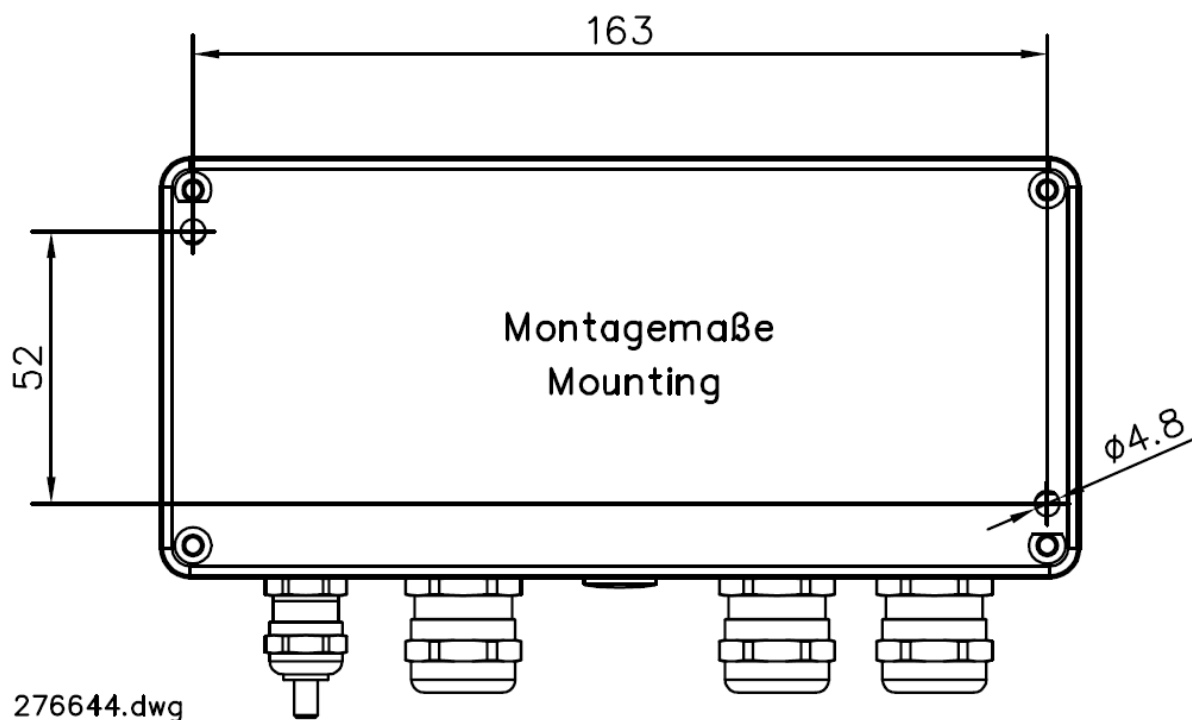

Cable connection  
see inside the cover

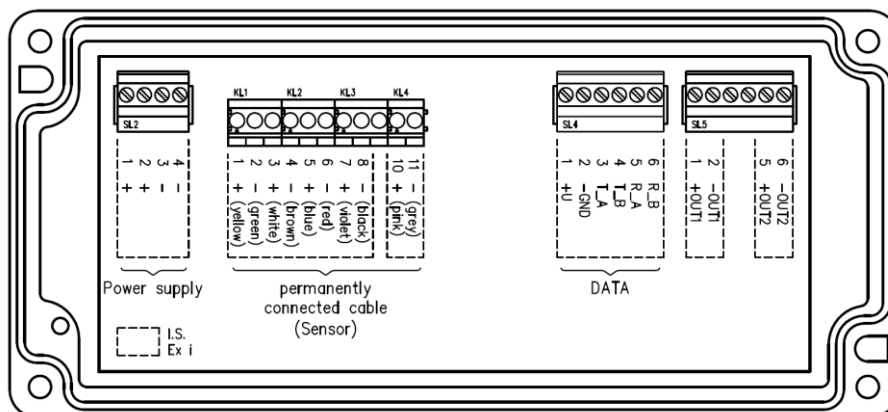

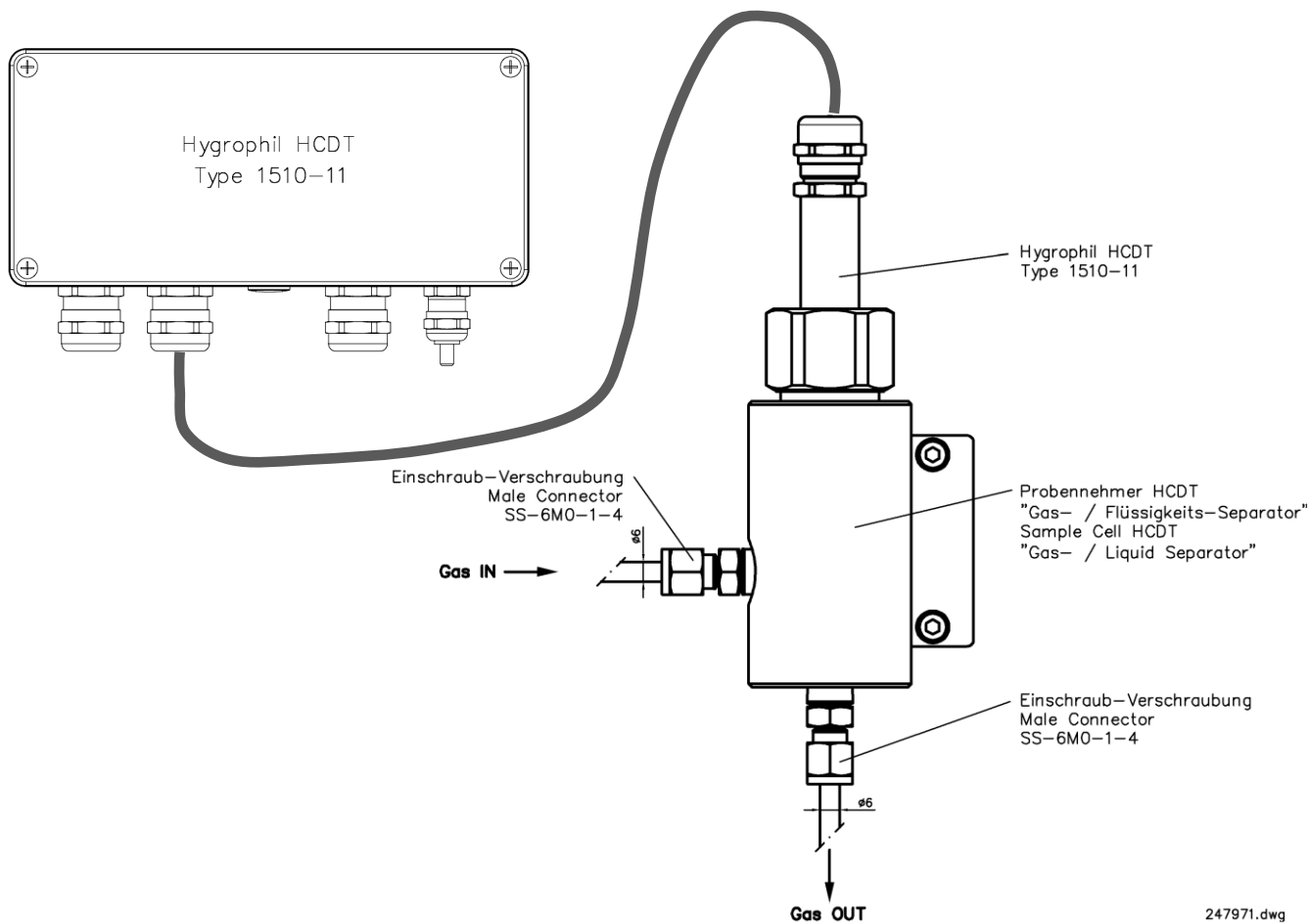

If the line between evaluation unit and sample system is longer than 20 m you must install the additional power supply (type 1510-100) (see following figures).



**CAUTION!** An external potential equalization must be ensured between the housing of the terminal box and the sensor. Otherwise, there is a risk of explosion.

### 3.4.2 Wiring

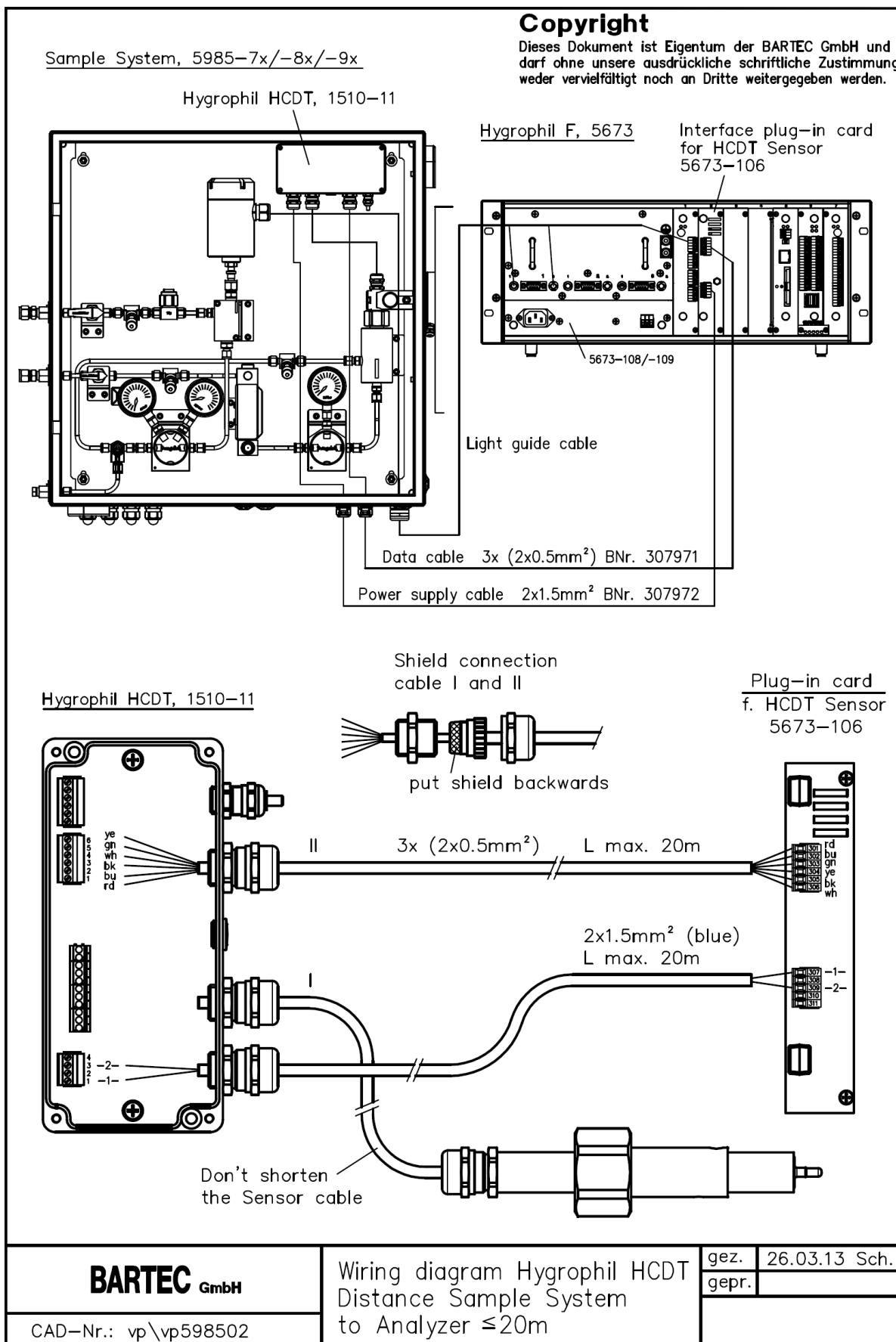

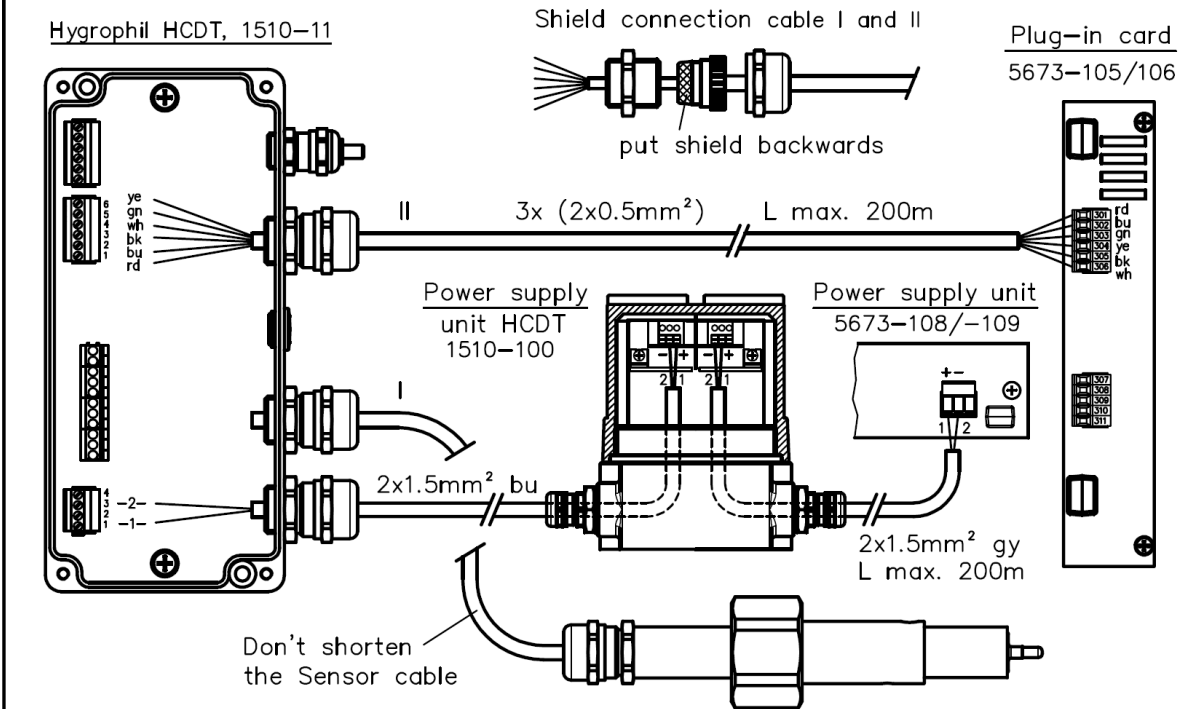
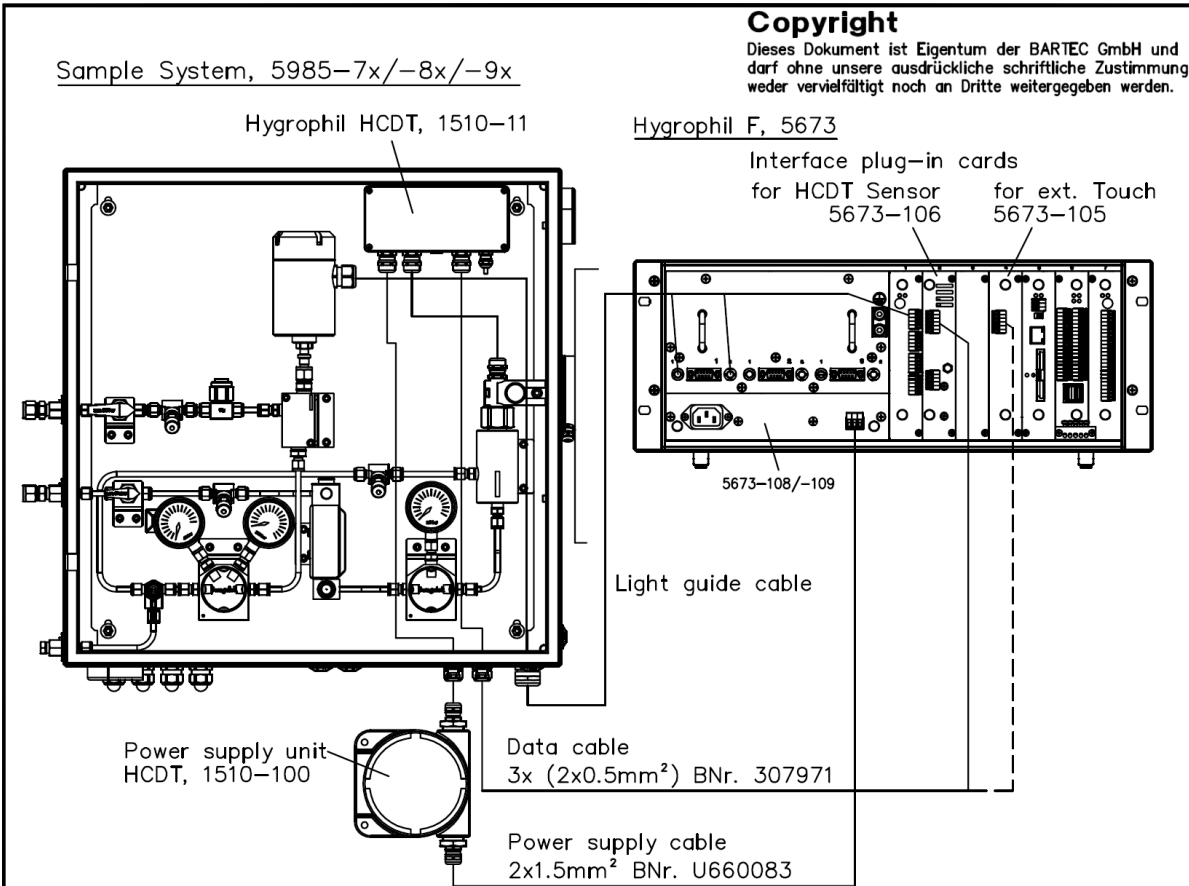

<b>BARTEC</b> GmbH CAD-Nr.: vp\vp598503	Wiring diagram Hygrophil HCDT Distance Sample System to Analyzer >20m	gez. 26.03.13 Sch.
		gepr.

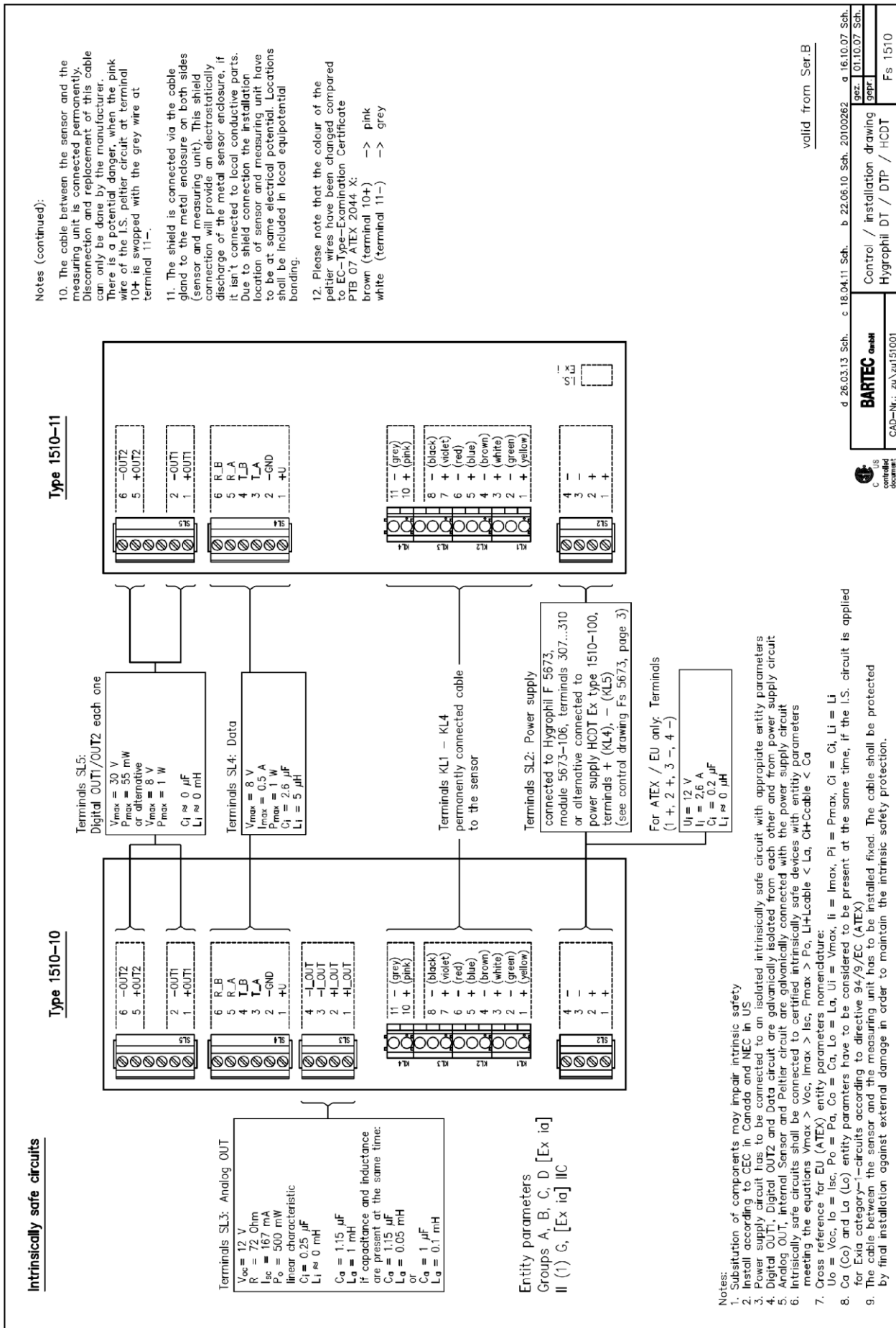

### Wiring the power supply type 1510-100

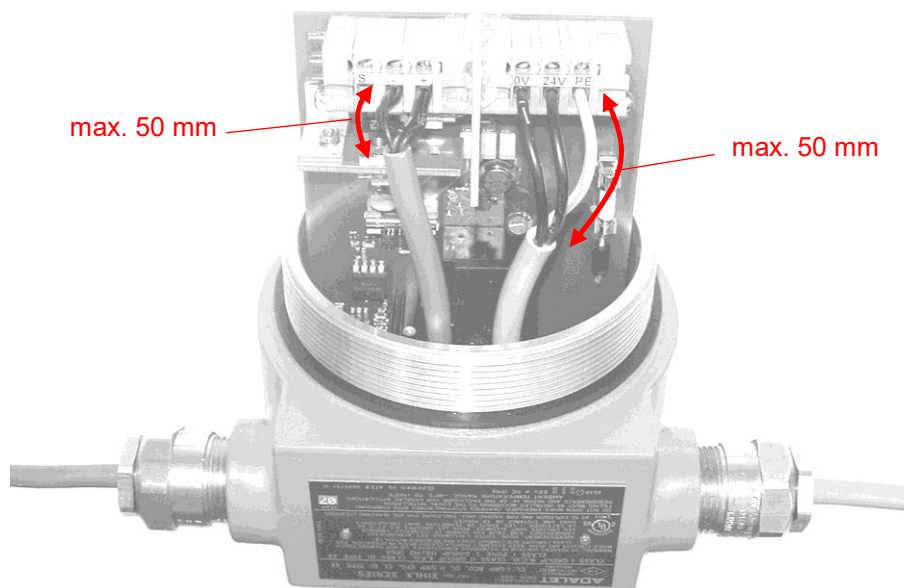
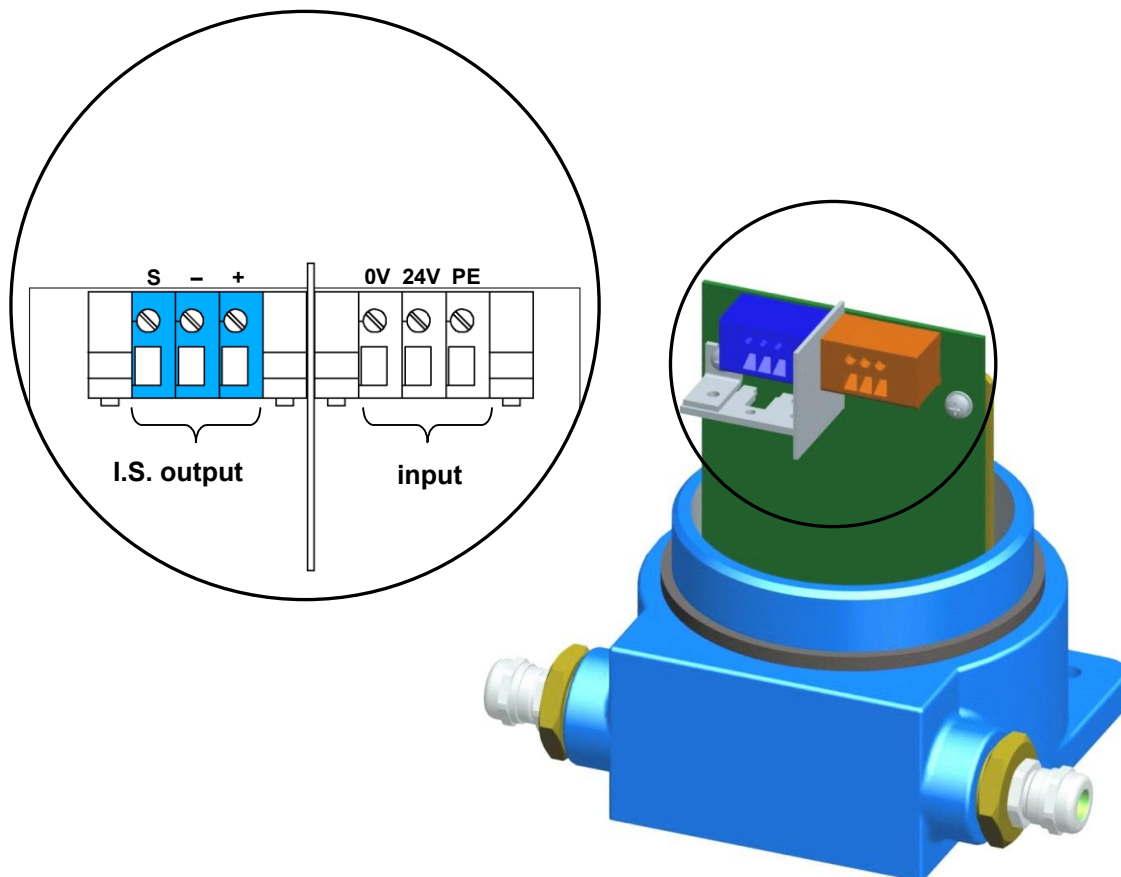



### Wiring the power supply type 1510-101

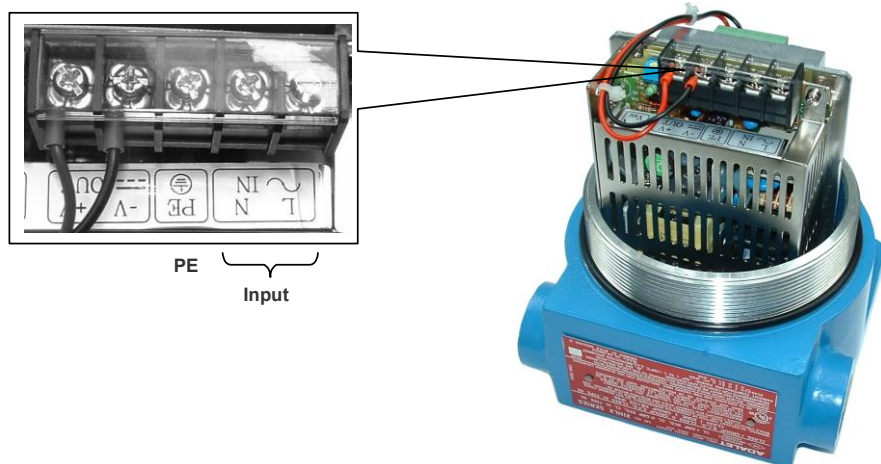

### Wiring:

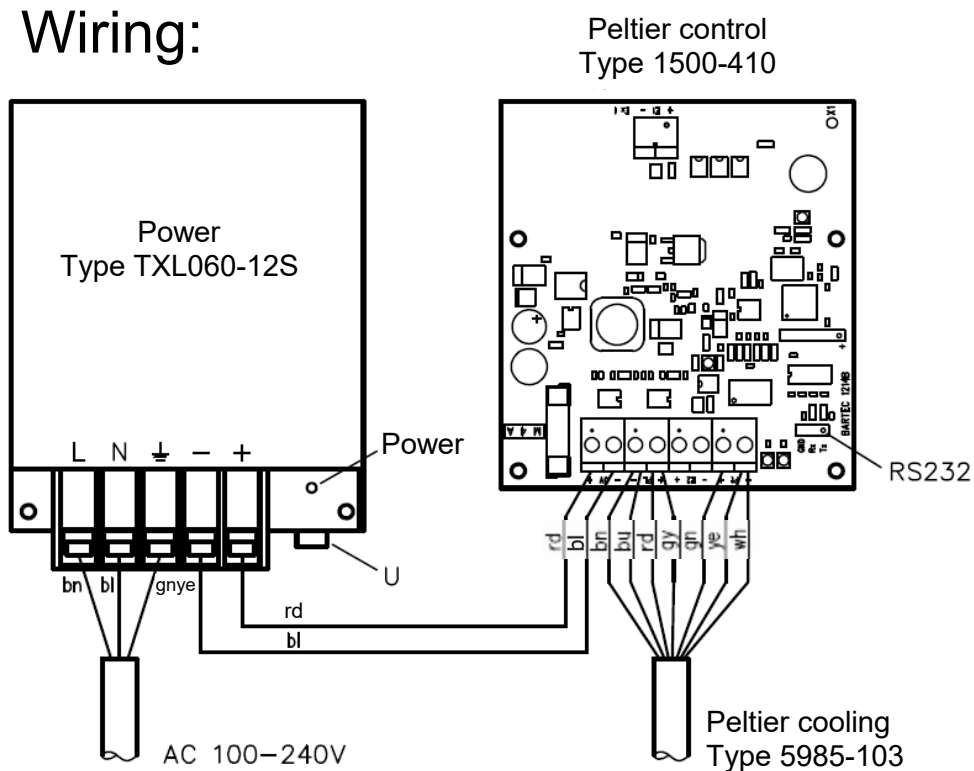

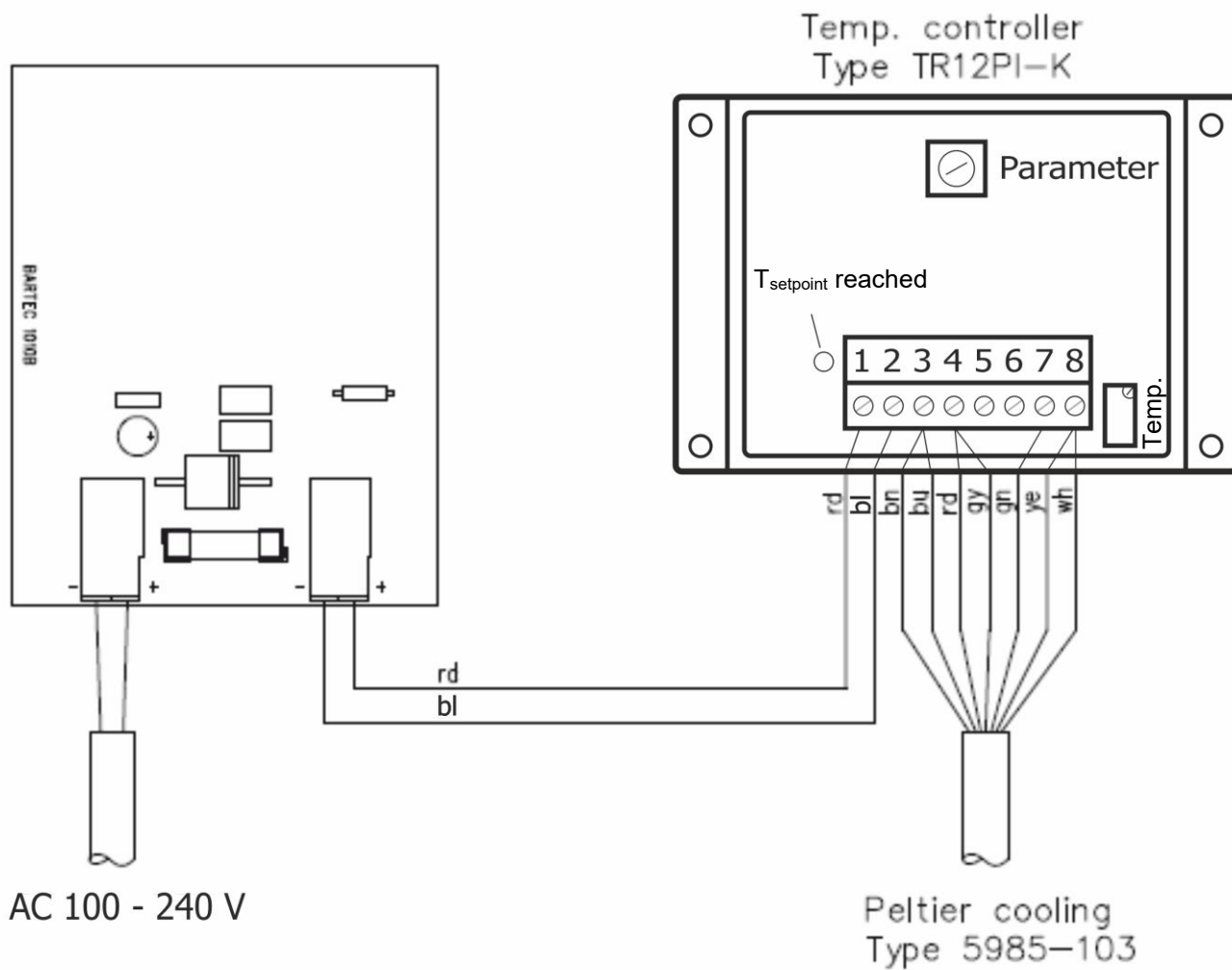

### Power supply wiring (18 to 36V) type 1510-102

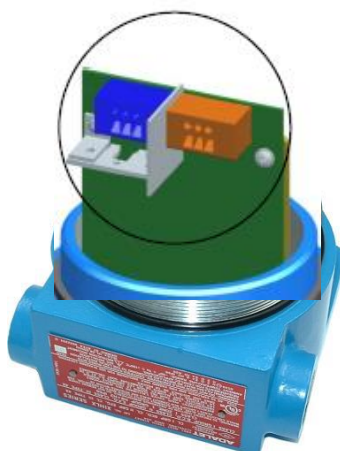

### Wiring:

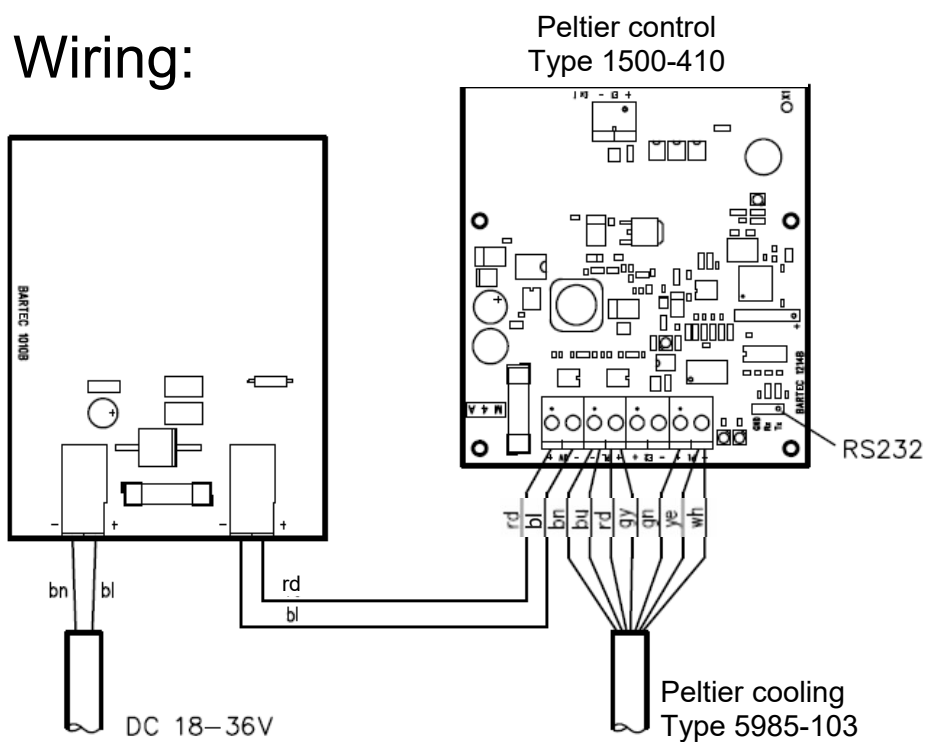

### Power supply wiring (100 to 240V) with shaft temperature tracking type 1510-104

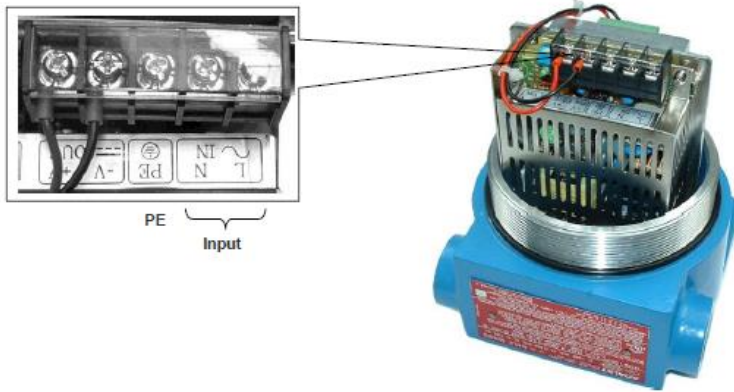

Shaft temperature tracking

Terminal  
SL1:9 (+)  
SL1: 10 (-)

### Wiring:

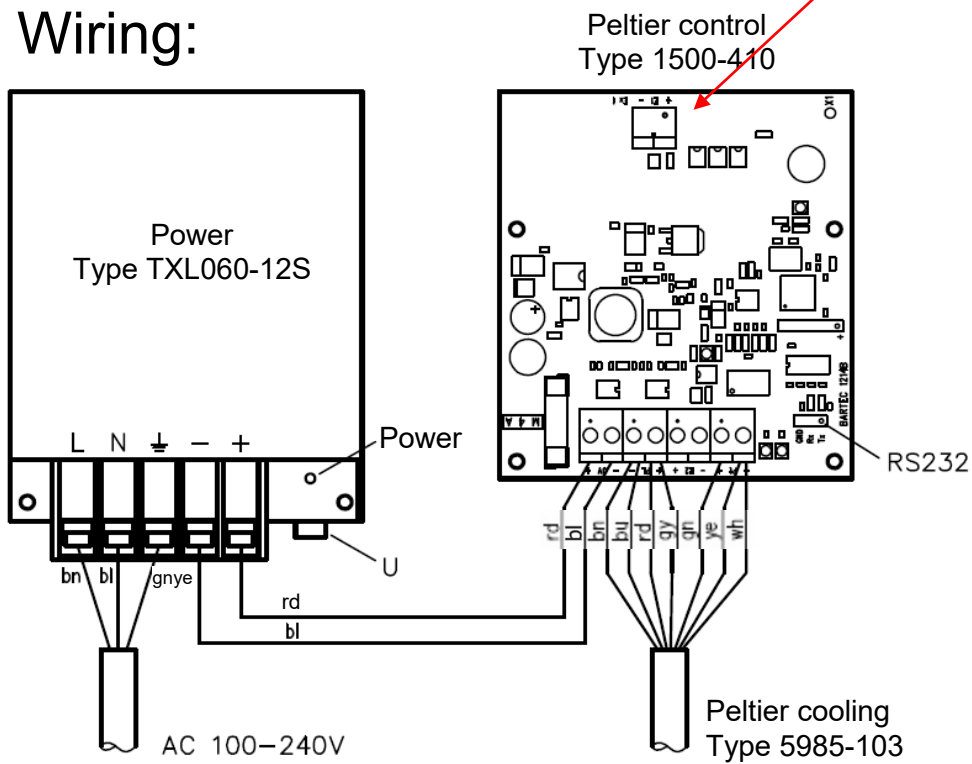

### Power supply wiring (18 to 36V) with shaft temperature tracking type 1510-105

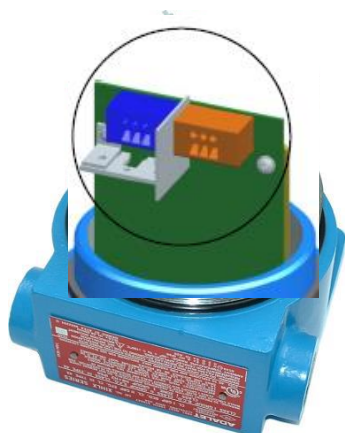

Shaft temperature tracking Terminal  
SL1: 9 (+)  
SL1: 10 (-)

### Wiring:

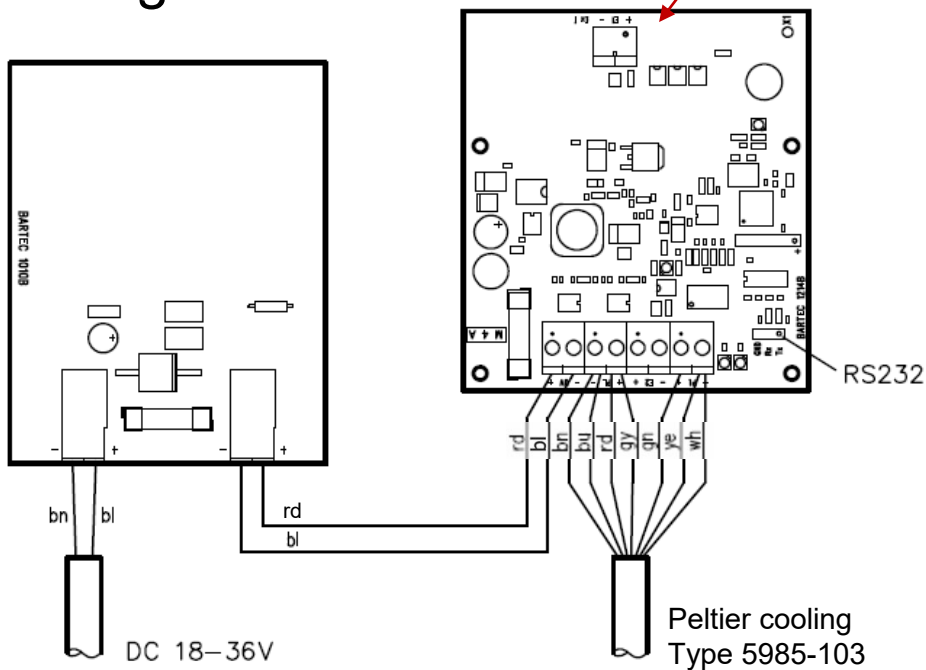

You can find the current wiring diagrams in your customer folder.

### 3.4.3 Connections and initial operation

#### Sample System, 5985

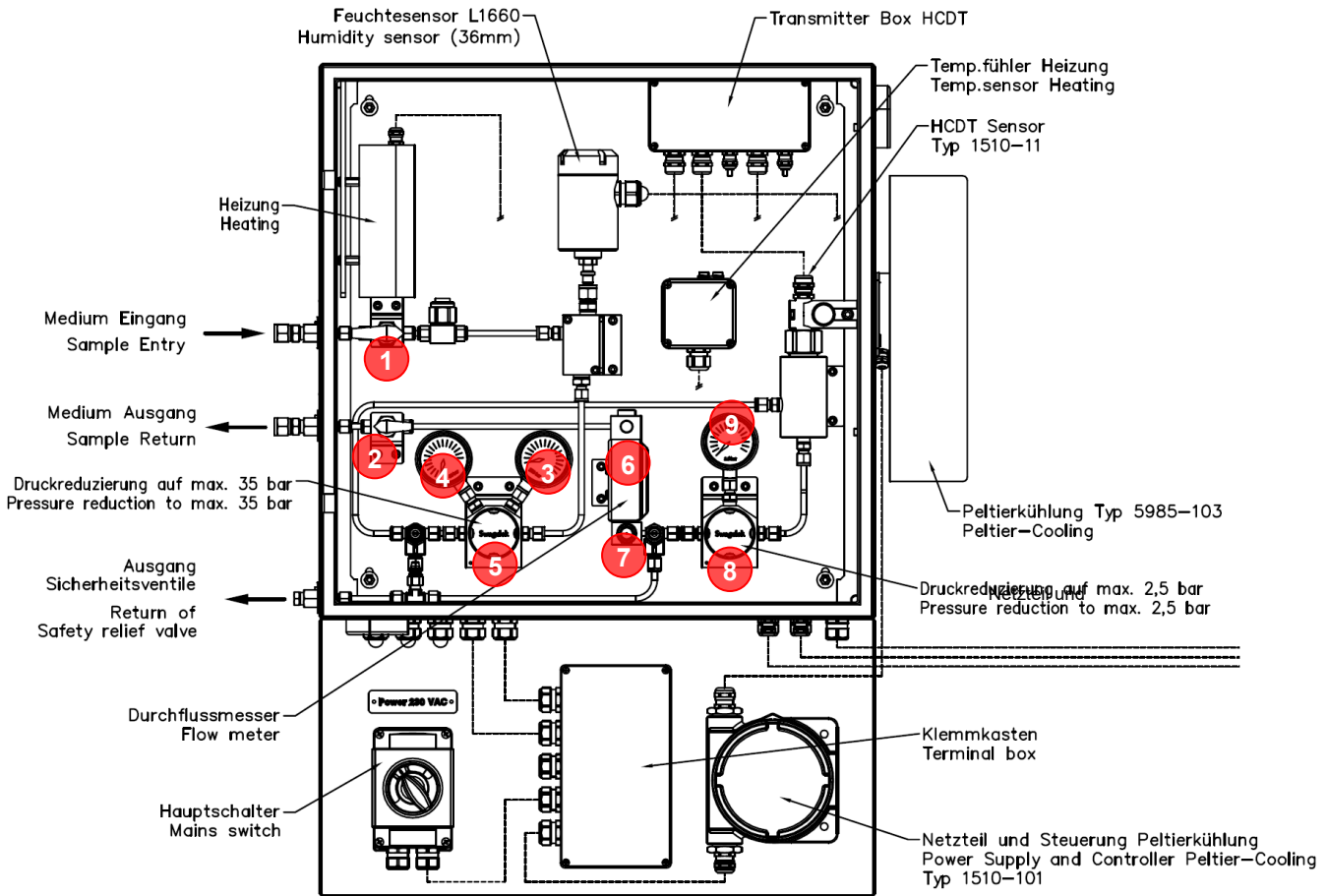

#### 3.4.3.1 Connections

##### Gas

Install supply- and outflow pipe and connect them to the sample system. Sample Entry and Sample Return are prepared for 10 mm Swagelok tube joints. If the pipe diameter differs replace the insets at the connection for matching ones.

At the Sample Return the gas must be outpouring without back pressure.



When installing the system indoors the return of the safety relief valve must also be vented outdoors.

## Electronics

Connect the fibre optic cable with PT100, HCDT data cable and power supply cable according to the wiring diagram at the measuring unit.

### 3.4.3.2

## Settings

### Gas

- Open stop valves at the Sample Entry (1) and Sample Return (2) (turn plug valve into flow direction). You can monitor the inlet pressure at the manometer (3).
- Use the pressure regulator (5) to adjust the pressure to the cricondenherm pressure (4) (20...30 bar).

You can reduce the pressure only when gas is flowing.

Do not increase pressure higher than 35 bar because gas would needlessly be emitted through the safety relief valve.

- Use the pressurestat (8) to adjust the outlet pressure (9) to 1 bar.

You can reduce the pressure only when gas is flowing.

Do not increase pressure higher than 2.5 bar, because gas would needlessly emit through the safety relief valve.

- Use the adjusting valve (7) to adjust the gas flow indicated at the flowmeter (6) to 60...120 liter per minute.

### Peltier-cooling

The Peltier-cooling was optimized in the factory. There is no need of changing any setting by the user.

### 3.4.3.3

## Initial operation

When all connections are complete and all settings are done you can start the measuring device. Connect the power plug to the mains. After 30...40 minutes the HC dew point will be indicated.





# 4 Operation

## 4.1 Start up

The evaluation unit is not equipped with a switch. Connect the evaluation unit to the mains by the mains cable.

After the supply voltage has been applied, the software is initialised. Then the automatic sensor equalisation is carried out („Auto-Equalize“).

This process takes about one minute.

Then the measuring variables are displayed. HCDT is displayed after some minutes delay.

## 4.2 Automatic sensor equalizing

The automatic sensor equalizing as it is executed when the system is started, will be repeated in an interval of 24 hours, when a measuring cycle is finished.

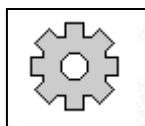

You can trigger the sensor equalizing any time during the measuring mode. Touch **F1** or **F2** key. The current functions of these keys are displayed. Then touch **F1** key, to start the automatic sensor equalizing function.

CH	ExTime	I-LED	% Int
1	36	15	65
2	---	---	---
3	---	---	---

## 4.3 Display modes

After the automatic sensor adjustment has been completed, the unit is ready for operation.

The display can take place in three different online modes and one history graphic mode.

Use  $\triangle$  and  $\nabla$  to switch between the three online display modes.

Use  $F2$  to switch between the online graphic display and the history graphic display (see page 4-12).

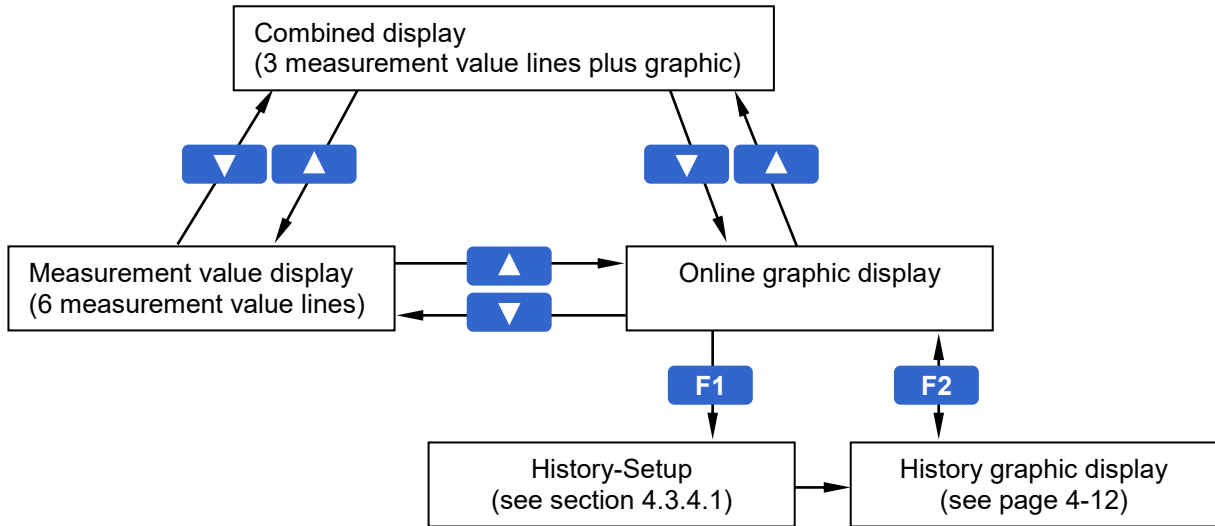

## 4.3.1 Combined display

The display shows three lines which can indicate different measurement variables at the same time.

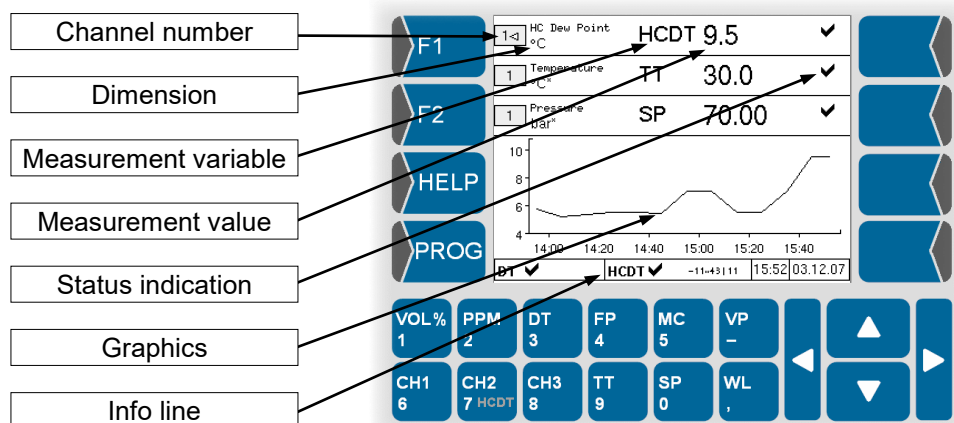

You can assign to each line a measurement variable to be displayed.

### 4.3.1.1 Selecting a line

Before you can set the indication of a line, you have to select this line. Touch the field which indicates the channel number.

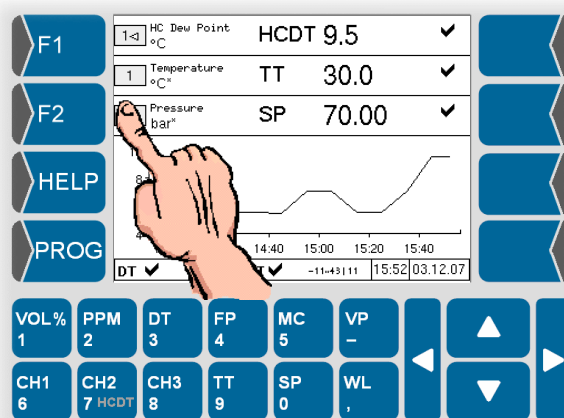

When the line has been selected, it is marked by an arrowhead after the channel number.

### 4.3.1.2 Assigning a measurement variable

In order to assign the measurement variable to be displayed to the selected line, touch the key with the appropriate measurement variable.

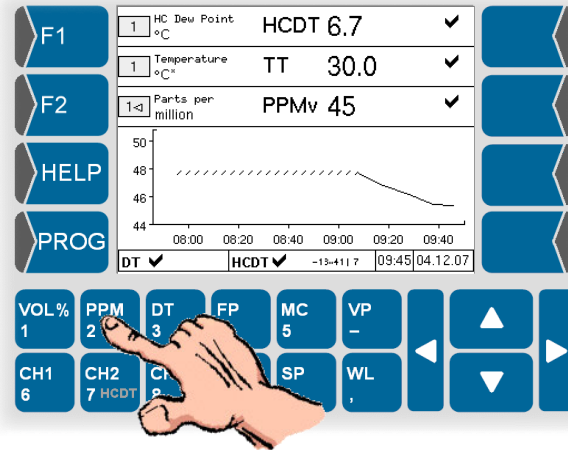

The selected measurement variable is indicated.

With the key for vapour content [Vol%], you can toggle the display between vapour content and relative humidity.

### 4.3.1.3 Fixed values

If a primary measurement variable is not measured by a sensor, the fixed value configured for it is displayed (see section 5.6.4). In this case, an asterisk is displayed behind the dimension.

### 4.3.1.4 Status indication

In each line, the status of the measurement values is indicated by icons.

Icon	Meaning
✓	Measured values are ok
↑ VOL	Programmed limit (see section 5.6.5) has been exceeded. Below the icon there is the measurement variable whose limit has been exceeded (see also section 6.1).
↓ VOL	Programmed limit (see section 5.6.5) has been fallen below. Below the icon there is the measurement variable whose limit has been fallen below (see also section 6.1).
⊘	Error Indication of an error, measuring mode is not possible any more (see also section 6.3)

### 4.3.1.5 Graphic

Below the indication of the measurement variable there is a diagram presenting the measurement value curve of the measurement variable in the currently activated line for the last two hours.

If you activate another line, the graphic for the measurement values of this line is displayed. In intervals of 30 seconds, another measurement value is displayed. Every 10 minutes a measurement value is written into the data memory. If you switch to another display and then return to the graphic display, the recorded data is read from the data memory and is presented. Due to the data recording in intervals of 10 minutes, the curve is smoothed.

For periods during which no measurement values are available (e.g. device is turned off, no sensor is connected), the measurement value progress curve is hatched.

### 4.3.1.6 Info line

The info line below the graphic shows information on the operating status of the measuring channel, the current working temperature range and as well as the current date and time.

Icon	Meaning
✓	Measured values are ok
↑ VOL	Programmed limit (see section 5.6.5) has been exceeded. Below the icon there is the measurement variable whose limit has been exceeded.
↓ VOL	Programmed limit (see section 5.6.5) has been fallen below. Below the icon there is the measurement variable whose limit has been fallen below.
⚠	Warning Indication of missing measurement values, fixed value is used. The measuring operation is not interrupted (see also section 6.2)
⊘	Error Indication of an error, measuring mode is not possible any more (see also section 6.3)

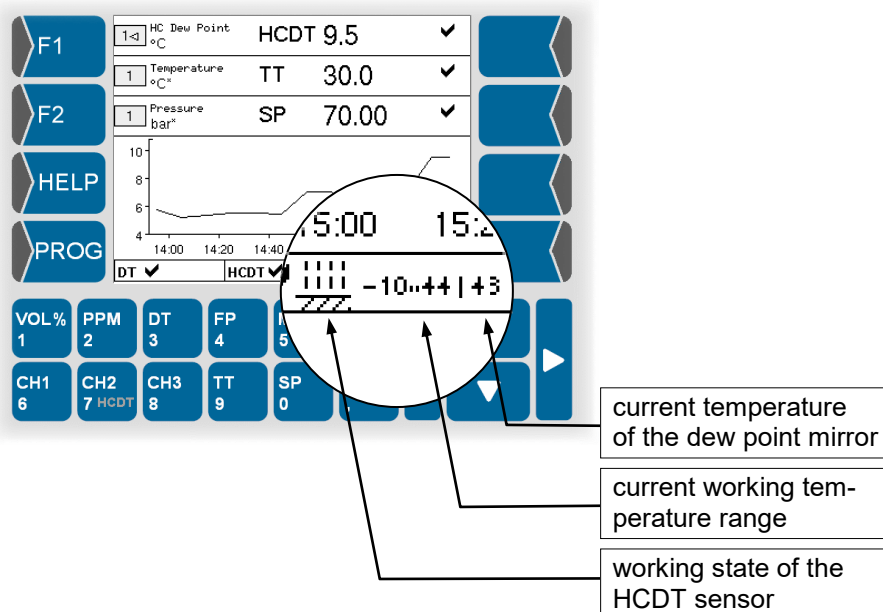

Working state of the HCDT-sensor	
Icon	Meaning
 zzz	Heating up
 zzz	Fast going to the last detected hydrocarbon dew point temperature
 zzz	Seeking the current dew point temperature

## 4.3.2 Measurement value display with six lines

In this display mode, three further lines with measurement value indications are shown instead of the graphic.

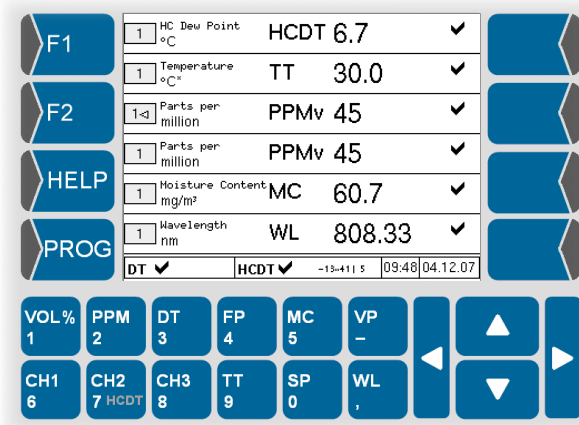

The setting of the display in the six measurement value lines is the same as in the combined display modes. Any changes of the settings in the first three lines are taken over into the mixed display mode after switching there. The status display and the info line are the same as in the combined display mode.

## 4.3.3 Online graphic display

In the online graphic display, the measurement value curve of the measurement variables of line 1, 2 and 3 for the last 2 hours is presented.

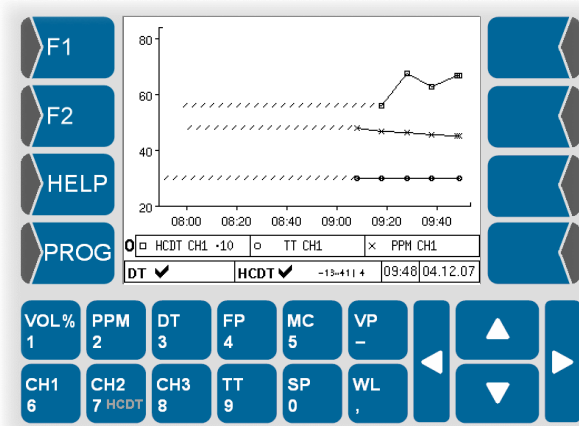

To distinguish the curves, they are marked with different symbols (x, □, ○).

As only one scaling is used for the measurement value axis, the measurement values are multiplied by powers of ten so that they can be presented within the value range of the measurement value scale.

In the line below the graphic, you find some information on the three measurement value curves presented. The “O” at the beginning of this line stands for “Online” and serves to distinguish this mode from the “History graphic mode” („H”).

Every 30 seconds a new measurement value is presented.. Every 10 minutes, a measurement value is written into the data memory. If you switch to another display and then return to the graphic display, the recorded data is read from the data memory and is presented. Due to the data recording in intervals of 10 minutes, the curve is smoothed.

For periods during which no measurement values are available (e.g. device is turned off, no sensor is connected), the measurement value progress curve is hatched.

The info line is presented like in the two other online display modes.

## 4.3.4 History graphic display

The measurement values recorded in intervals of 10 minutes are written into a database with a memory capacity for 6 months.

You can define a period for which you want to present the stored measurement value progress curves for up to three measurement categories.

### 4.3.4.1 History Setup

- Switch to the online graphic mode.
- Touch **F1** or **F2** key. The current functions of these keys are displayed.

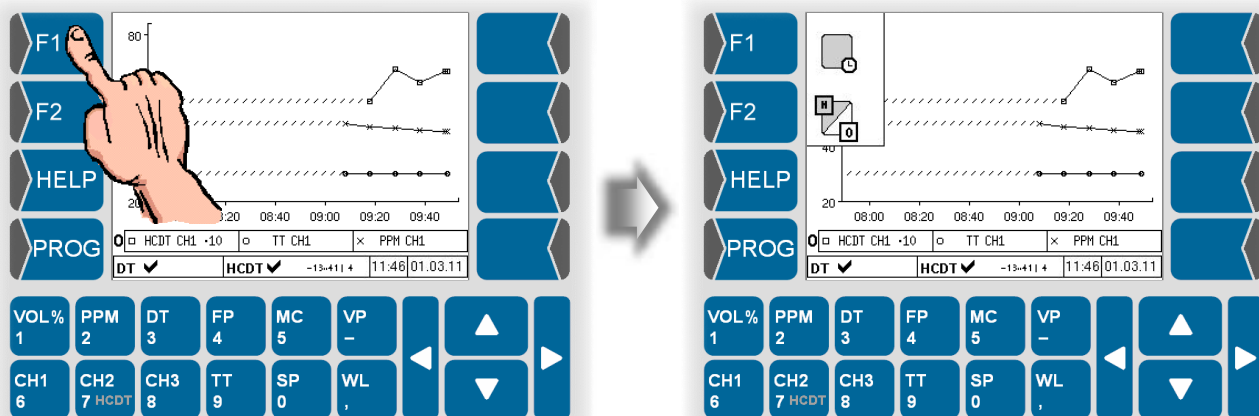

- Then touch the **F1** key to open the History Setup.

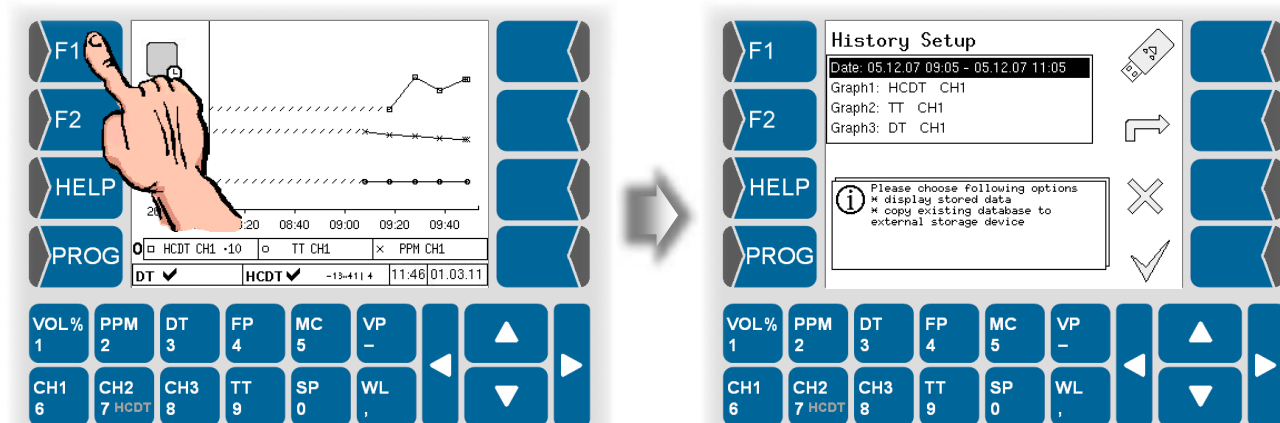

### Defining the presentation period

- Open the dialog for editing the presentation period (date)

You can see the period containing data in the database in the display. The point in time of the first and last value for the channel is displayed.

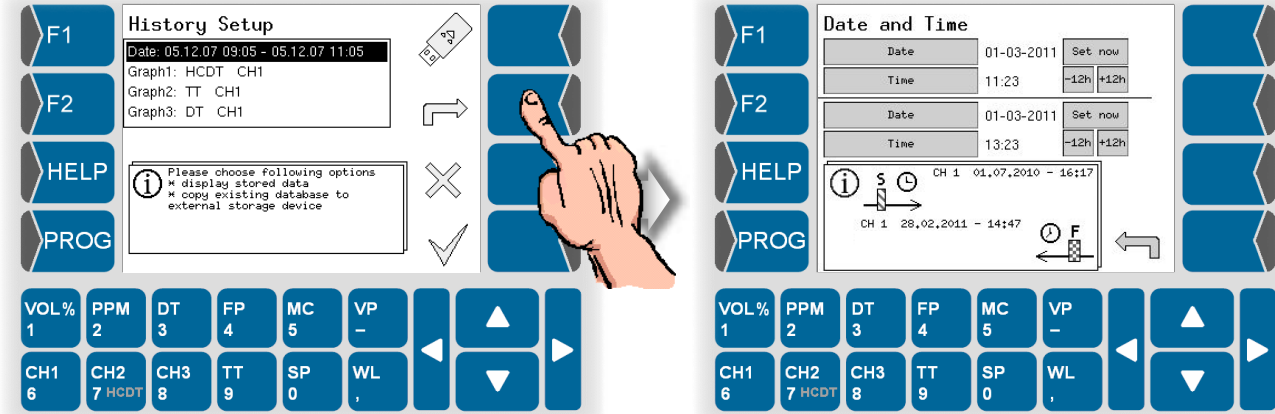

Now you can define the presentation period.

- Touch **Date** and **Time** for the start and the end of the presentation period and enter the required values.



Use this button to set the current time and date.

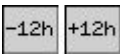

Use this buttons to change the time in 12 hour steps.

You can enter each other time and date into the according field.

The time between the start and the end of the presentation period has to be at least 2 hours.

- Touch  to confirm the entries.

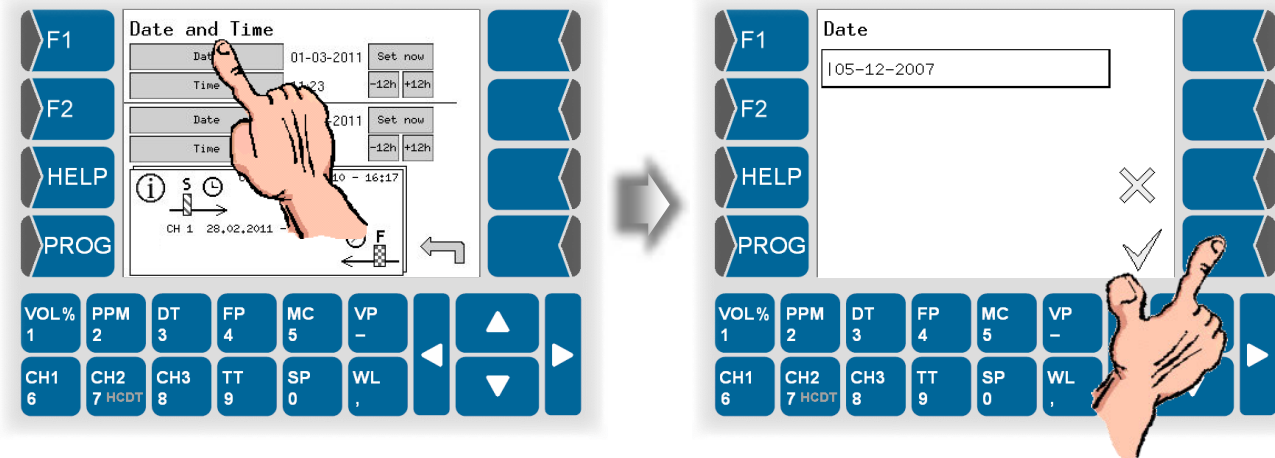



If the presentation period you have defined is too short, a message appears when you leave the history setup.

If you confirm the message by pressing , the period of 2 hours is automatically selected.

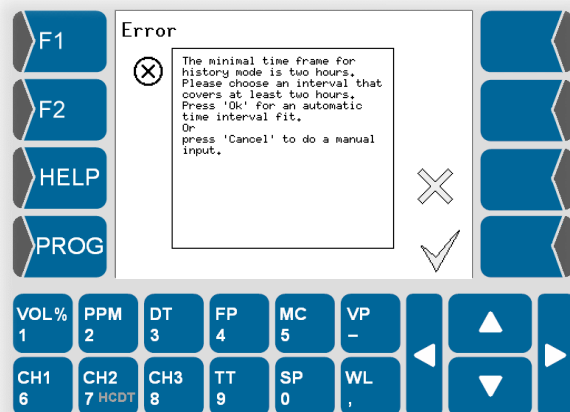

If the selected presentation period includes a period for which no data is available, the following message appears.

If you confirm the message by pressing , the period is automatically corrected.

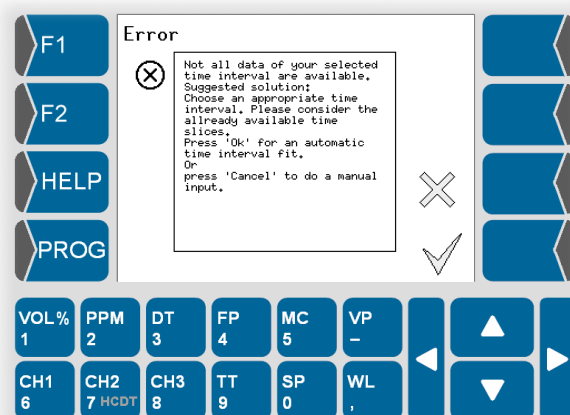

### Defining the presentation of the graph

- Select a line for the graph (graph 1 in the example below) and open the dialog for editing the graph.

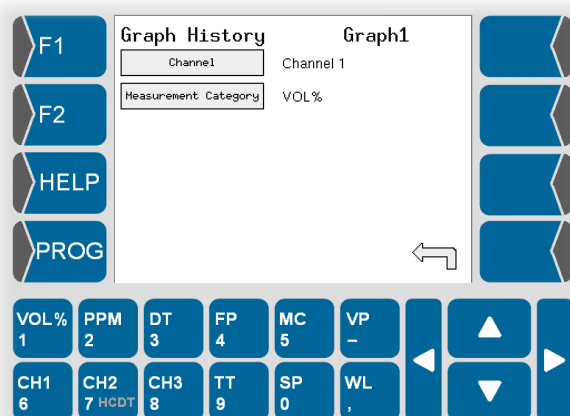
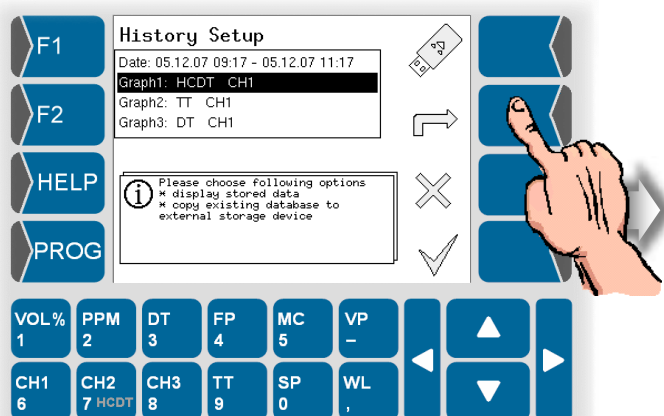

Now you can define the measurement variable for the selected graph.

- You need not select a channel. The version of the measuring device with HCDT-measuring uses only one channel. Open the Measurement category selection.

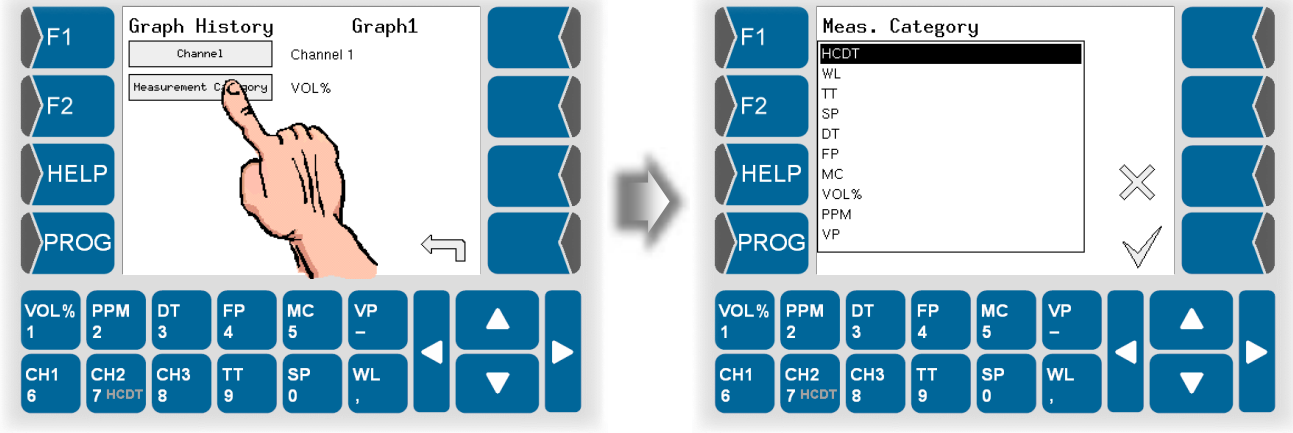

- Use  and  to select the measurement variable whose measurement value curve shall be defined for the defined period. Use  to confirm the selection.

In the same way you can define two further measurement variables whose measurement curve shall be presented for the defined period (graph 2, graph 3).

### 4.3.4.2 Display the history graphic

- After carrying out all required settings for the graphic history mode, touch .

If the settings are incorrect, a message will appear (see page 4-9).

If the settings are correct, the history graphic is displayed.

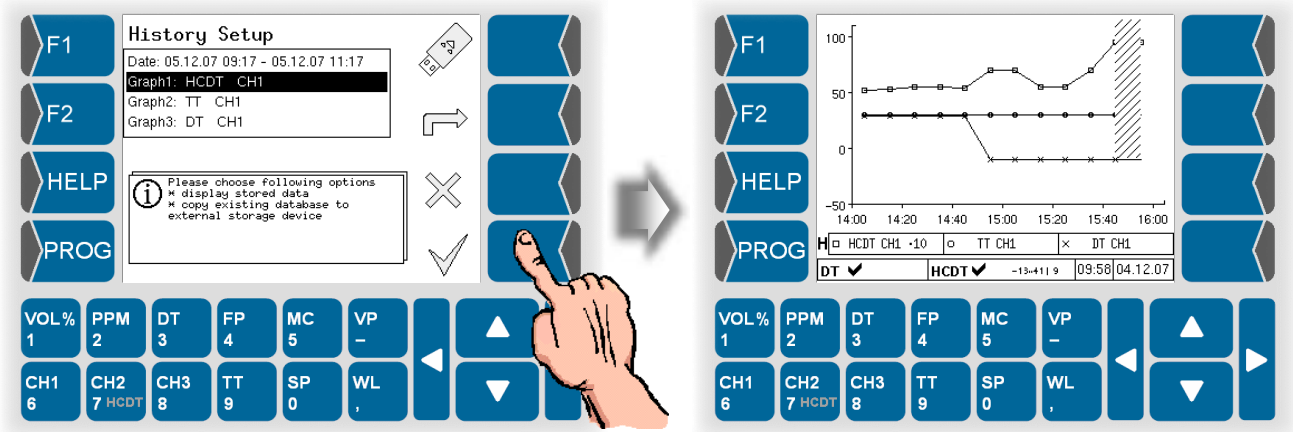

Like in the online graphic mode, the curves are marked with different symbols (x, □, ○). As only one scaling is used for the measurement value axis, the measurement values are multiplied by powers of ten so that they can be presented within the value range of the measurement value scale.

In the line below the graphic, there is information on the three measurement value curves presented. The letter “H” at the beginning of this line stands for „History“ and serves to distinguish this mode from the “Online graphic mode” (“O”).

### Hide Graphs

By touching the three upper keys right of the display you can hide and recall each of the graphs.

- Touch one of the keys right of the display. The current functions of these keys are displayed.
- Touch the according key to hide or to display one of the graphs.

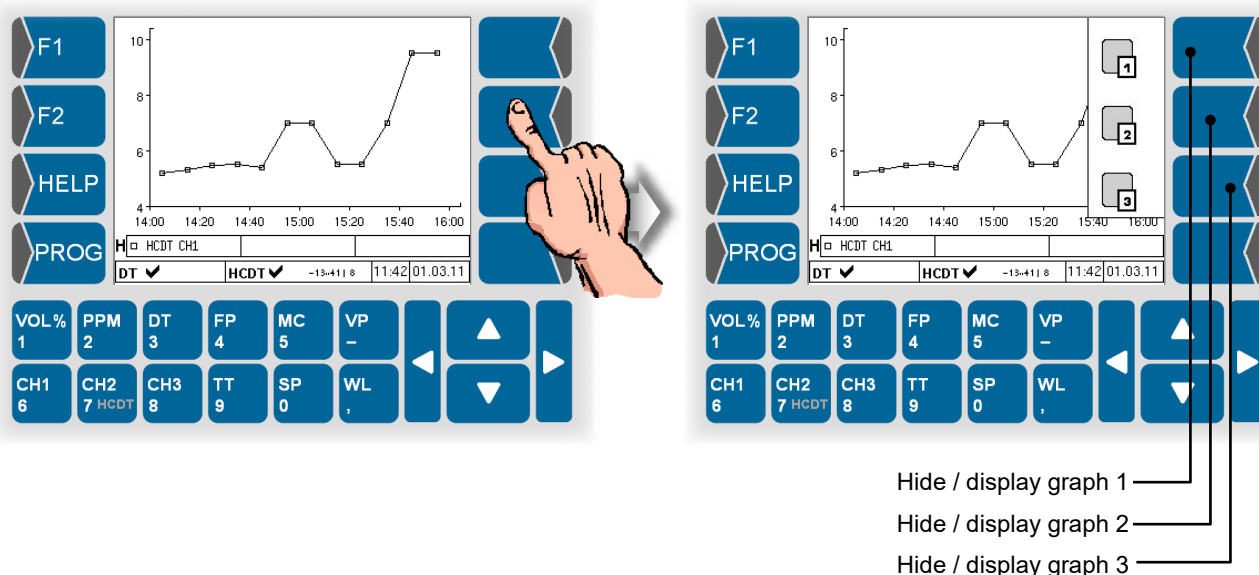

### Changing the display mode

Use **F2** to switch between the history graphic mode and the online graphic mode.

- Touch **F1** or **F2** key. The current functions of these keys are displayed.

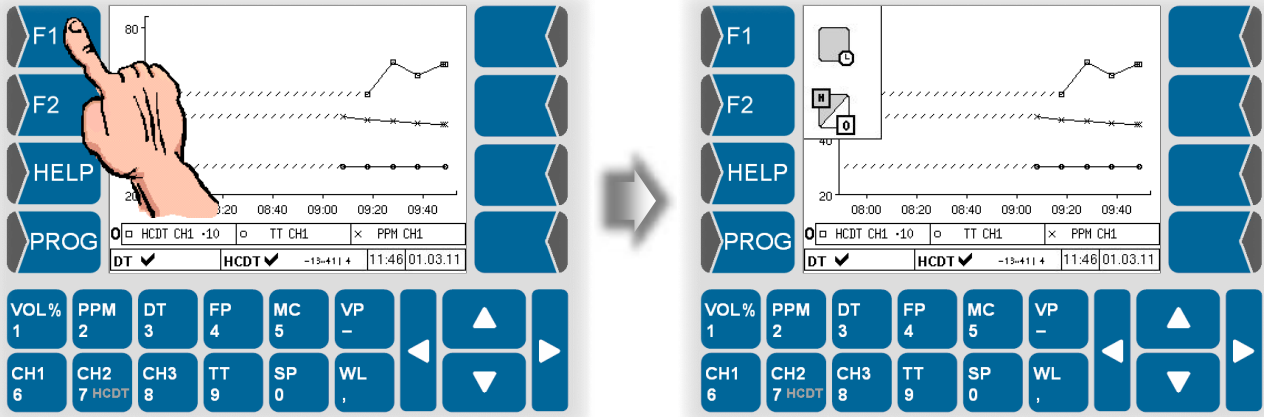

- Then touch **F2** key, to switch from online graphic mode to history graphic mode or reverse.

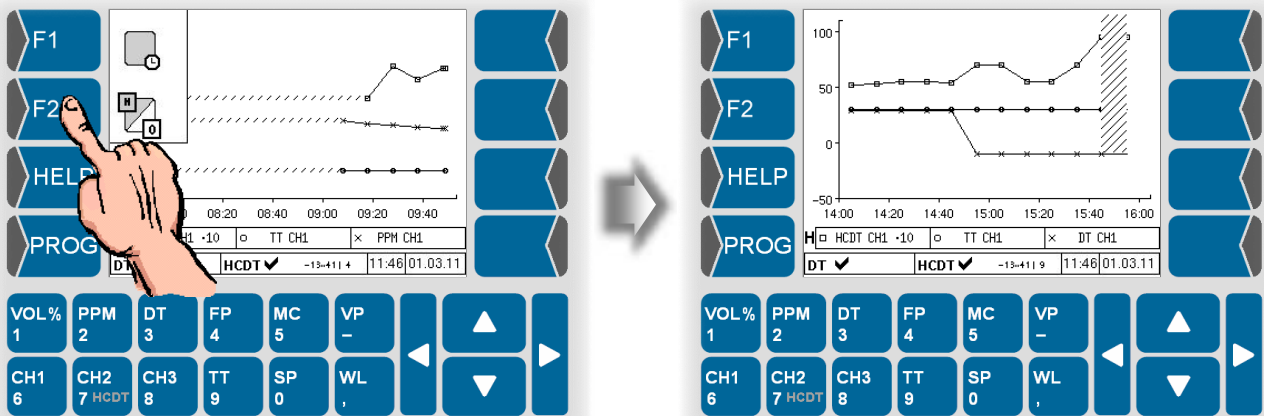

Use **△** and **▽** to leave the history graphic mode and switch to an online indication mode.  
 To call up the history graphic mode again, switch to the online graphic mode and then touch **F2** twice.

## 4.4 Data export

HYGROPHIL® F 5673 saves the measuring data in a SQLite-database. You can copy this database via USB-port to an external data medium and if required convert into a .csv file.

### 4.4.1 Copy data

- Connect the external medium (e.g. USB-stick) to the USB-port at the back of the evaluation unit.

The data medium must be FAT 32 formatted!

- Call up History-Setup (see section 4.3.4.1).
- Touch the key with the USB-stick icon.

Then you can choose to transfer a PC software (data converting program) additionally. For using the data converting program, you must only transfer it once.

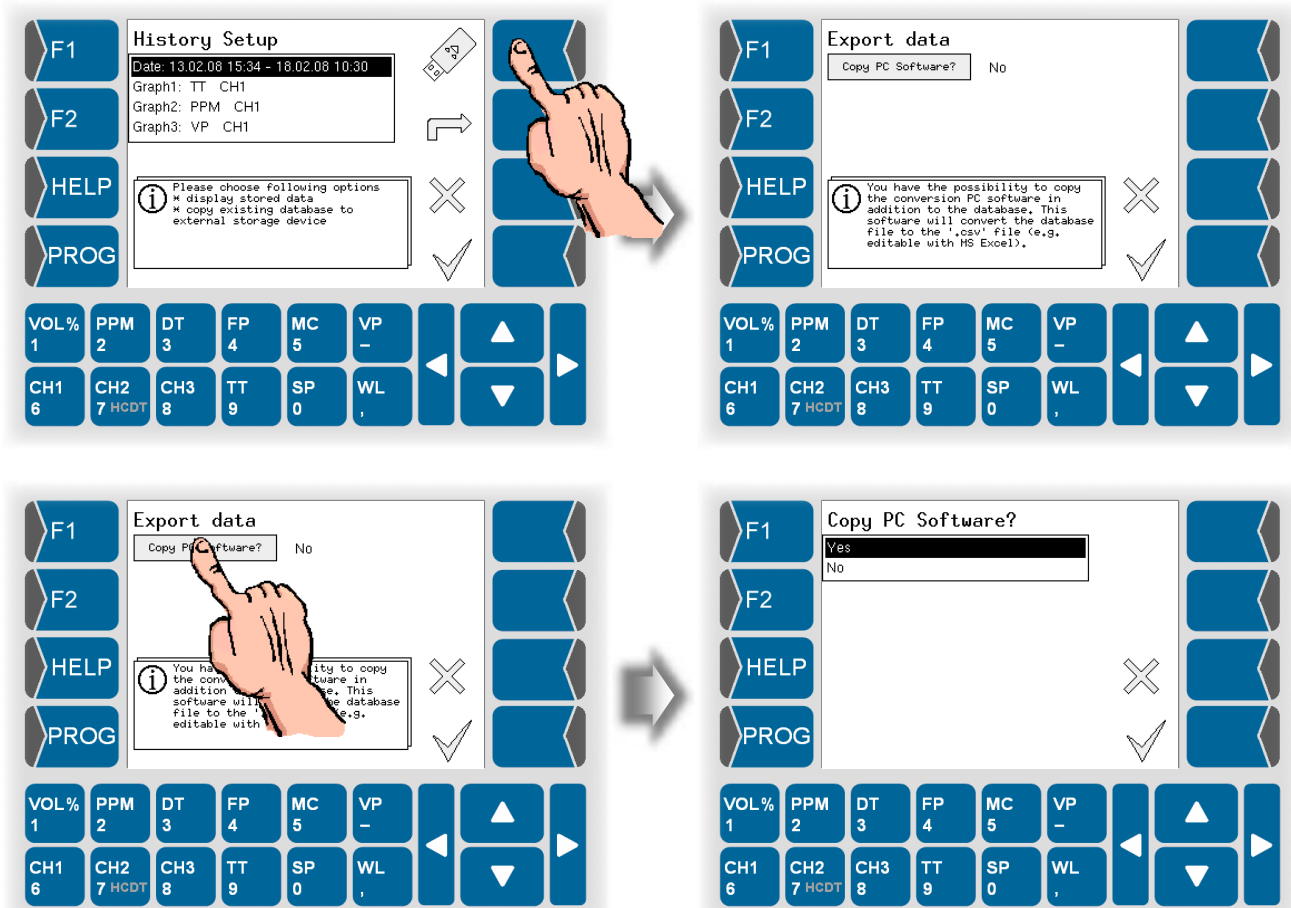

- Start data export with the  key.

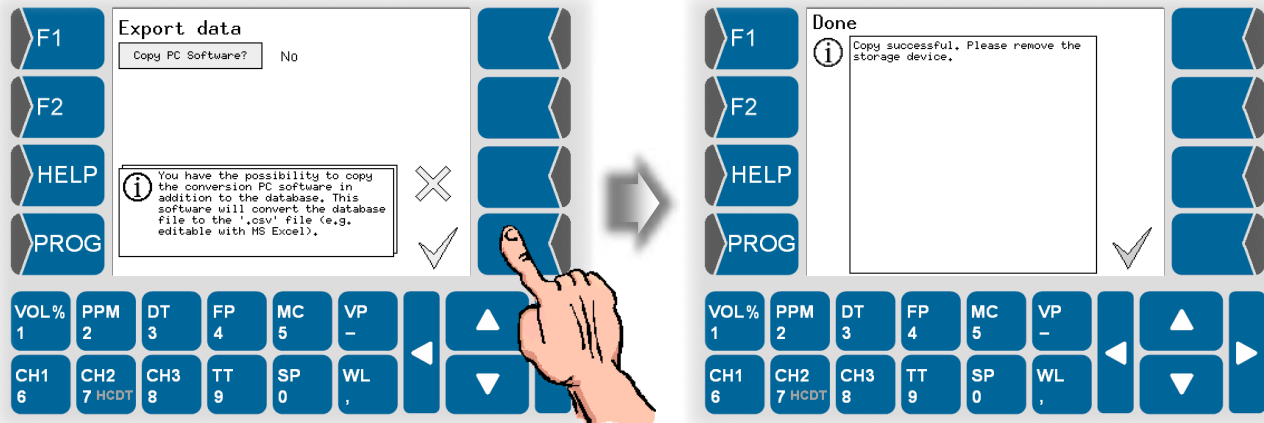

The database is always transferred completely. The defined presentation period for the history graphic display has no influence on the data export.

- For further processing the data connect the data medium to your PC via USB-Port.

## 4.4.2 Converting data

By using the PC-program that you can transfer additionally to the database you can convert the database to a .csv file. You can open and edit this file in Windows-applications, such as MS Excel, Open Office.

- First unpack the file *hygrodb2csv\_win.zip*. It contains the converting program.
- The folder *hygrodb2csv\_win* contains the program file *hygrodb2csv\_win.exe*. Start this program.

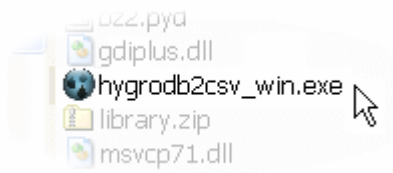

- Choose in the line below „Input Path“ the file that is to convert.
- Choose in the line below „Output Path“ the folder in which the converted data shall be saved. Instead of the file name „output“ you can enter a desired file name.
- Under „Units“ select the output format of the measuring values.
- Under „Decimals format“ select the kind of decimal separator.
- Start converting with the **Convert** button.

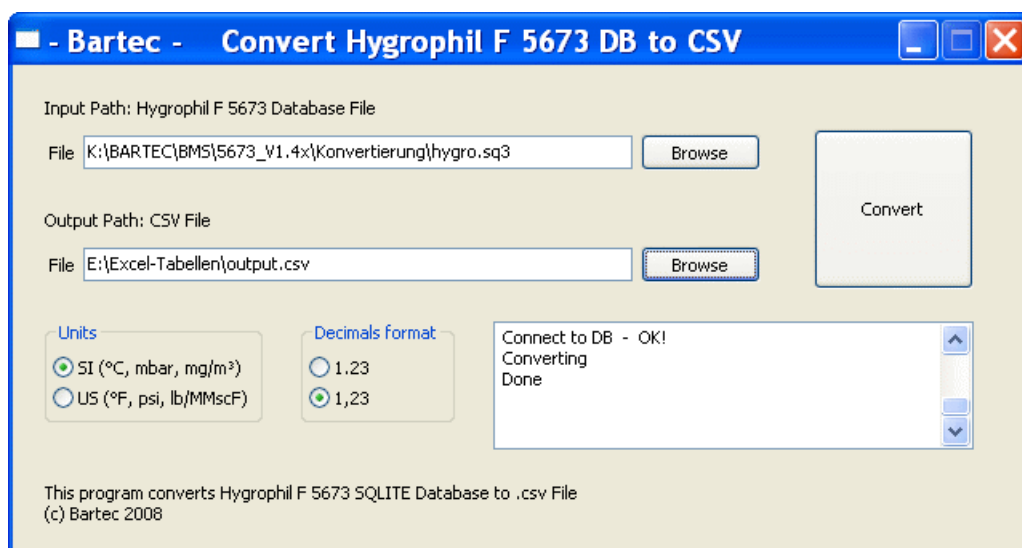

### 4.4.3 Export service information to an external data medium

For an analysis by your service staff you can export service information to an external data medium. Databases, log files and configuring information will be copied to the data medium. For this purpose open the menu „System Information“ (see section 5.6.14).





# 5 Programming

Various operating parameters and functions can be programmed in order to operate the HYGROPHIL® F 5673 humidity measurement system. You can adjust the measurement system to the given operating requirements and the system environment.

An overview of the menu structure in the programming mode can be found in section 5-6.





## 5.1 General instructions

In the programming mode, the humidity measurement goes on in the background.  
After the return to the display mode, the indication is updated in accordance with the new programming.

The following sections describe the principles of working with the different menus and the parameter settings.

The keys can be assigned different functions whose current meaning is marked by icons.

All keys are touch-sensitive, i.e. you need not press them but only touch them.

Icon	Meaning	Effect
	Open	The marked menu is opened, for a marked parameter, an entry dialog or a selection dialog is opened.
	Quit menu	You quit the menu that is open at present and change over to the super ordinate menu.
	Abort	You quit the menu that is open at present and change over to the super ordinate menu. Settings/entries already carried out are rejected.
	Correct	In an entry dialog the character left to the cursor is deleted.
	Take over, store	The selected setting of a parameter is confirmed. You quit the menu that is open at present. All settings/entries (also of the subordinate menus) are taken over and stored. <b>All changes will only be stored if you quit the menu by means of this key!</b>

## 5.2 Calling up programming mode

- Touch the **PROG** key to call up the programming mode.

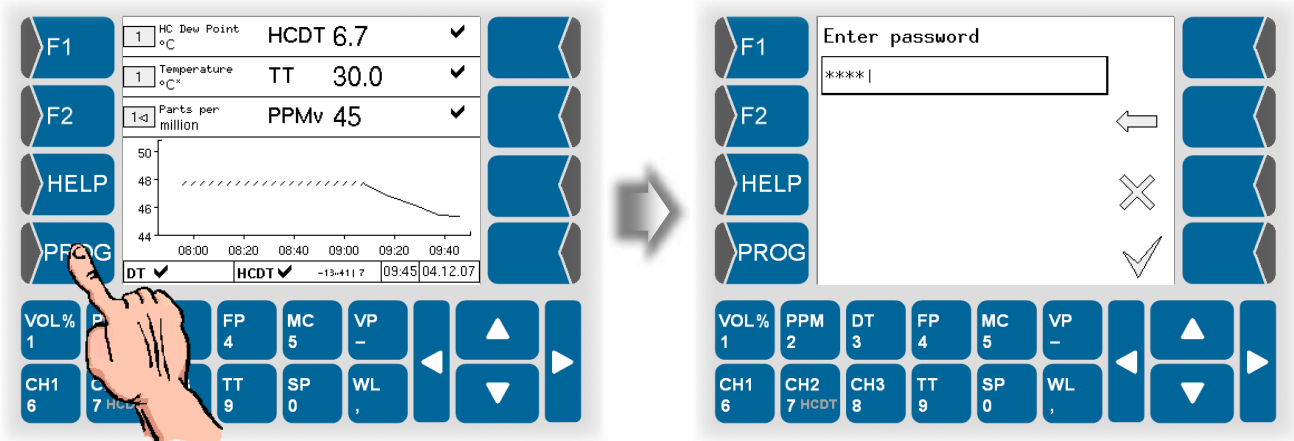

Then you must enter the password. The default password is 5673. You can change the password (see section 5.6.15).

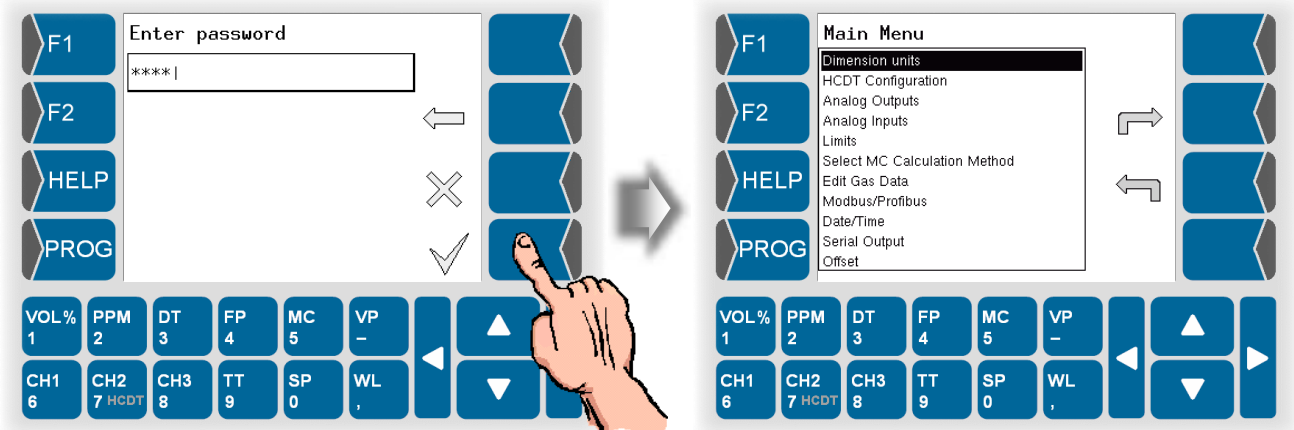

- Enter the valid password and confirm it. The main menu will be opened.



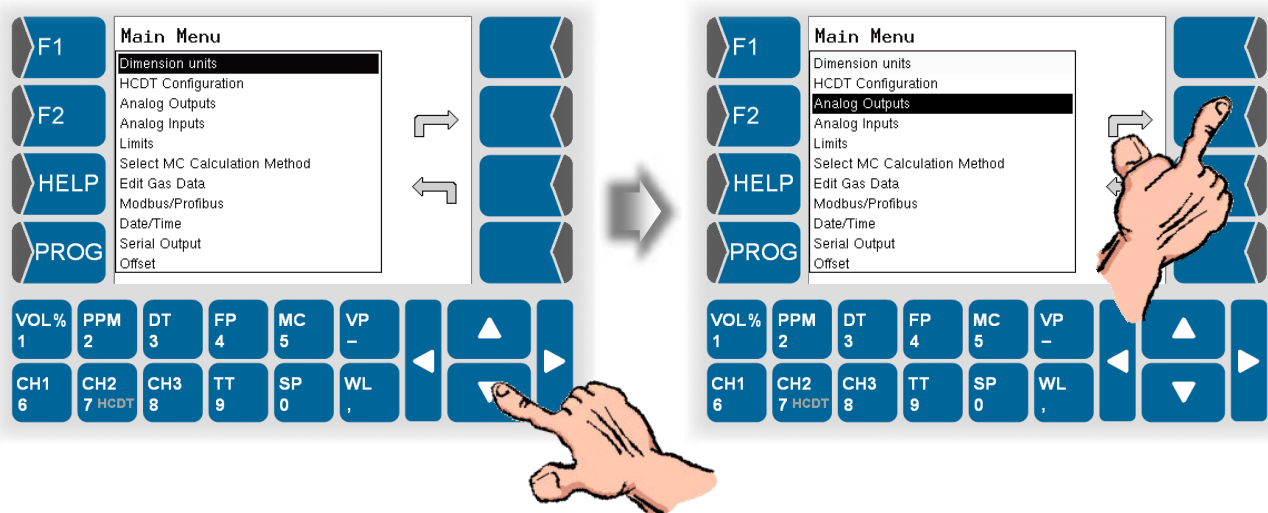

## 5.3 Selecting and opening the menu

- Use  and  to select the menu to be opened.
- Then touch the open-key .



You can open some menus only after having selected a system component (channel board, analogue output).

Touch  and  to select a system component and then touch  to open the menu.

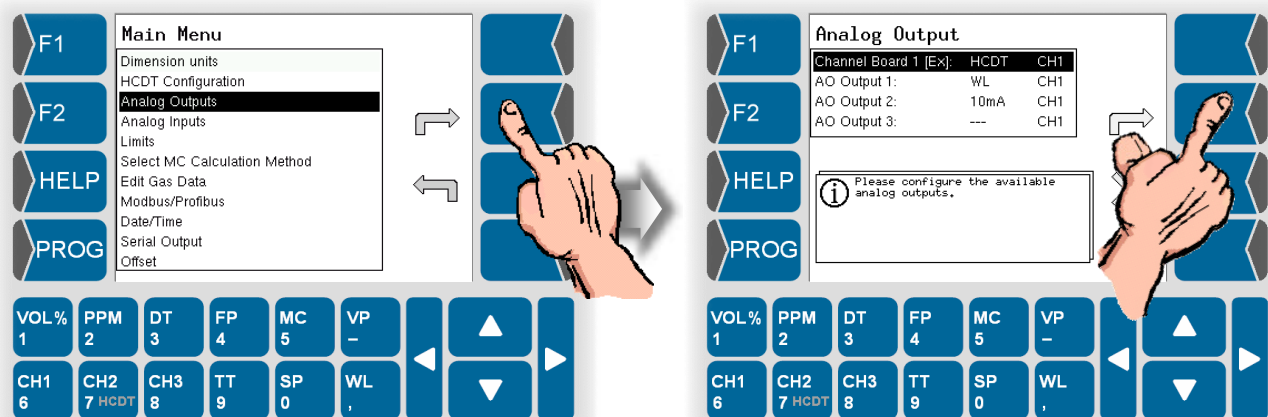

## 5.4 Editing parameters

- On the display, touch the field whose parameters you want to edit.

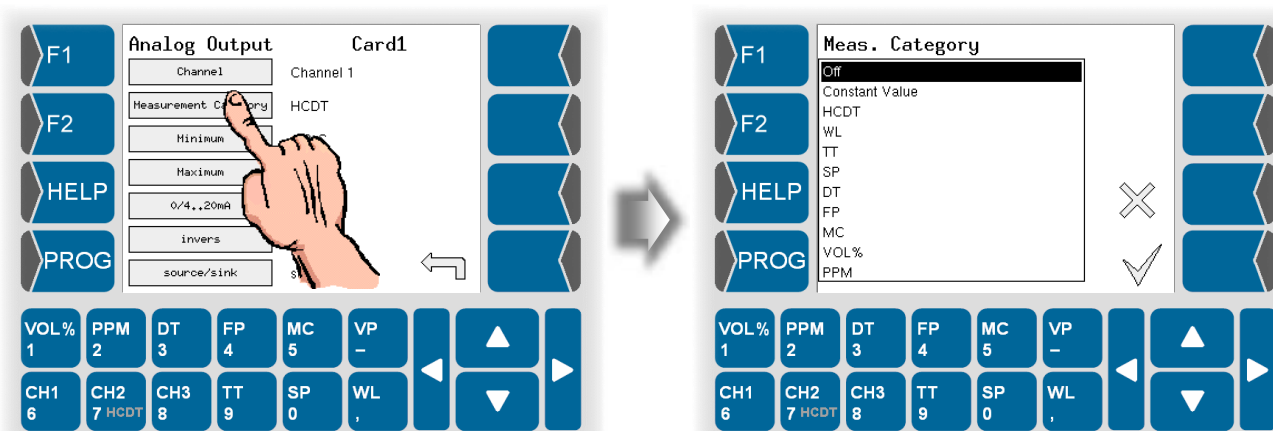

### 5.4.1 Selecting the parameter setting

- Use  and  to select the required setting, then confirm the selection.

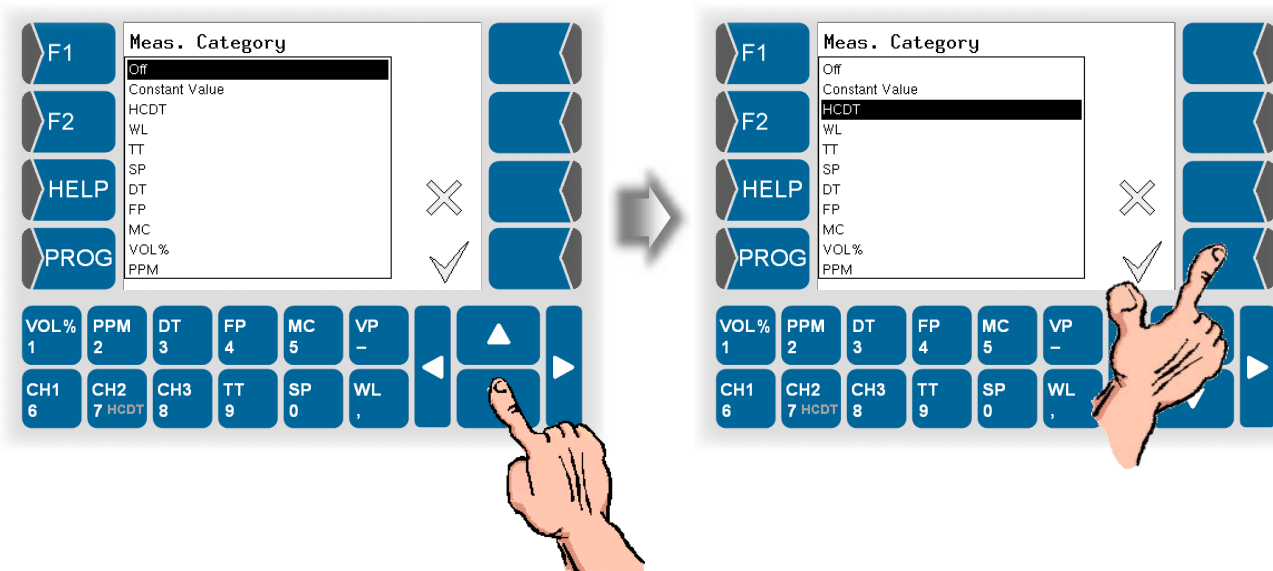

The change is not saved in the program memory until you also leave the super ordinate menu by using .

## 5.4.2 Selecting the parameters for editing

If the menu contains several parameters which can be edited individually, first select the parameter and then touch  to open the appropriate editing dialog.

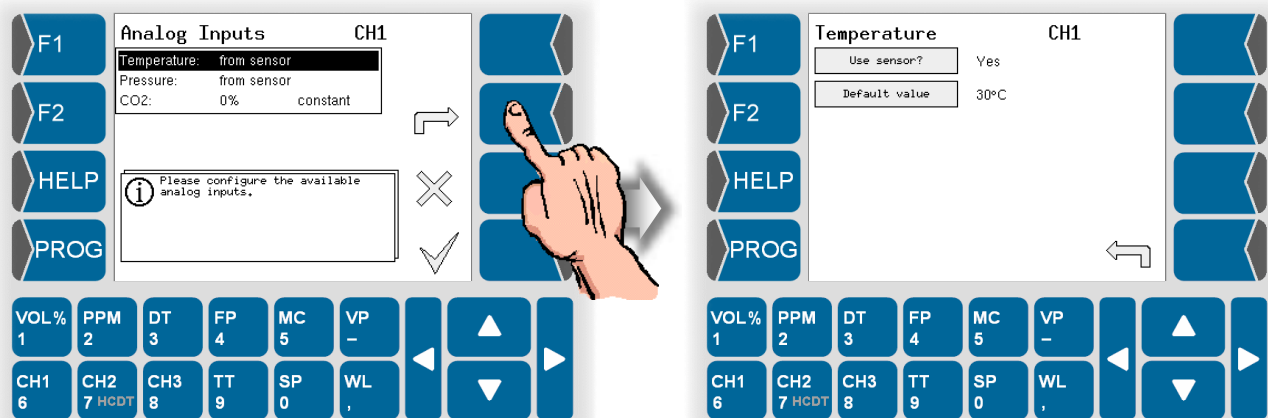



Now you can edit the settings of this parameter.

Either a selection dialog (see section 5.4.1) or an entry dialog for the entry of numerical values (see section 5.4.3) is opened.

## 5.4.3 Numerical entries

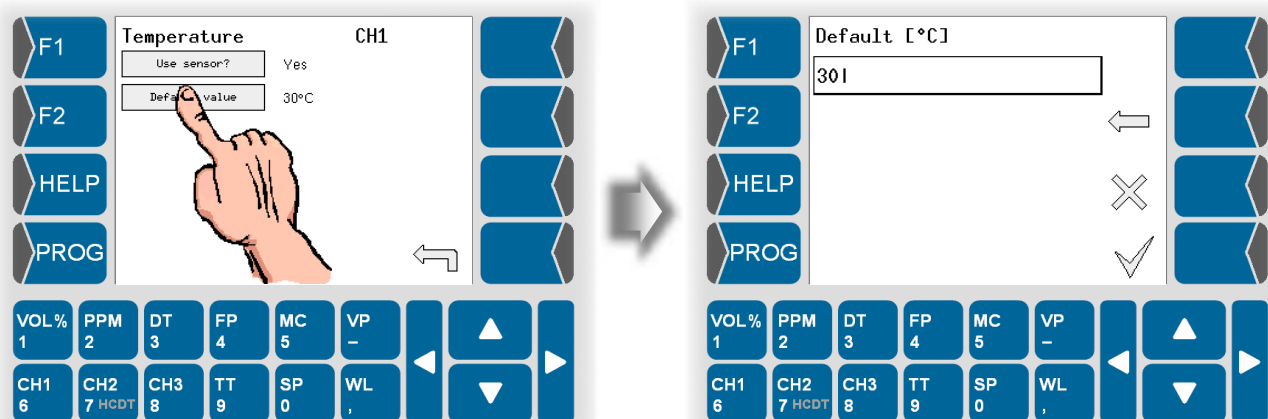
You can enter numerical values by means of the keys below the display. The value that was set up to now is displayed after opening the dialog.



Use  and  to change the position of the cursor.

The delete key (arrow pointing to the left) is available for carrying out corrections. If you touch this key, the character left to the cursor is deleted.

Touch the OK key to confirm the entry.

## 5.5 Structure of the programming menu

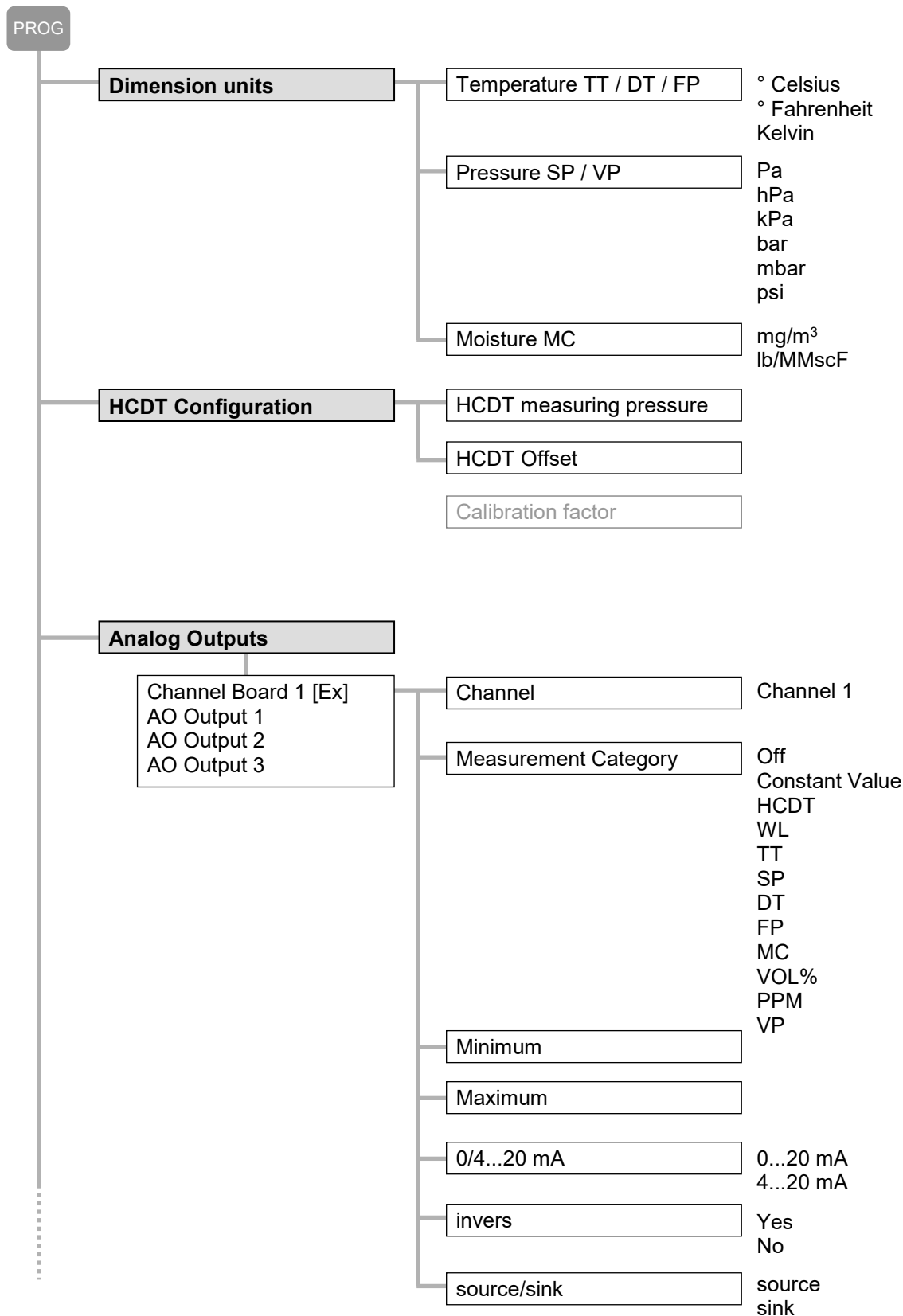

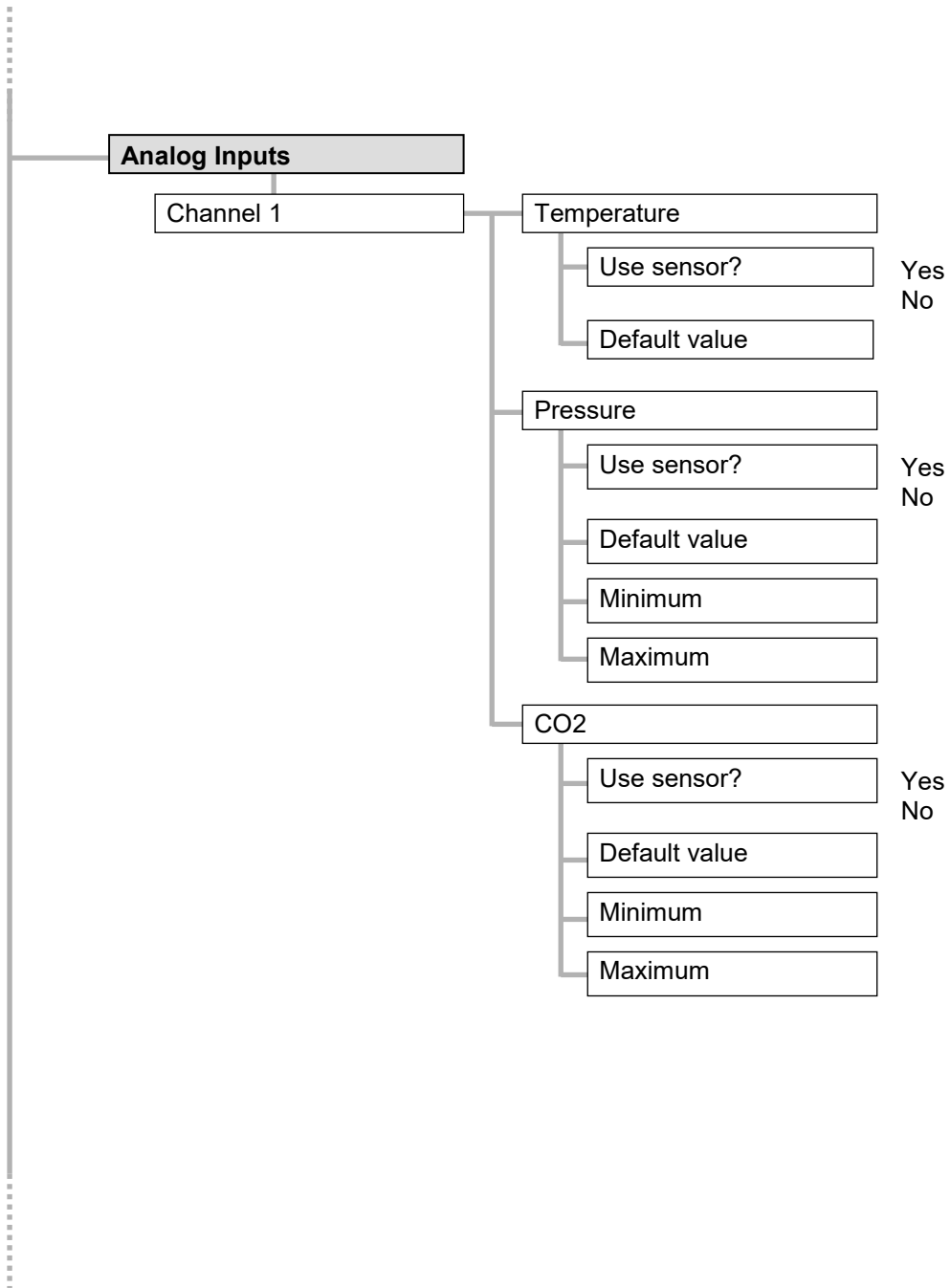

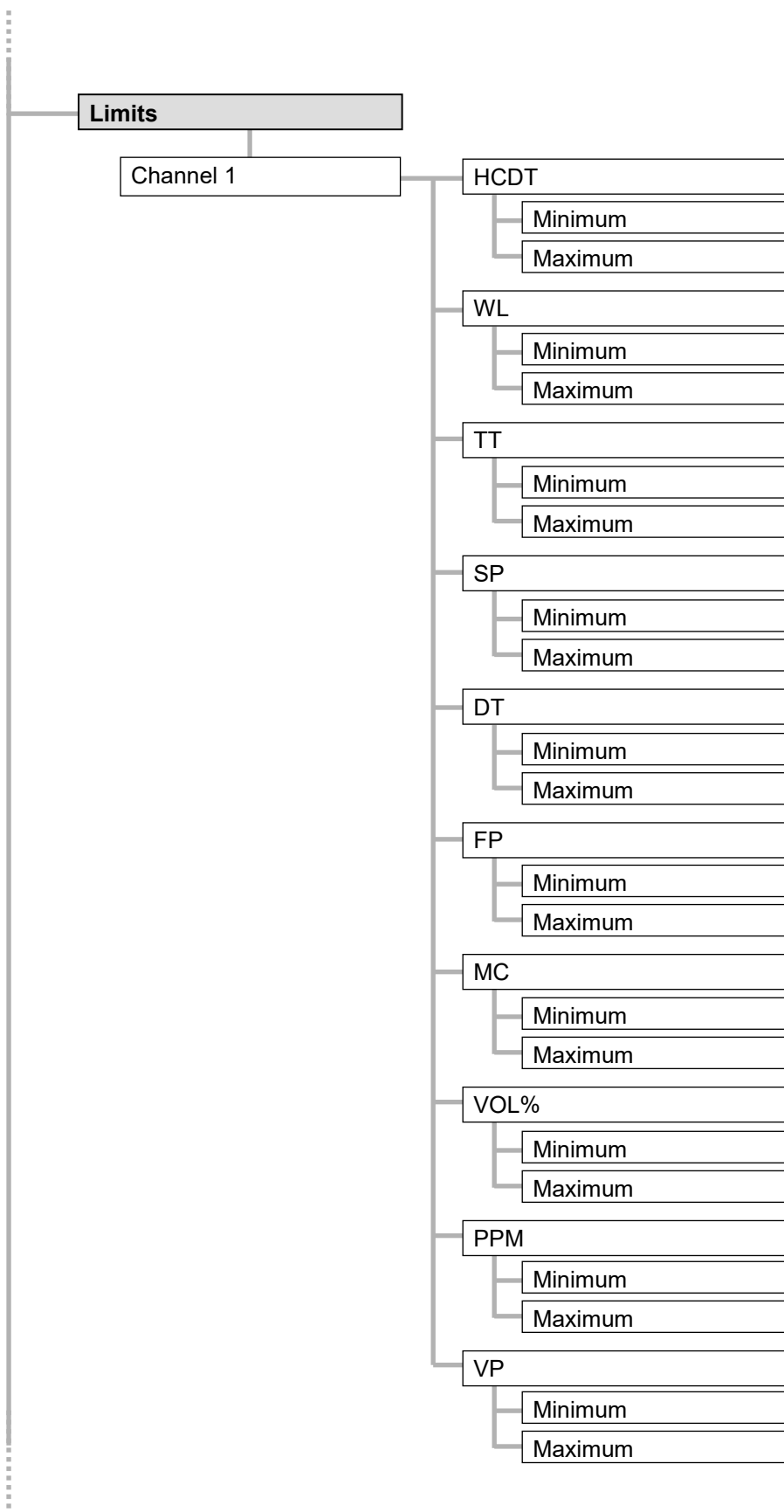



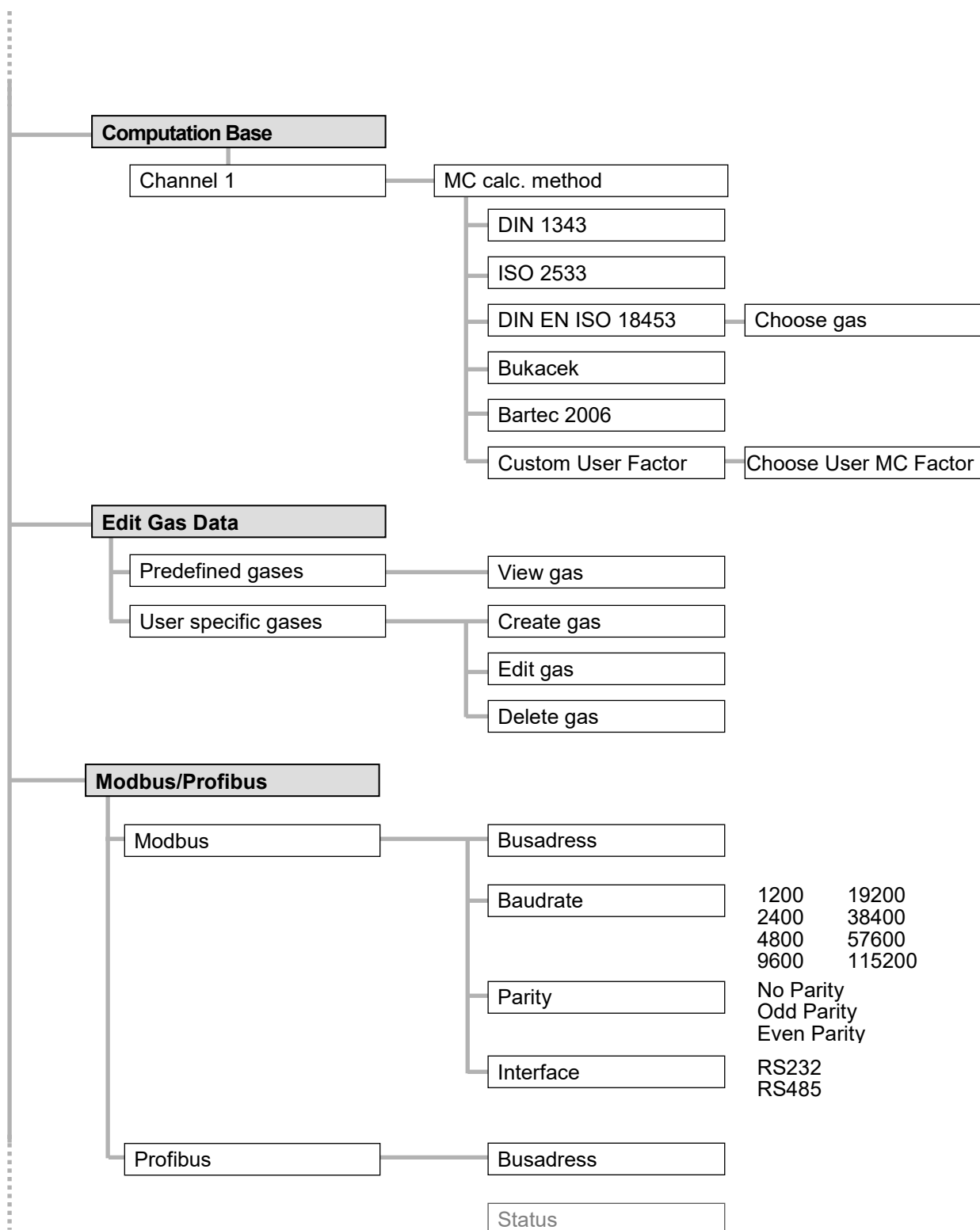

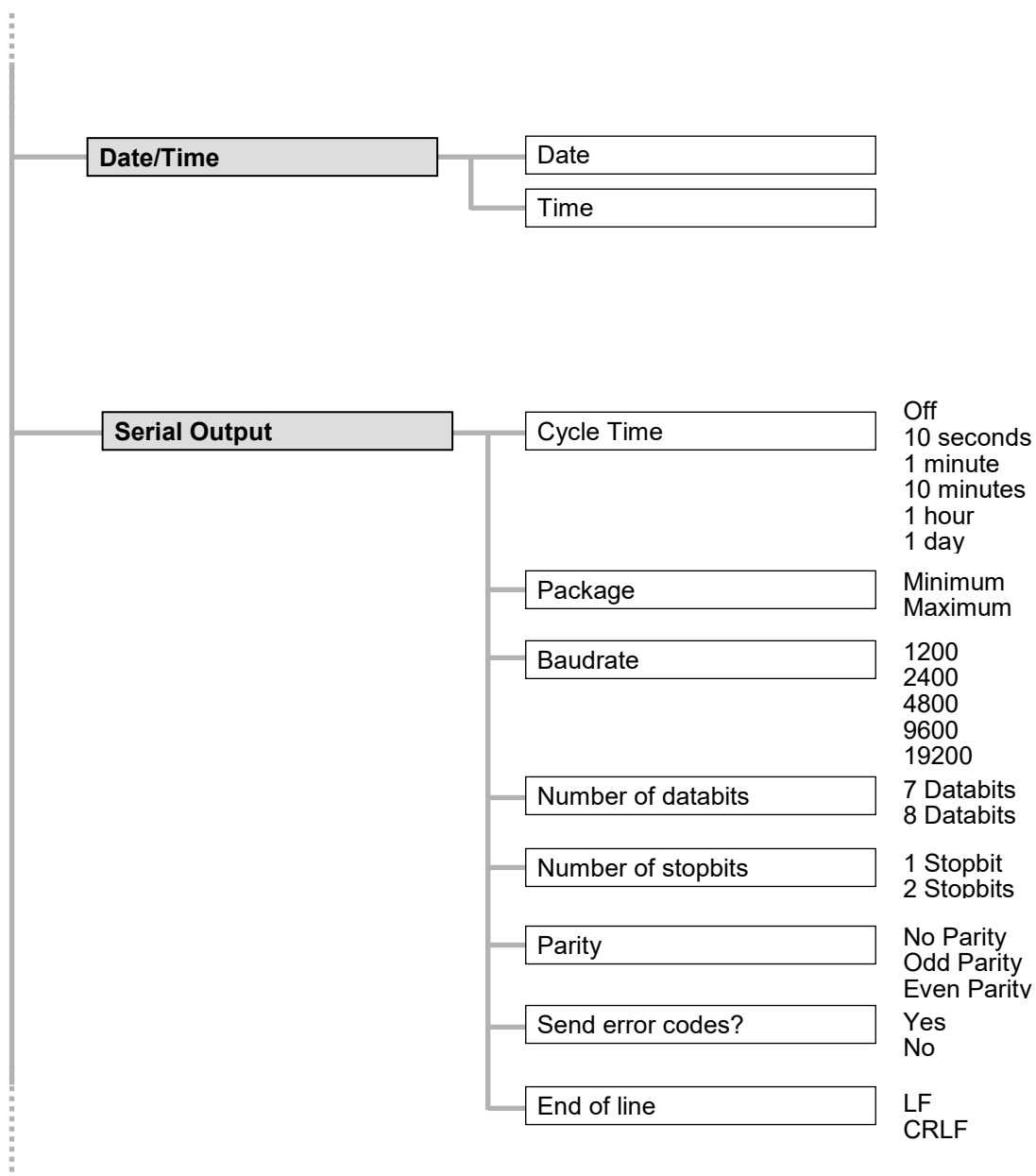

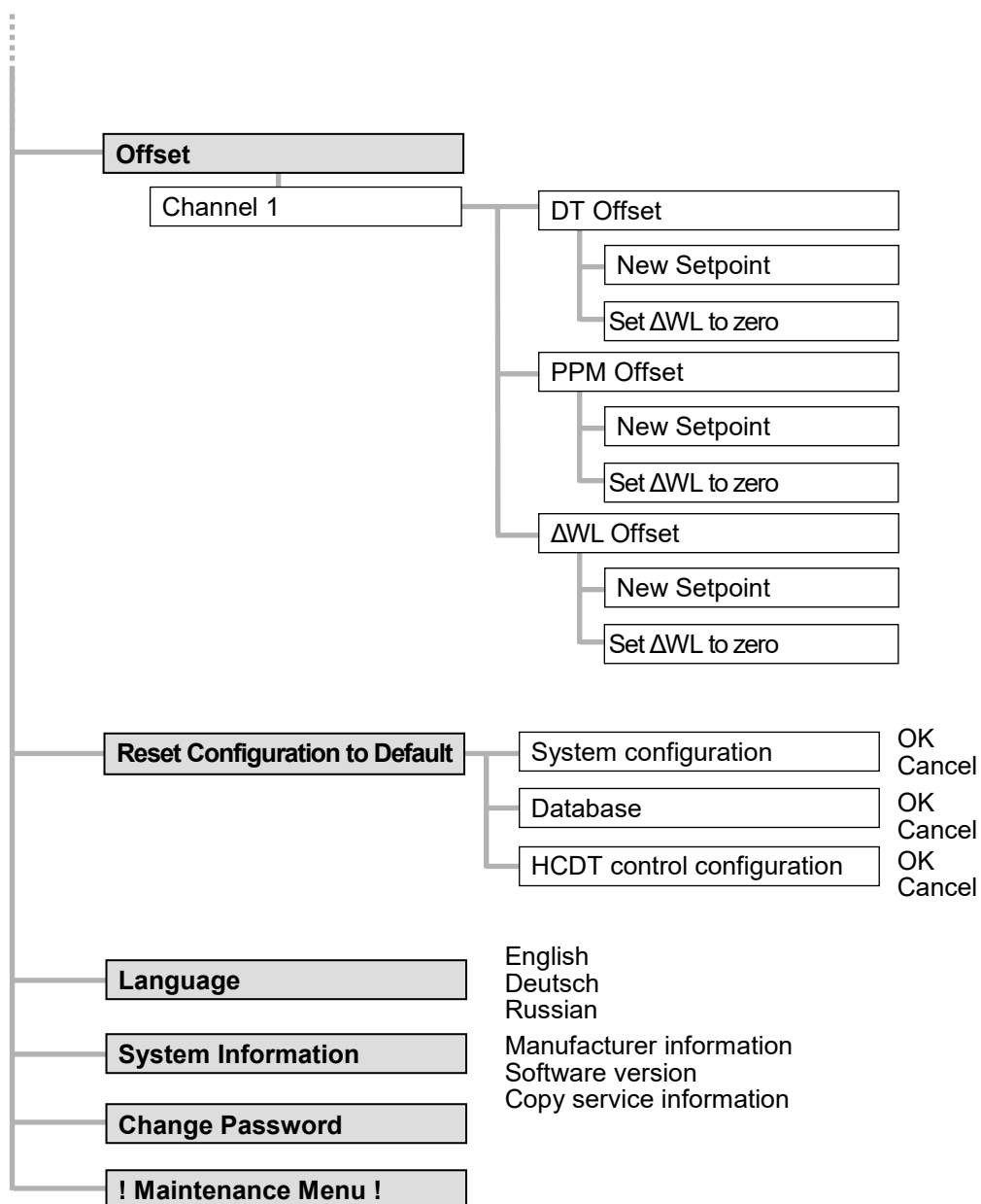

## 5.6 Program parameters

In this section the meaning of the individual parameters of all menus is explained.

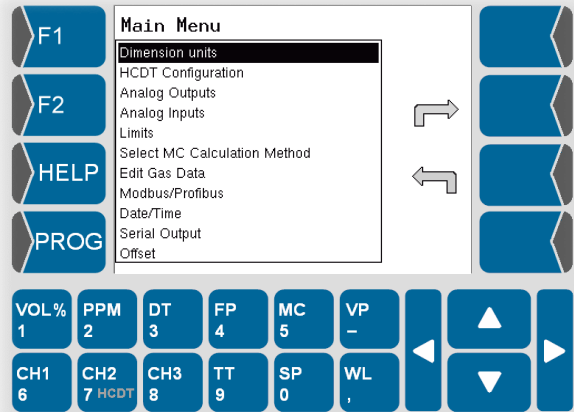

### 5.6.1 Dimension units

In this menu you can define the dimensions units for temperature, pressure and moisture content.

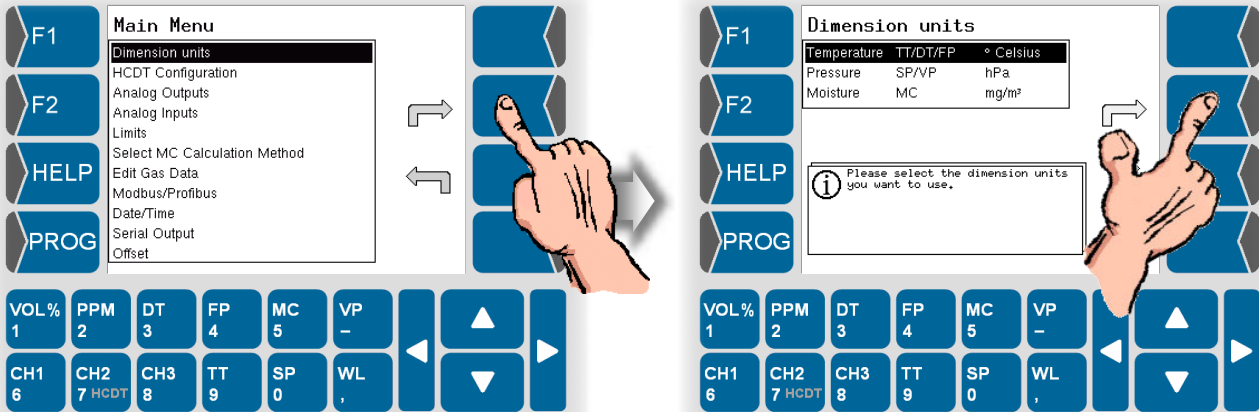

Measurement variable	Dimension
Temperature TT / DT / FP	°Celsius °Fahrenheit Kelvin
Pressure SP / VP	Pa hPa kPa bar mbar psi
Moisture Content MC	mg/m <sup>3</sup> Ib/MMscF

## 5.6.2 HCDT Configuration

This is the menu for configuration of the dew point determination of hydrocarbons.

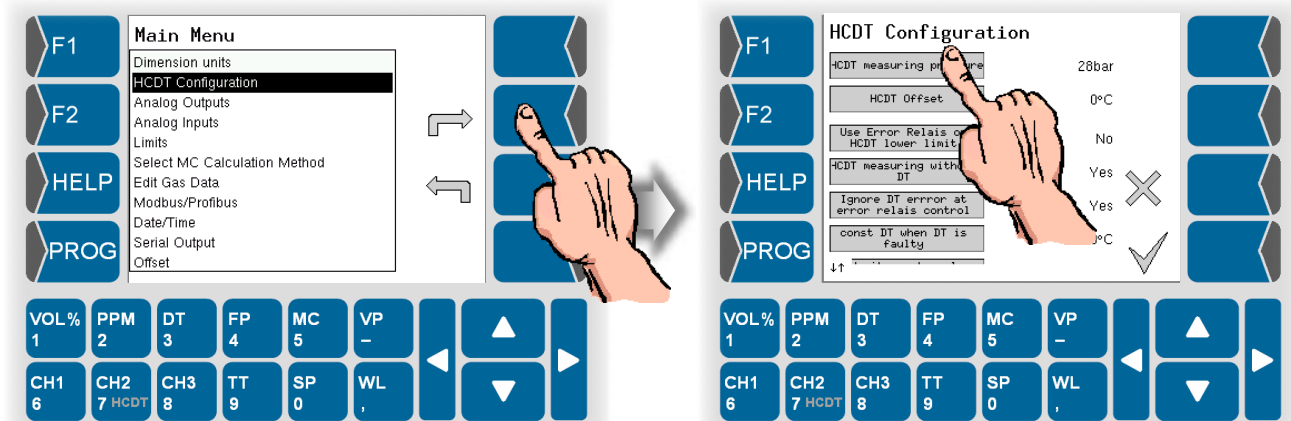

### HCDT measuring pressure

Pressure at which the dew point determination takes place. It should comply with the pressure at cricondentherm. The pressure is controlled in the sample-system.

Default value: 30 bar (resp. equivalent value in the configured pressure unit)

### HCDT Offset

If a reference thermometer indicates a differing temperature you can offset it by entering this difference here. If an offset is entered, the displayed HCDT dewpoint temperature is followed by an asterisk (\*).

### Use Error Relay HCDT lower limit

The error relay can be switched off. In this case, it does not decrease when the lower measuring limit is reached.

### HCDT measurement without DT

If the DT measurement fails, the HCDT measurement can be continued, but without knowing whether the detected value is a hydrocarbon or water dew point.

### DT constant value at DT failure

If the DT measurement fails and the "HCDT measurement without DT" function is activated, set an imaginary water dew point (as far below the expected HCDT value as possible) so that the HCDT measurement remains active. Range -100 to 100°C (standard: -40 °C).

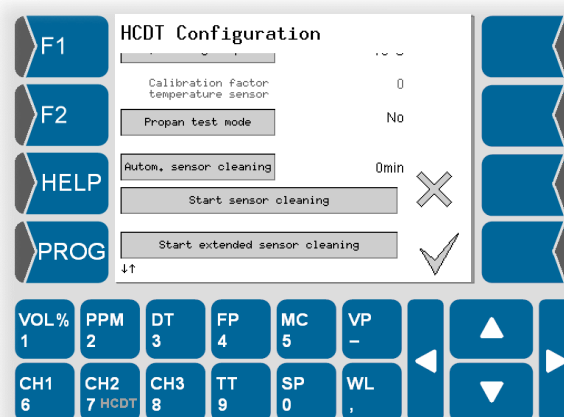

#### Calibration factor temperature sensor

The calibration factor is stored in the sensor. It is read by the software and will be displayed. The displayed calibration factor must be identical to the calibration factor engraved on the shaft of the sensor.

#### Propane test mode

Propane test mode allows the water to fall below the dew point and has its own threshold value.

#### Automatic sensor cleaning

After the set interval has elapsed, a prolonged heating process takes place at approx. 35 °C (maximum 4320 min adjustable).

#### Start sensor cleaning

After tapping this button, a prolonged heating process at a temperature of approx. 35 °C is started.

#### Start extended sensor cleaning

After tapping this button, a prolonged heating process is started at a higher temperature of approx. 55 °C.

## 5.6.3 Analog outputs

- Open the menu „Analog outputs“.First select one of the analog outputs to program the output values.

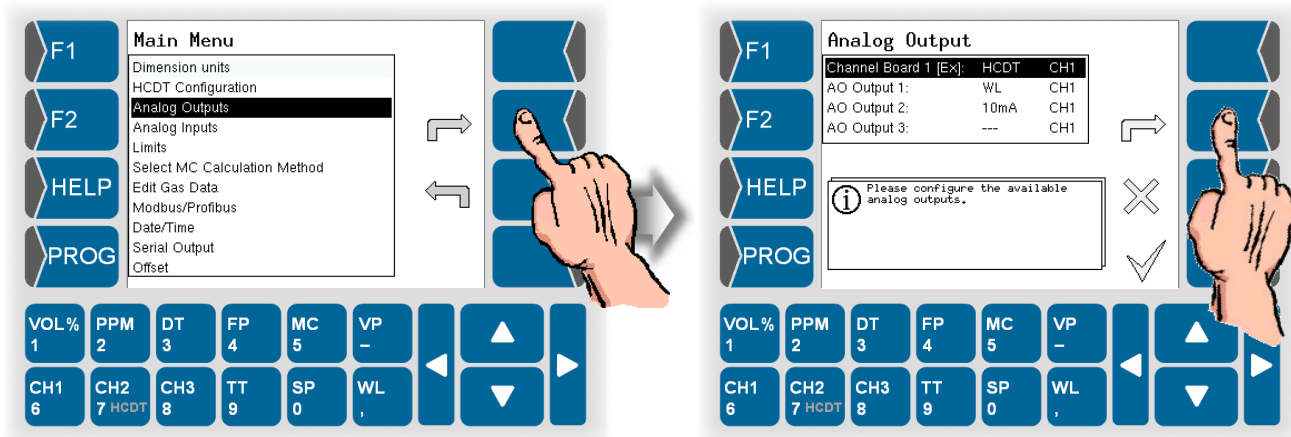

Then the programming of the selected analog output takes place.

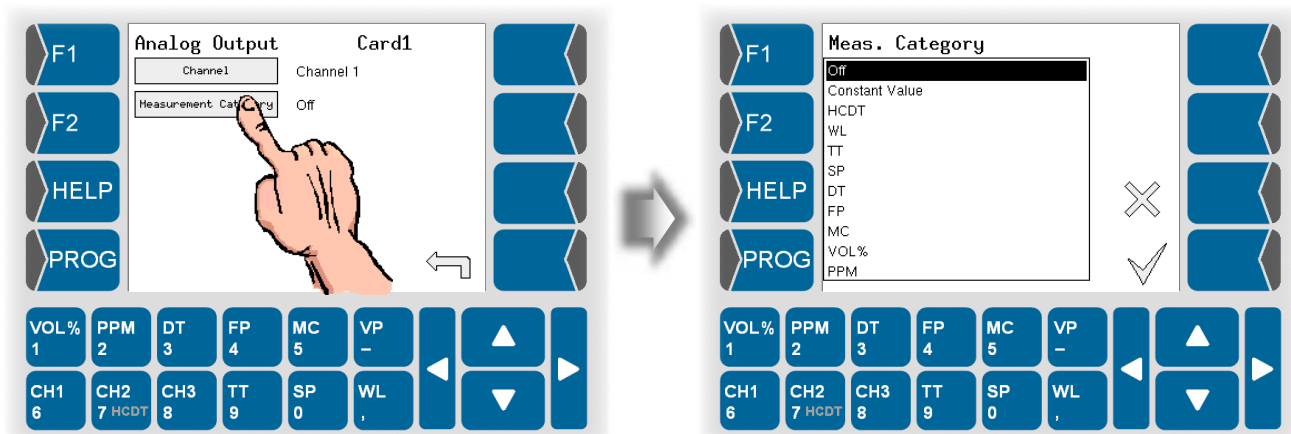

Channel

With HCDT measuring is only one channel available.

Measurement Category

Select the measurement variable to be issued at the selected analog output.

With the **“Off”** setting happens no current output at the selected analog output. In this case are no further parameter settings available (see fig. above).

You can define a **constant value** to be output continual instead of a measuring variable. In this case you must just define the value in the range of 0...20 mA.

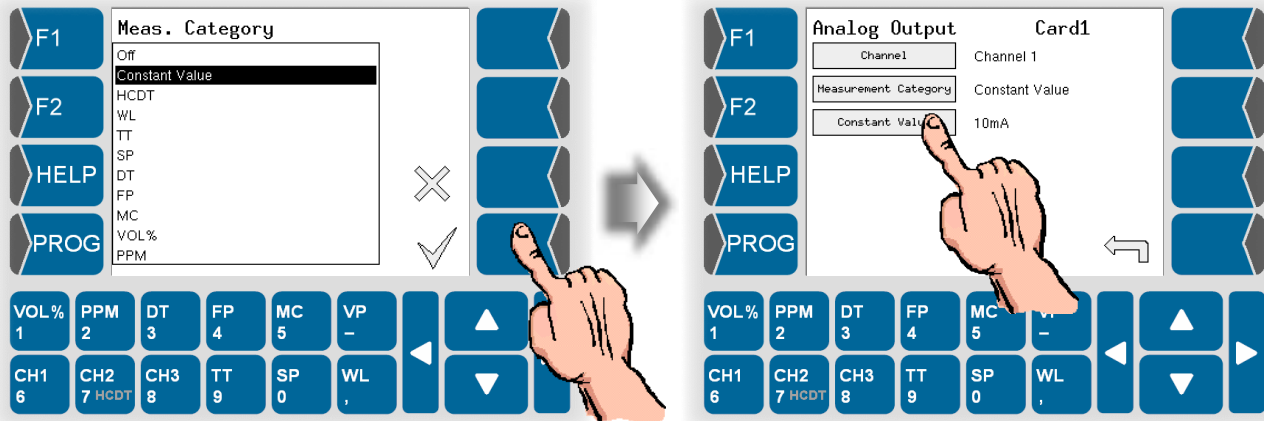

If you have selected a **measuring variable** to be output at the selected analog output, you must configure further parameters.

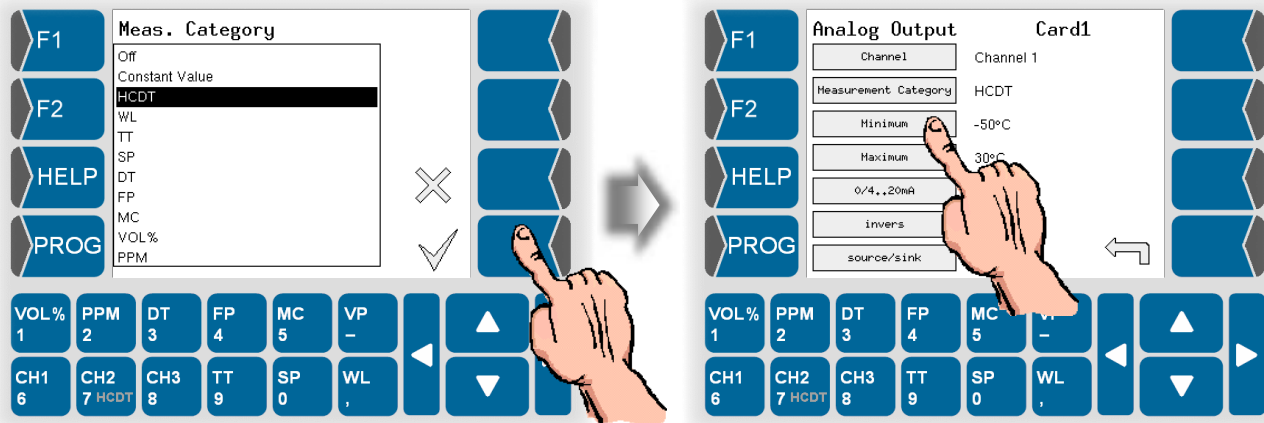

For each measurement variable you can define a measurement value range to be evaluated. This range has to be within the possible total measurement range. You can define the measurement value range with the parameters „Minimum“ and „Maximum“.

- Minimum                      Setting of the minimum value for the measurement variable displayed at the analog output. This value corresponds to 0 and 4 mA respectively.
- Maximum                     Setting of the maximum value for the measurement variable displayed at the analog output. This value corresponds to 20 mA.
- 0/4...20                      Select the output current range for the analog output (0...20 mA or 4...20 mA).
- invers                         If you invert the analog output, the output current is issued inversely proportional to the measured value.
- source / sink                 The current signal of the channel board can function as a source (current is issued) or as sink (current is consumed).  
*With the analog outputs of the COM board („AO output 1...3“) is the output signal always „source“.*



## 5.6.4 Analog inputs

- Open the menu „Analog inputs“.
- With HCDT measuring is only one channel available. Confirm the channel.

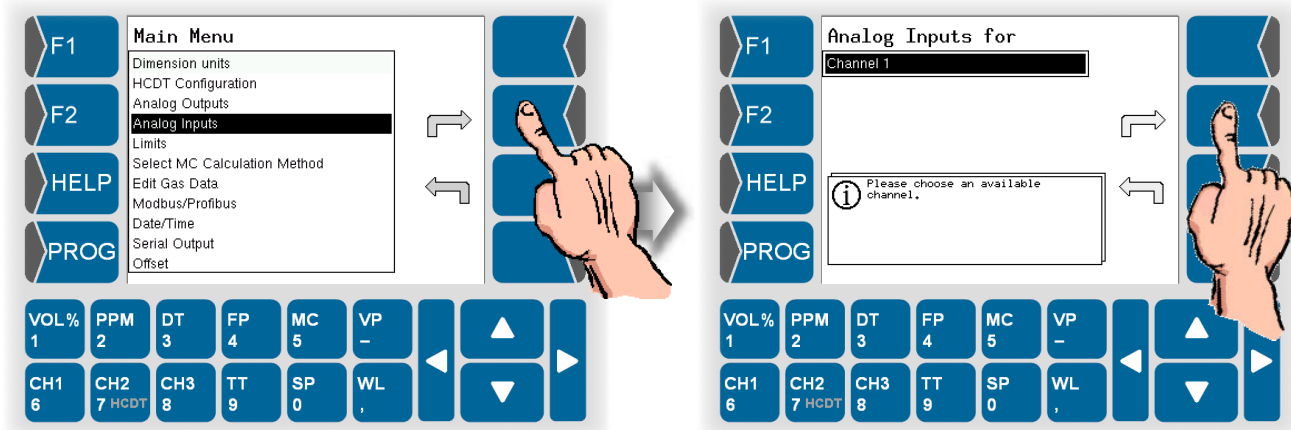

- Then select the measurement variable to be measured via the measurement channel.

### 5.6.4.1 Temperature

- Define whether to use a temperature sensor or not.
- Under Default value, enter a fixed value. This fixed value will be applied if no sensor is used.

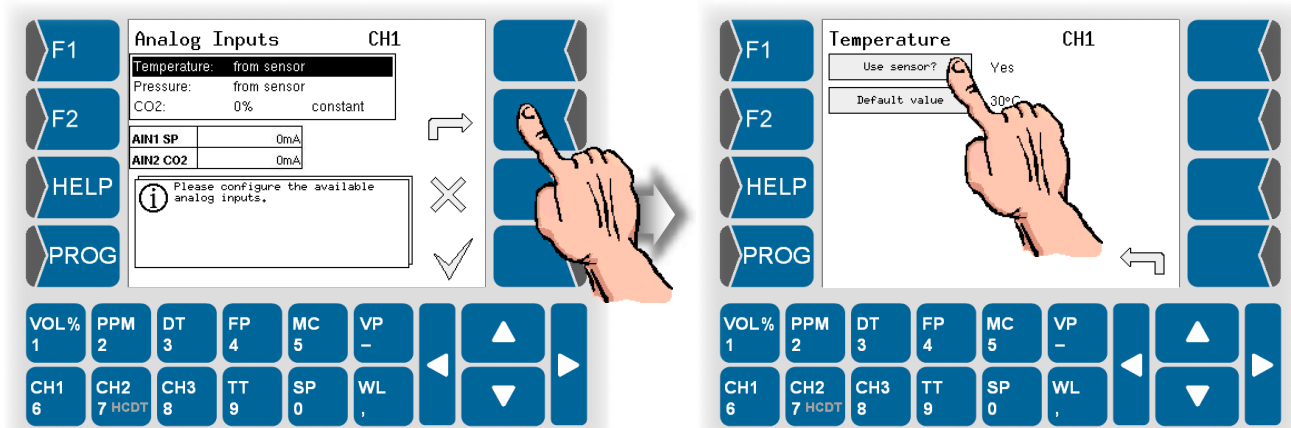

### 5.6.4.2 Pressure

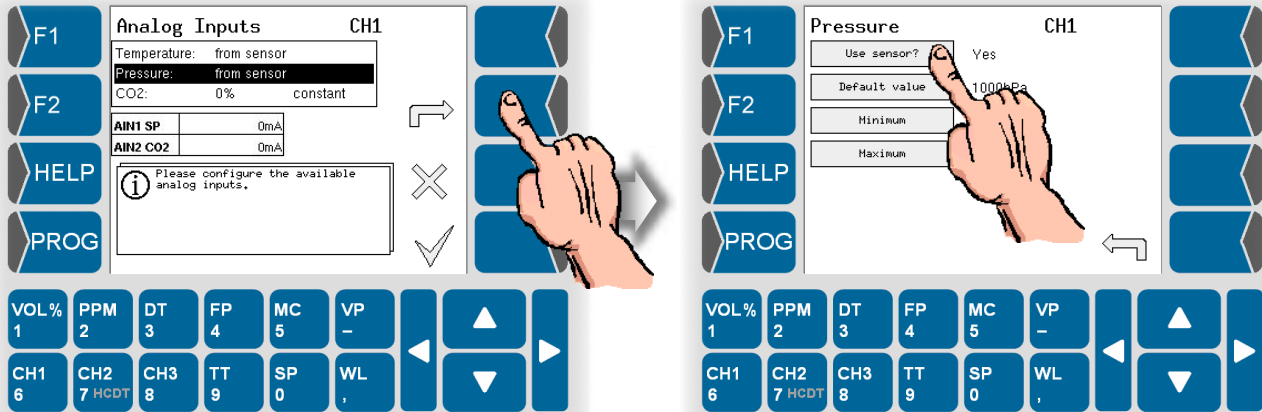

- Define whether to use a pressure sensor or not.
- Under Default value, enter a fixed value. This fixed value will be applied if no sensor is used.
- Define the measurement range for the current input of pressure. The minimum value corresponds to an input current of 0 and 4 mA respectively, the maximum value corresponds to 20 mA.

## 5.6.5 Limits

It can be checked whether the values that have been measured or calculated do not infringe the limit values.

- Open the menu „Limits“.
- With HCDT measuring is only one channel available. Confirm the channel.

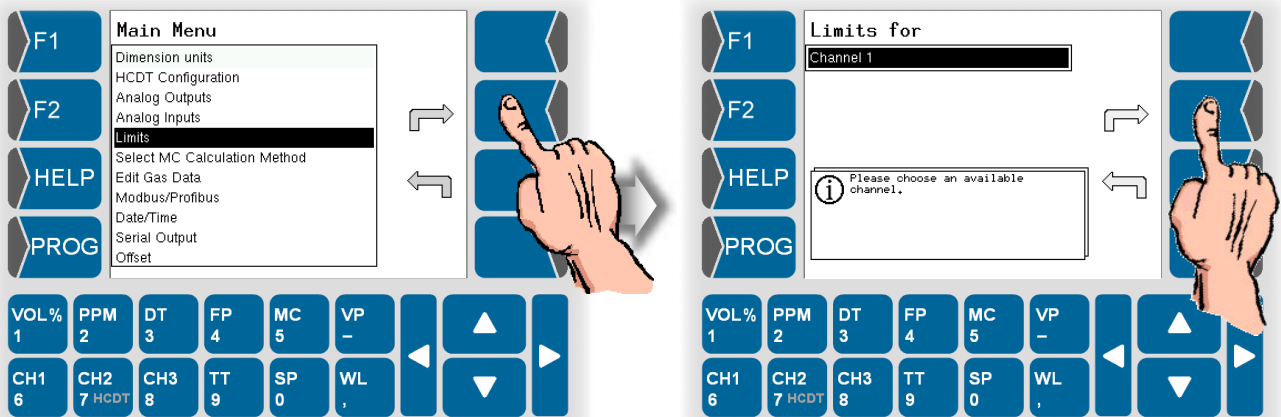

- Select the measurement variable. The currently valid limits are displayed.
- Enter the required minimum and maximum values.

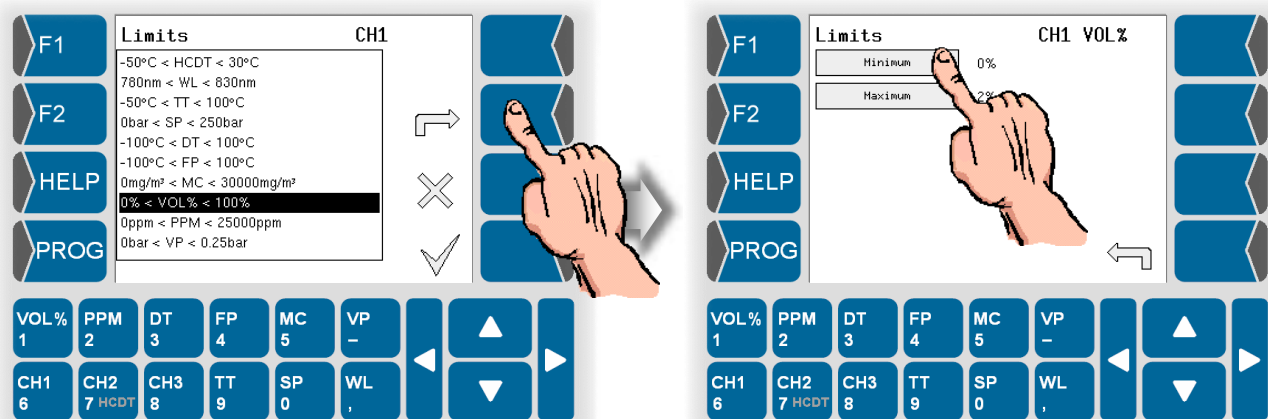

If a value either exceeds or falls below any limits, a signal is issued via an optocoupler.

Icons in the display show that a limit has been exceeded or fallen below (see section 4.3.1.4 and 4.3.1.6).

## 5.6.6 Selecting the MC Calculation Method

When using HYGROPHIL® F 5673 you can select different methods for calculating the moisture content MC [mg/m³, lb/MMscf].

- Open the menu “Computation base”.
- Choose “Select MC calculation”.
- With HCDT measuring is only one channel available. Confirm the channel.

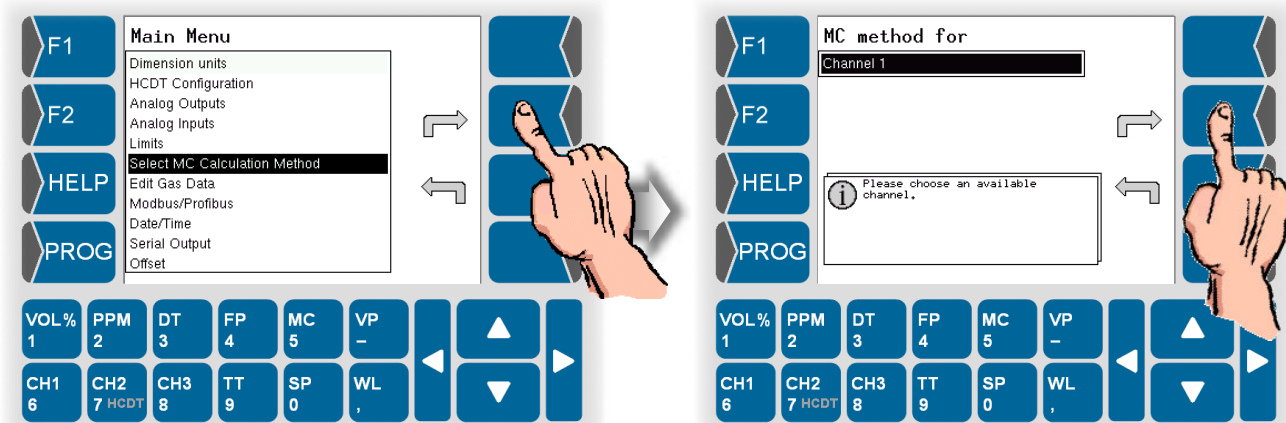

- Select the method for calculation MC.

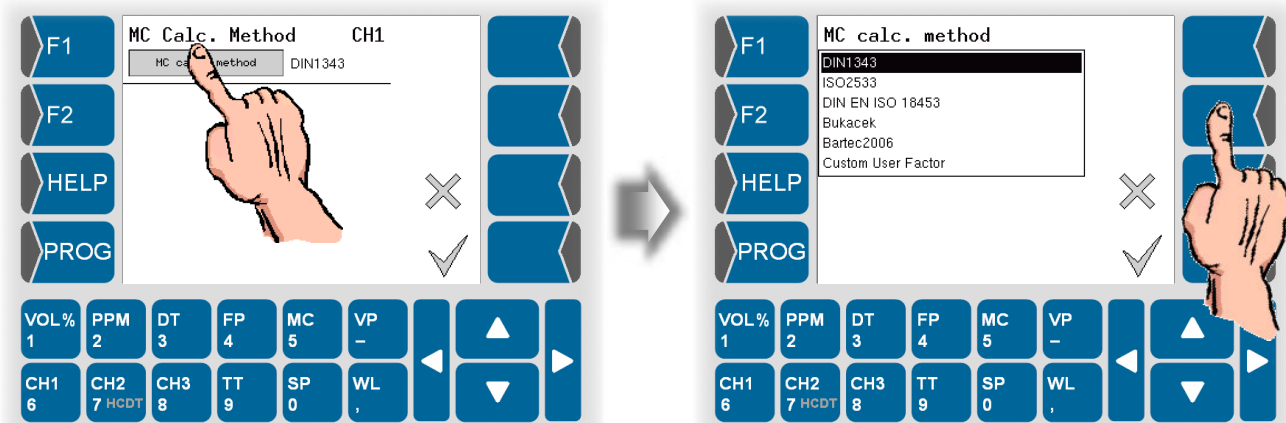

DIN 1343  
 ISO 2533  
 DIN EN ISO 18453  
 Bukacek  
 Bartec 2006  
 Custom User Factor

You must do further settings when using the calculation method DIN ISO 18453 or Custom User Factor (see below).

### DIN EN ISO 18453

DIN EN ISO 18453 „Erdgas – Beziehung zwischen Wassergehalt und Taupunkt“ defines a method for calculation of water content from the dewpoint under conditions which are typical for natural gas.

The calculating tolerances defined in this standard apply for the pressure range from 0.5 MPa to 10 MPa and a water dewpoint in the range of -15 °C to +5 °C. The expanded working range includes pressure from 0.1 MPa to 30 MPa.

- Select the calculation method DIN EN ISO 18453.

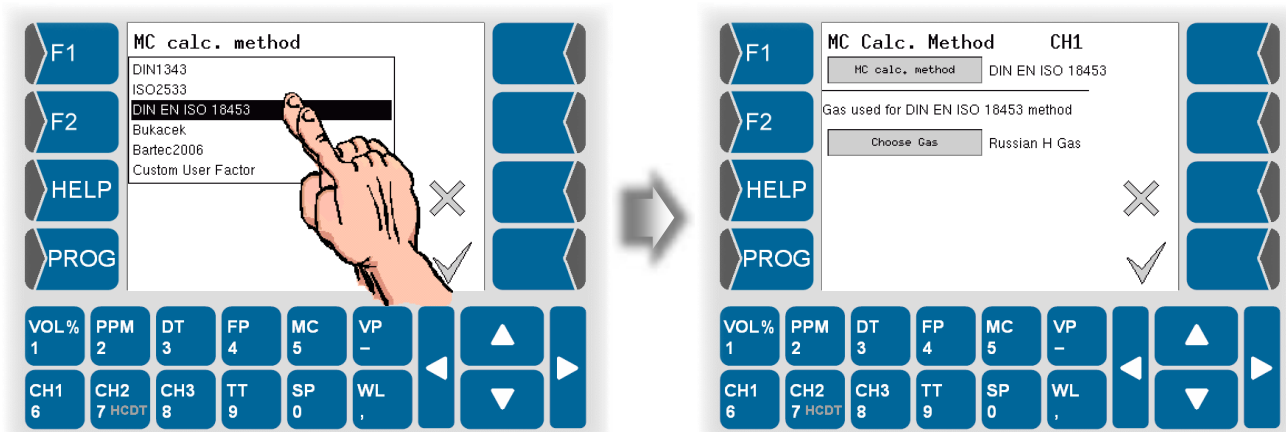

- Select the gas for which the calculation is to apply.

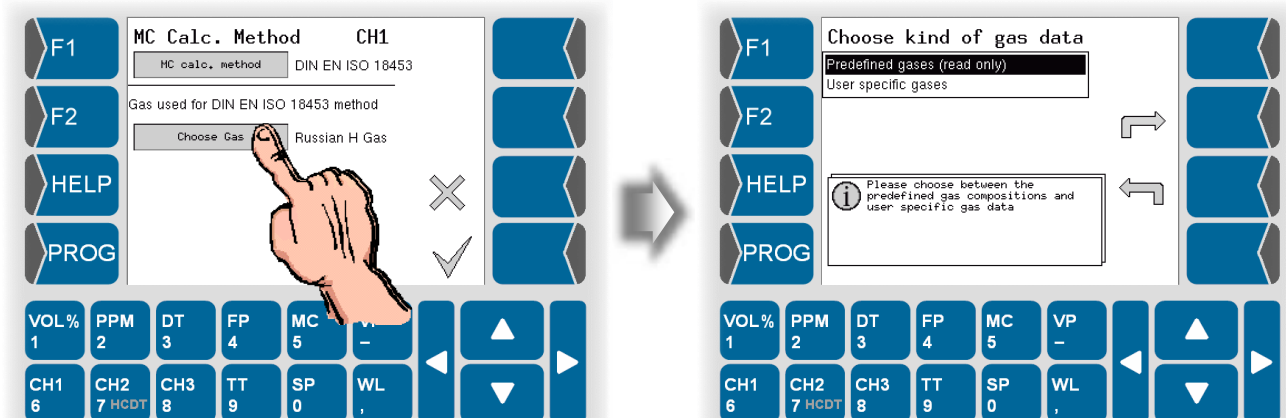

You can choose the gas from a list of predefined gases (see section 5.6.7.1) or from a list of user specific gases (see section 5.6.7.2).

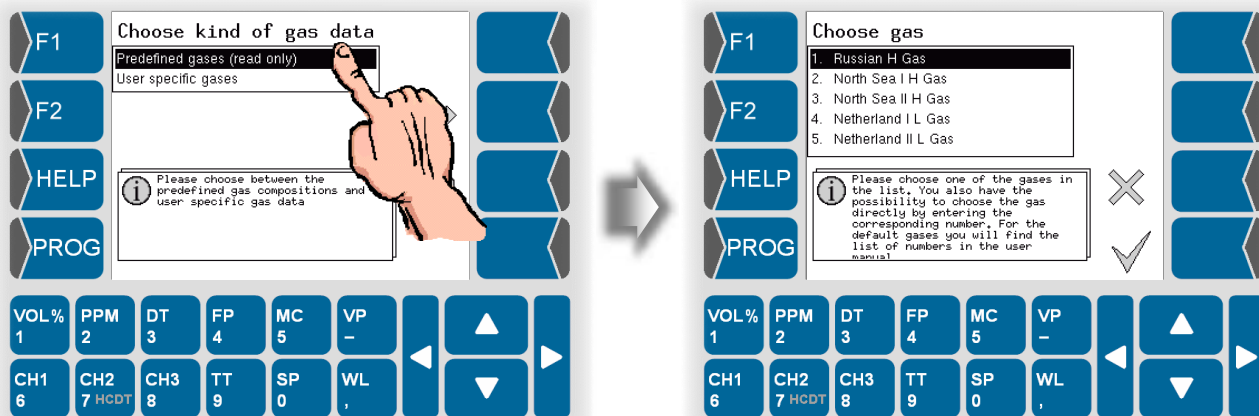

### Custom User Factor

For special needs you can define a factor for the conversion ratio of ppmV to MC.

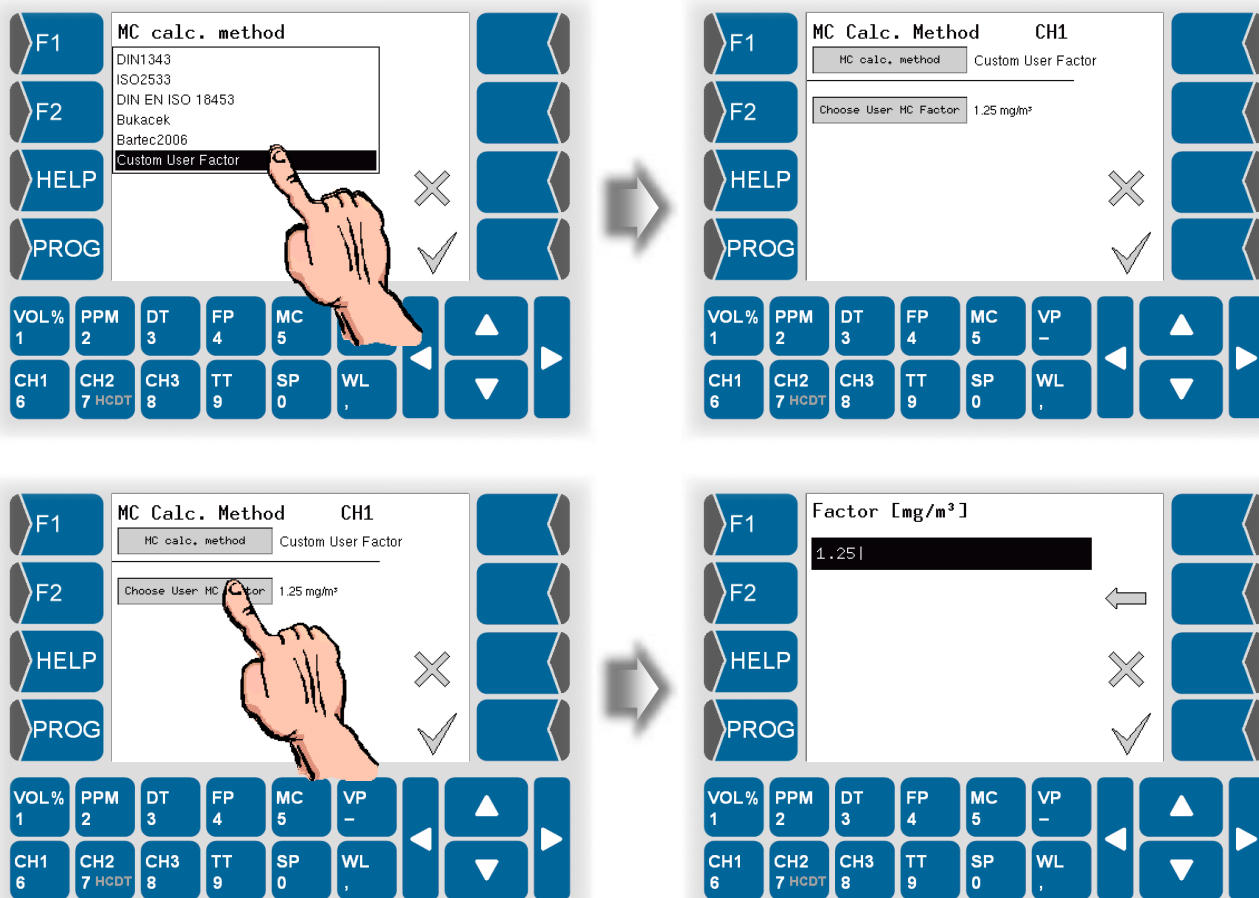

Further information and changes, see Chapter 10 “Add-on,” starting on page 10-4.

## 5.6.7 Edit Gas Data

The menu is used to view and edit the composition of user specific gases as well as to view the composition of predefined gases.

- Open the „Edit Gas Data“ Menu. Then choose, if you want to view the predefined gases or the user specific gases which can also be edited.

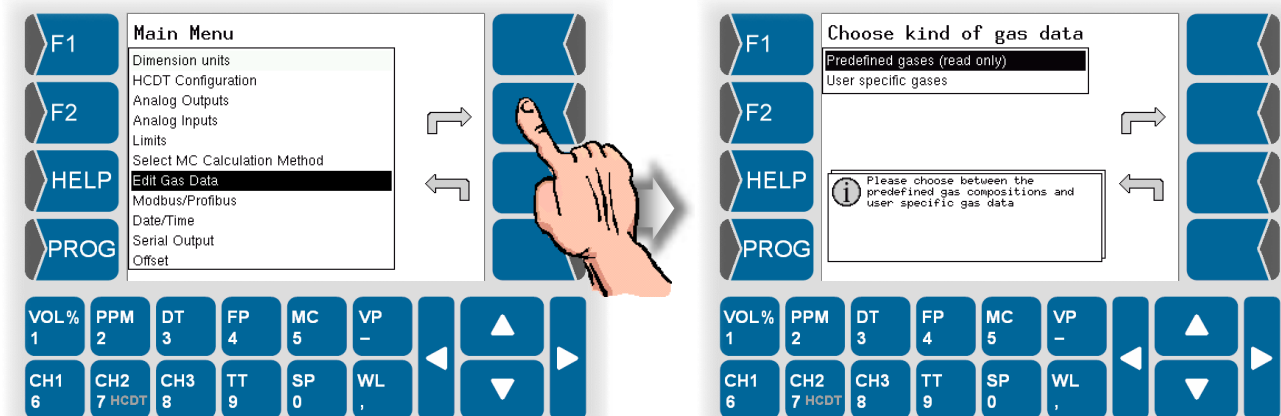

### 5.6.7.1 Predefined gases

A list of predefined gases exists already when the measuring system is delivered. You cannot modify the content of this list but you can view the definition of the composition of all gases.

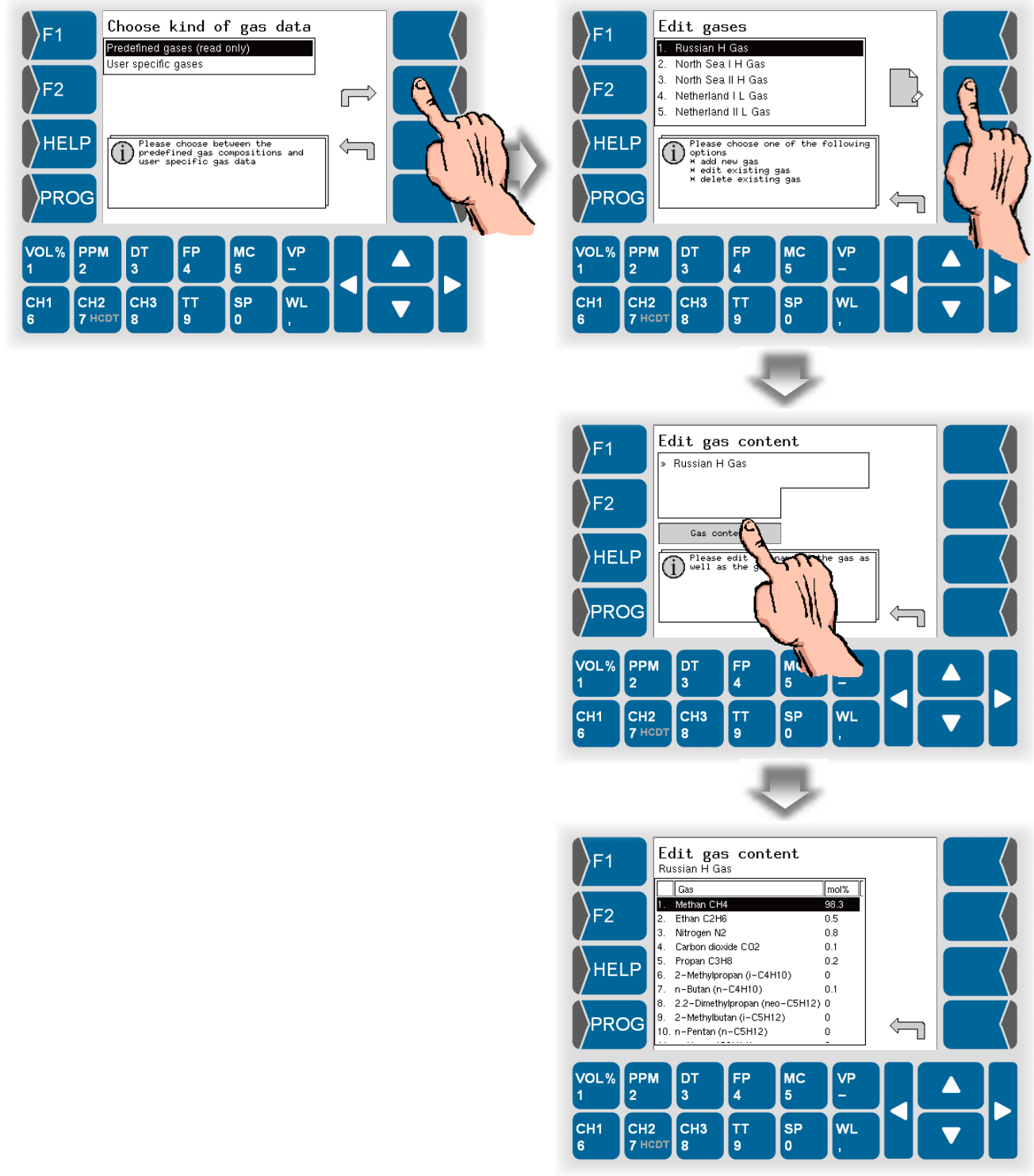

There is a table showing the composition of the predefined gases at page 9-3.

Source for the list of predefined gases is the worksheet G 260 of DVGW (Deutsche Vereinigung des Gas- und Wasserfaches e. V.).



### 5.6.7.2 User specific gases

There are no user specific gases entered when the measuring system is delivered. You can define gases of any composition according to the special requirements of the measuring task.

- Open the „User specific gases“ menu.

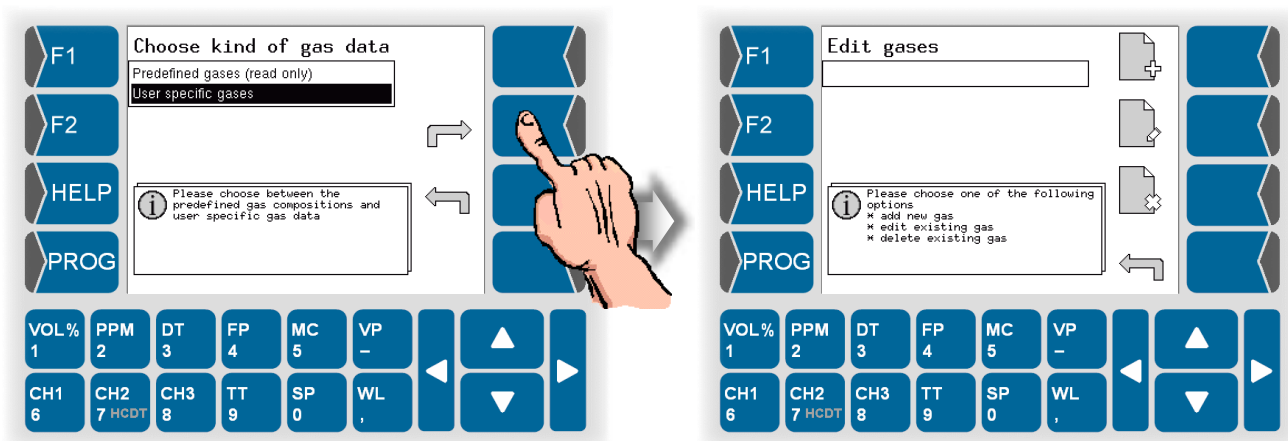

Then the following options are available:

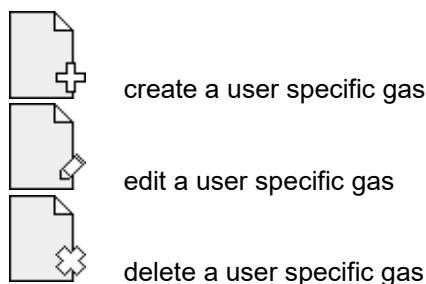

#### Create a user specific gas



- Touch the „create a user specific gas“ softkey. A gas named „New Gas“ is created.

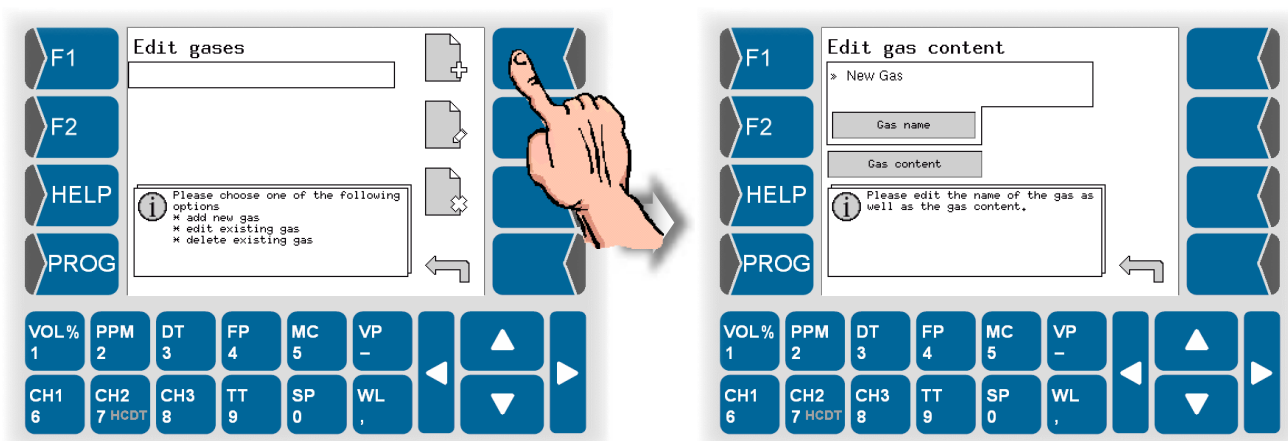

- Touch the Gas name button. Use the following dialog to change the name of the gas.

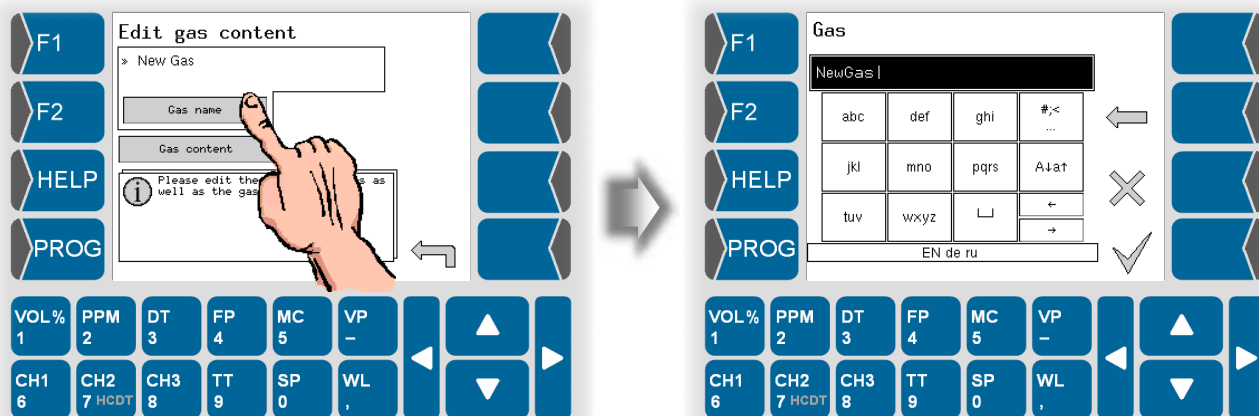

Letters are entered using the keys that are shown on the display. To enter a letter, simply touch the corresponding key. The keys are assigned up to four characters. You determine which character appears in the input line by pressing the key the appropriate number of times in quick succession. You can enter a blank with the | key.

You can use the A|a↑ key to switch from upper case to lower case letters and vice versa.

If special characters need to be entered, you can use the #;< key to switch the key assignment to the special character level. You can switch back to letters using the same key, which is now labelled abcä.

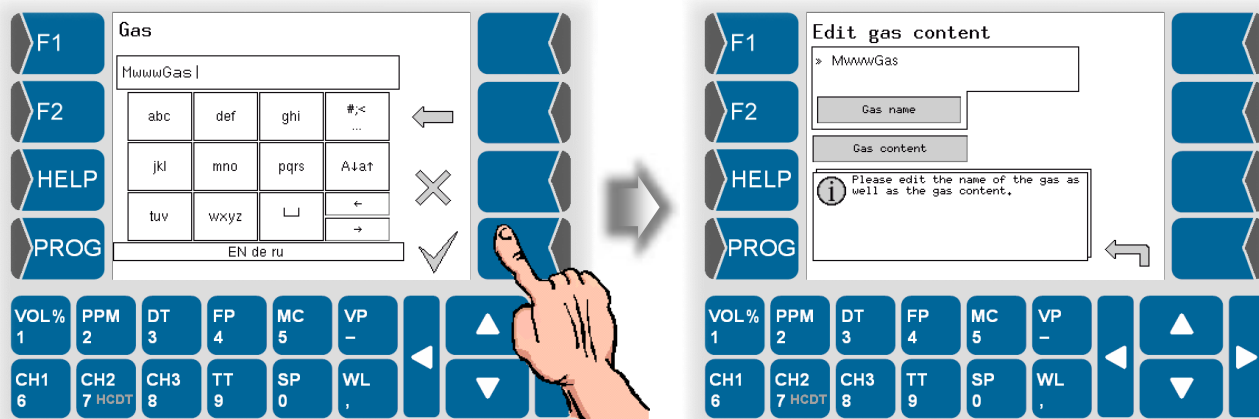

With the next step you must enter the composition of the gas.

- Touch the **Gas content** button.

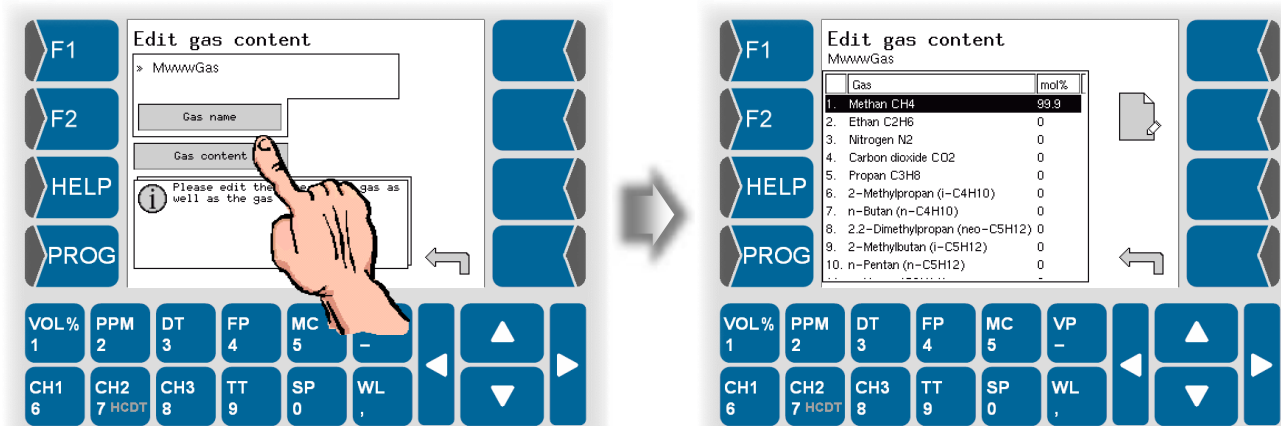

- Select one of the components of the mixture by using the arrow keys or touching the corresponding numeric key.
- In the following dialog enter the percentage of the selected substance.
- Confirm the entry by ✓.

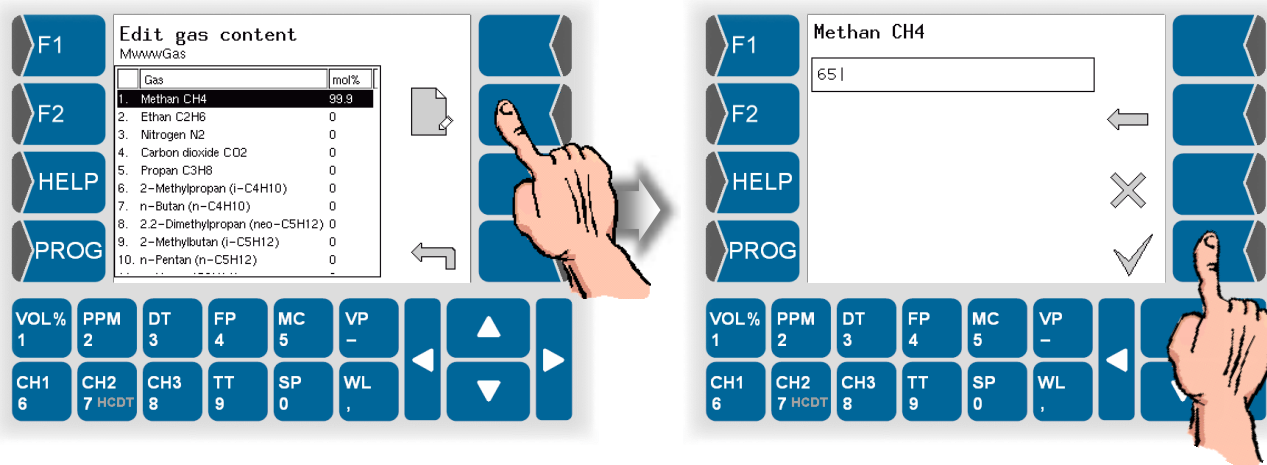

- Repeat the entry of the percentages for all other substances in the gas mixture.

When entering the gas content, the software checks the validity of the entries. If entries are outside of the measuring range or if the sum would exceed 100% is an accordingly message displayed.

**Example**

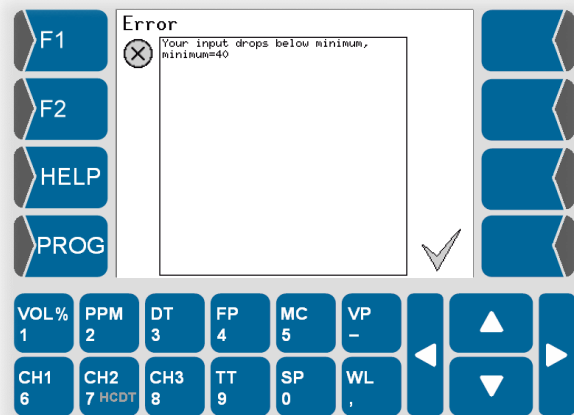

**Example**

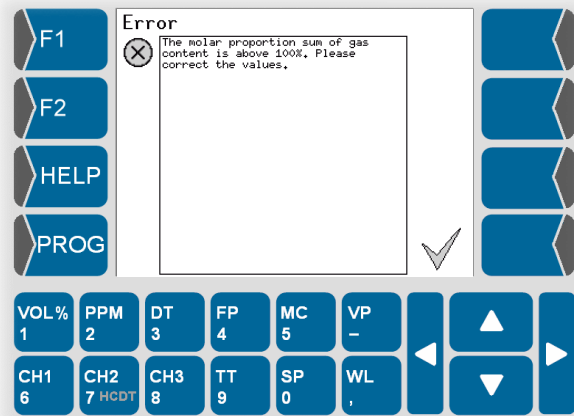

**Edit a user specific gas**



Select the gas, whose data you want to edit. Touch the „Edit“ softkey. Then you can edit the name and the composition of the gas as described above.

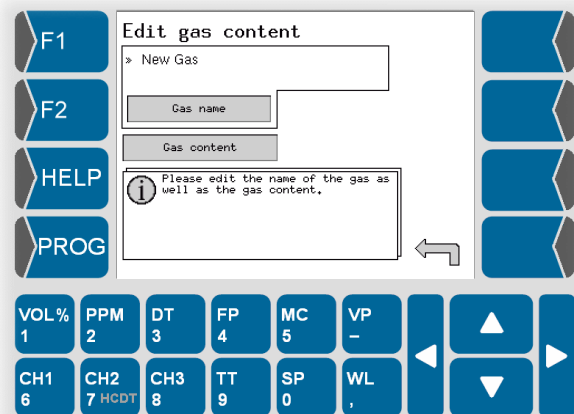
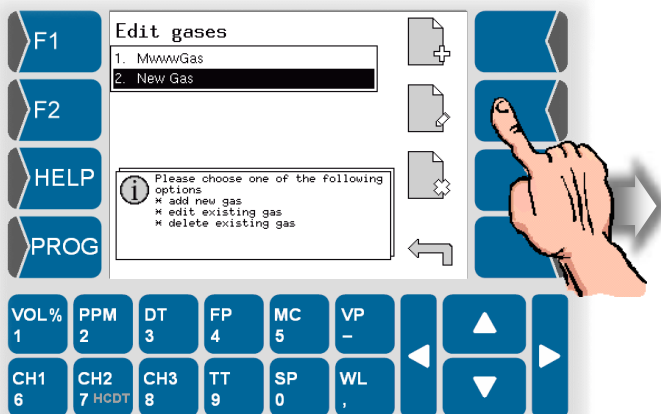

## Delete a user specific gas



Select the gas that you want to delete from the list. Touch the „Delete“ soft-key.

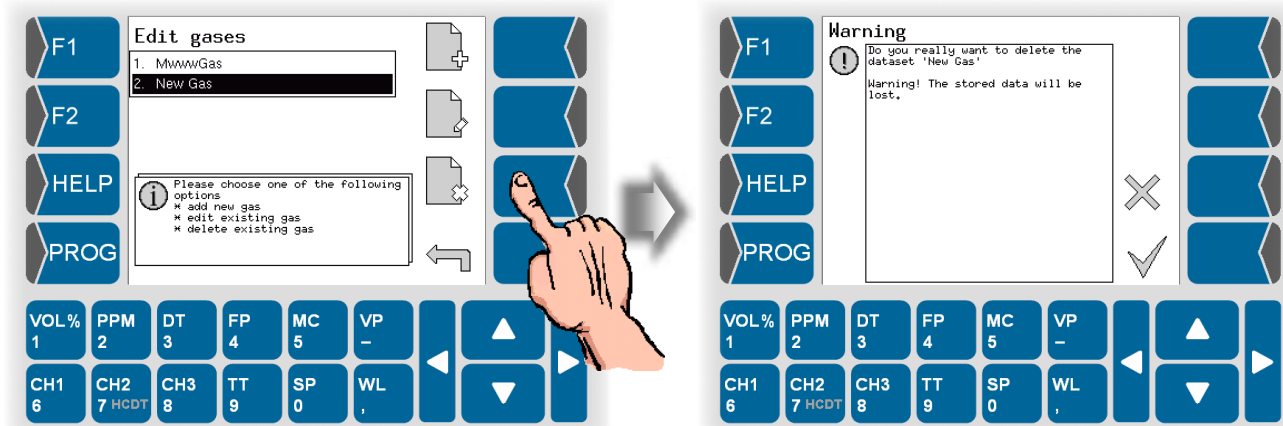

After confirming the warning is the selected gas deleted from the list.

The gas can also be deleted if it is already assigned to the measuring channel.

In this case you must update the configuration of the MC calculation.

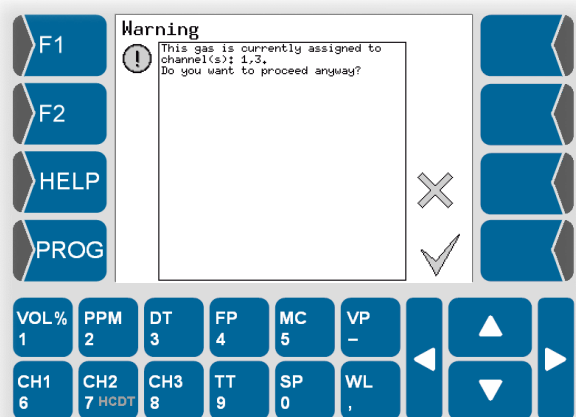

## 5.6.8 Modbus/Profibus

Use this menu to configure the measuring system for operating in a bus system (modbus or profibus).

- Open the menu „Modbus/Profibus“.
- Set the parameters according to the applied bus system.

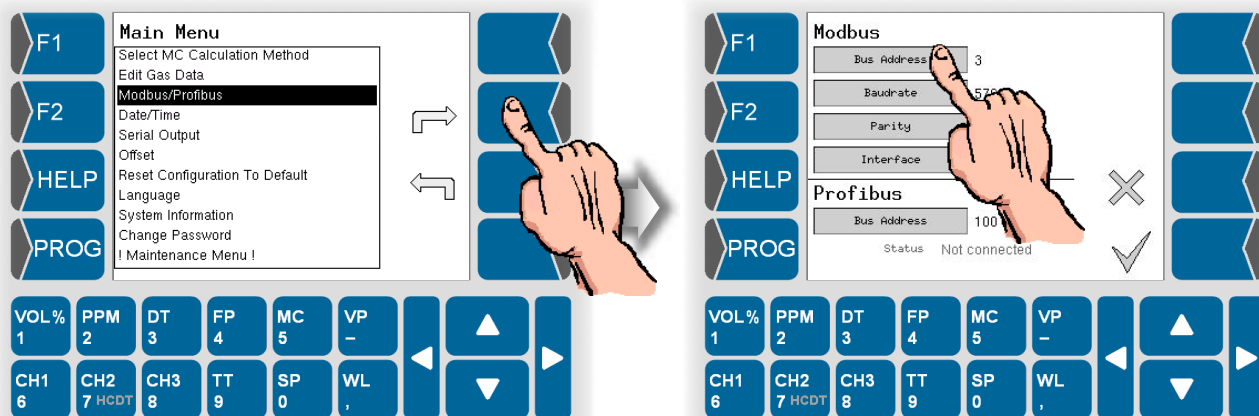

Parameter	Possible settings	Comments
<b>Modbus</b>		
Bus Address		Address of the measuring device  <b>Notice: You can only enter a subnet mask using a suffix for the IP address.</b>  example: IP: 192.168.0.30, subnet mask: 255.255.255.0 enter: 192.168.0.30/24
Baudrate	1200 2400 4800 9600 19200 38400 57600 115200	
Parity	No Parity Odd Parity Even Parity	
Interface	RS232 RS485	choosing the type of interface to be used
<b>Profibus</b>		
Bus Address		Address of the measuring device
Status		Display of status information

Detailed information to the bus systems see section 8.

## 5.6.9 Date and time

- Open the menu „Date/Time“.
- Set the current date and time.

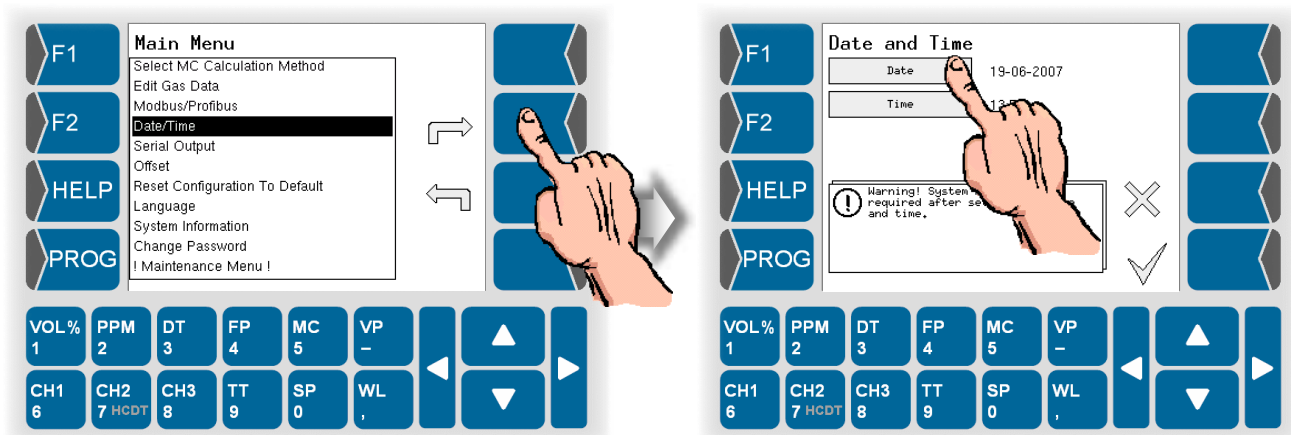

Please mind that the device will be rebooted if you save these settings. Do not implement these settings if the ongoing measurement process must not be interrupted!

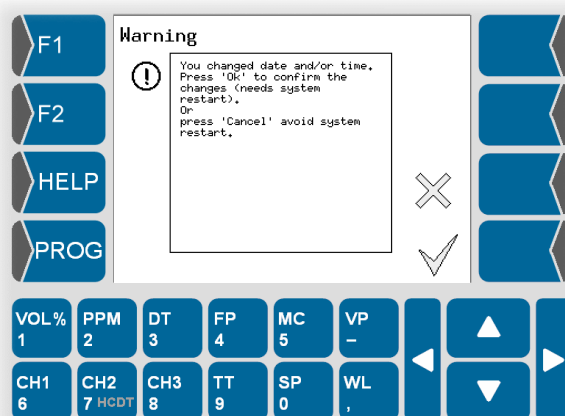

If you change the date or the time, the operating voltage has to be applied until the device is back in the measuring operation mode. Disconnection of the voltage will cause a data loss.

This message appears during the restarting process:

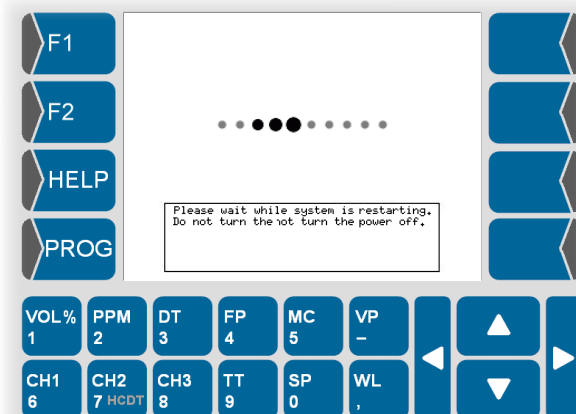

## 5.6.10 Serial output

- Open the menu „Serial output“.
- Set the parameters of the serial output as required.



Use the arrow keys to scroll the window.

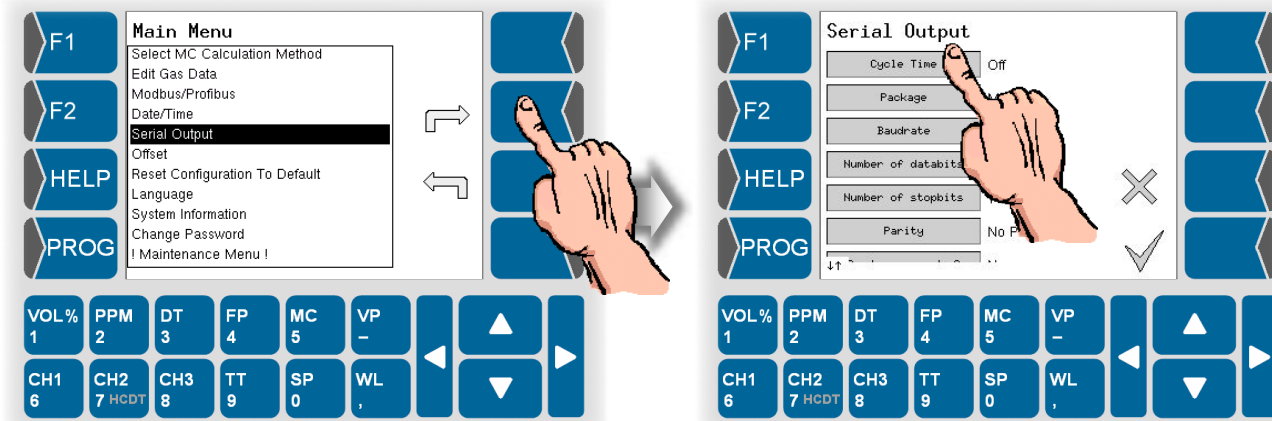

Parameter	Possible settings	Comments
Cycle Time	Off 10 seconds 1 minute 10 minutes 1 hour 1 day	Time interval after which there is an output to the serial interface.
Package	Minimum Maximum	Number of measurement variables issued per record. (Min: Date, Time, Channel, TT, SP, HCDT, DT, state of ERROR-relay, state of Limit-relay) Max: Date, Time, Channel, TT, SP, WL, VOL%, PPM, DT, FP, MC, VP, HCDT, SI, Tglass, Tenv, state of ERROR-relay, state of Limit-relay)
Baudrate	1200 2400 4800 9600 19200	
Number of databits	7 Databits 8 Databits	
Number of stopbits	1 Stopbit 2 Stopbits	
Parity	No Parity Odd Parity Even Parity	
Send error codes?	Yes No	You can choose output the error codes or not.
End of line	LF CRLF	Code to be used for end of line (depending on operating system)



## 5.6.11 Offset

Various operating conditions or measurement tasks may necessitate an offset setting on the evaluation unit HYGROPHIL® F 5673. A constant shift of the wave length over the entire operating range is then implemented for each measurement.

**N.B.:** At a gas temperature of 30°C, this shift has a linear effect on the displayed measured value within the dew-point range -40...+20 °C DT. Outside this range the offset correction has a greater effect on the displayed measured value on account of the sensor characteristic.

- Open the menu “Offset”.
- With HCDT measuring is only one channel available. Confirm the channel.

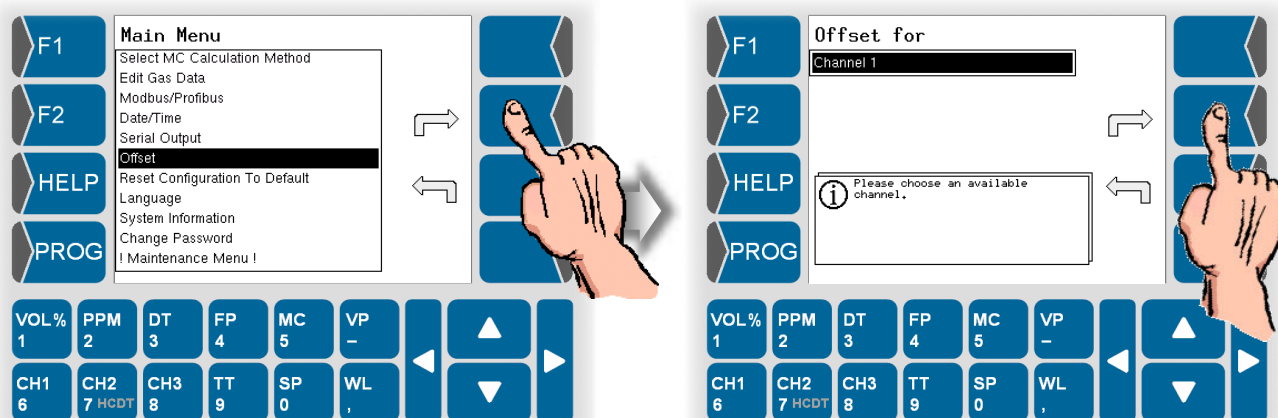

- Select whether to set the offset for DT or for PPM or if you directly want to set the wave length shift ( $\Delta$ WL Offset).

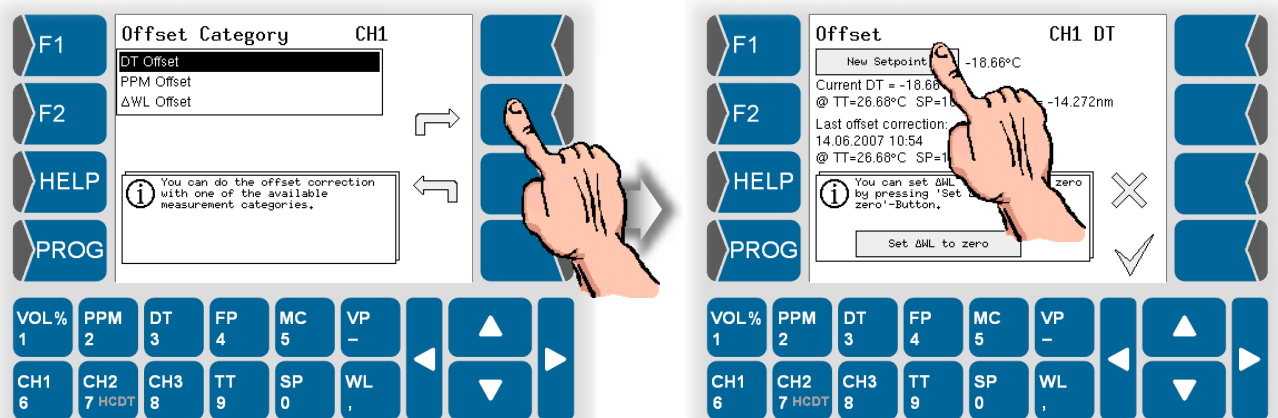

- Under “New Setpoint“ enter the externally measured reference value for the displayed value resp. the direct wave length shift. The display indicates the current measured values, the date of the last offset correction and the conditions prevailing at that time (TT and SP) as well as the wave length shift ( $\Delta$ WL).

### Cancel offset

If you want to cancel an offset setting, touch the Set  $\Delta$ WL to zero field. The wave length shift is reset to zero, consequently no offset is set any more.

## 5.6.12 Reset configuration to default

In this menu you can reset either the complete system configuration, just the database or just the HCDT control configuration to default values.

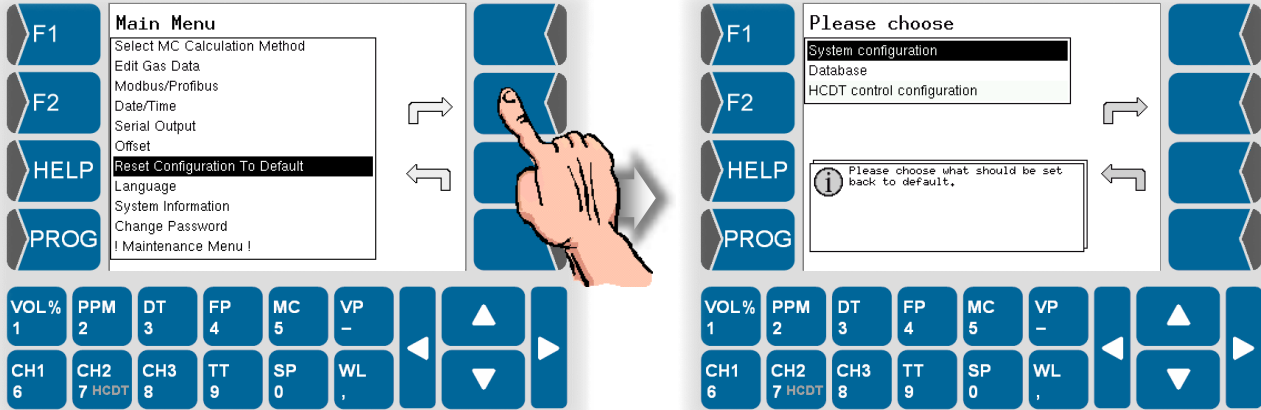

Reset system configuration may be necessary if error messages indicate that configuration files cannot be loaded.

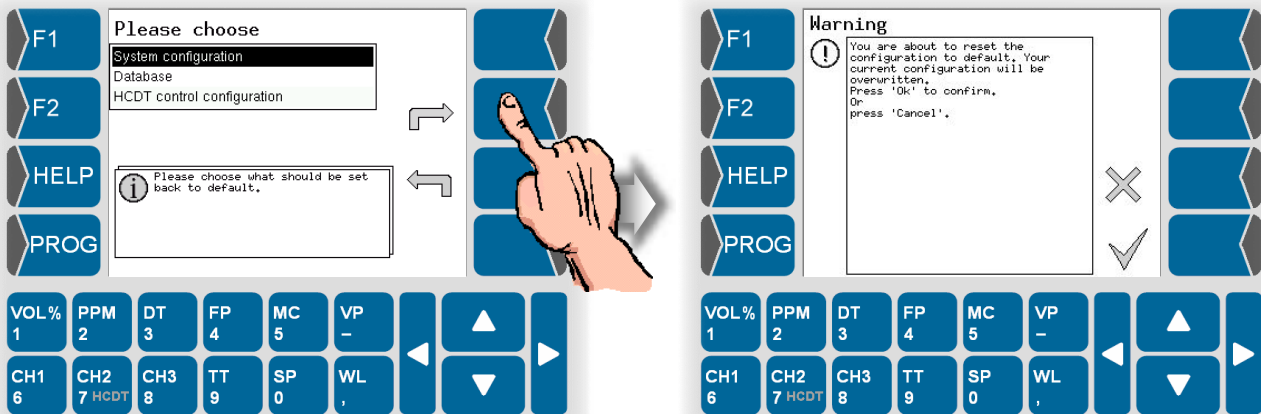

After the resetting the system configuration, you have to set all parameters in accordance with your required configuration again.

When **resetting the database** the stored measurement history will be cleared.

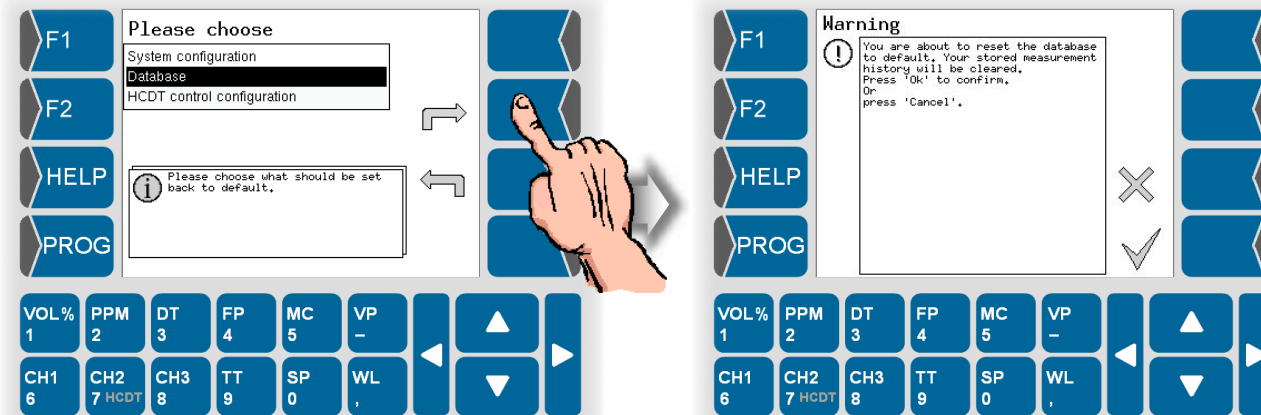

**Resetting the HCDT control configuration** is necessary after updating the software to version 1.8 or higher. From this version a different calculation method is used.

Please contact the BARTEC-BENKE service if you want to update the software.

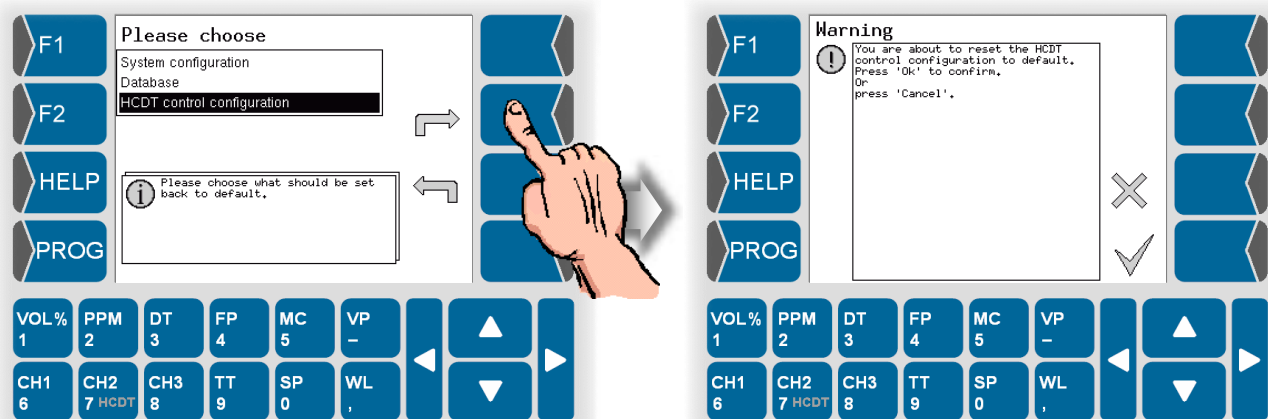

## 5.6.13 Language

- Open the Menu „Language“.
- Select the language used for all messages on the display.

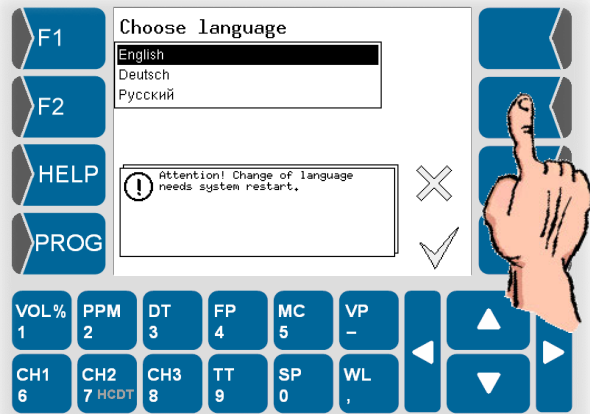
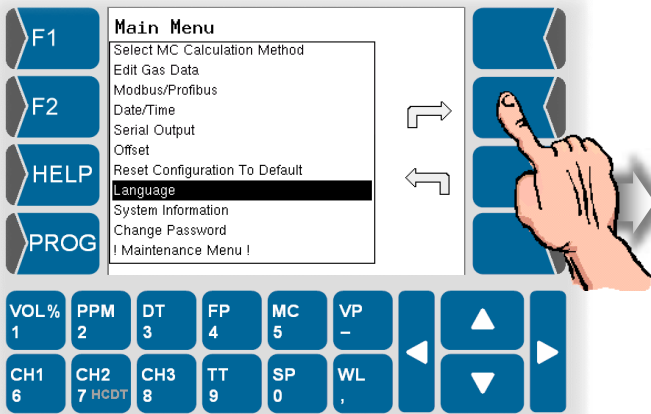

Please mind that the device will be rebooted if you save these settings. Do not implement these settings if the ongoing measurement process must not be interrupted!

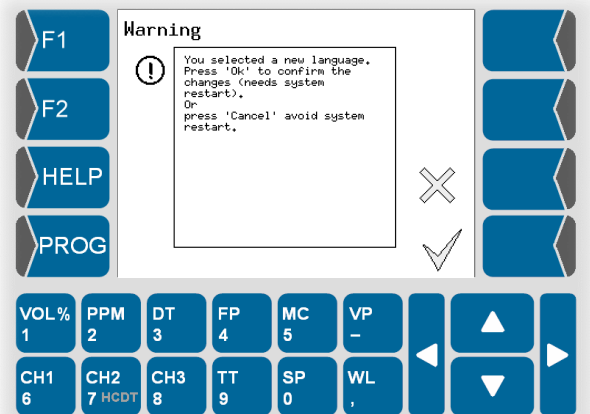

If you select another language, the operating voltage has to be applied until the device is back in the measuring operation mode. Disconnection of the voltage will cause a data loss.

This message appears during the restarting process:

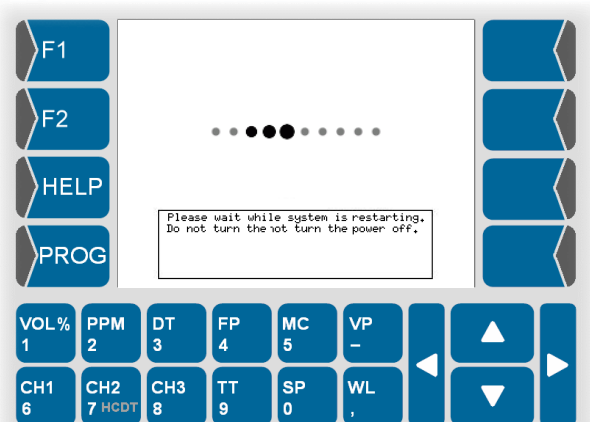

## 5.6.14 System Information

Information on the manufacturer and on the software version is displayed.

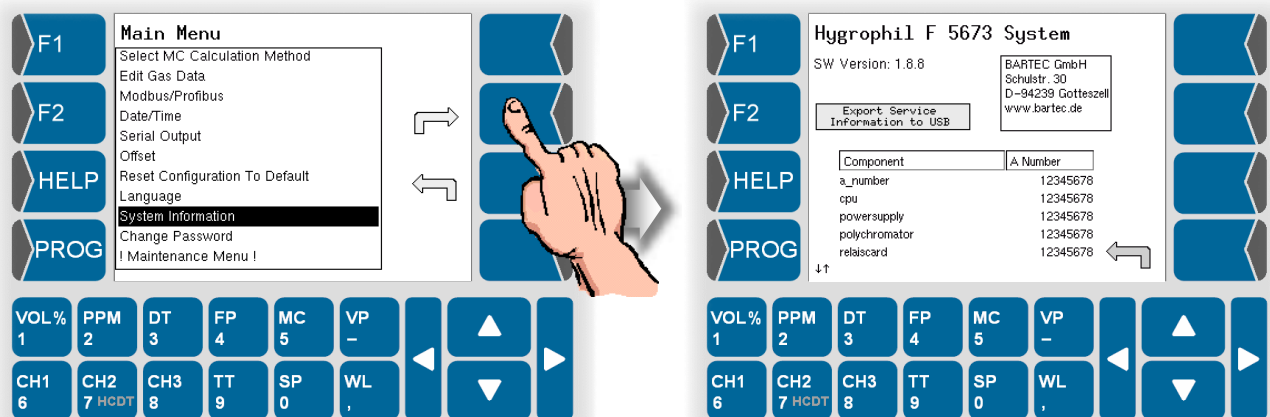

### Export service information to an external data medium

For an analysis by your service staff you can export service information via USB interface to an external data medium. Databases, logfiles and configuring information will be copied to the data medium.

- Connect the external medium (e.g. USB-stick) to the USB-port at the back of the evaluation unit.

The data medium must be FAT 32 formatted!

- Touch the button Export Service Informationen to USB.

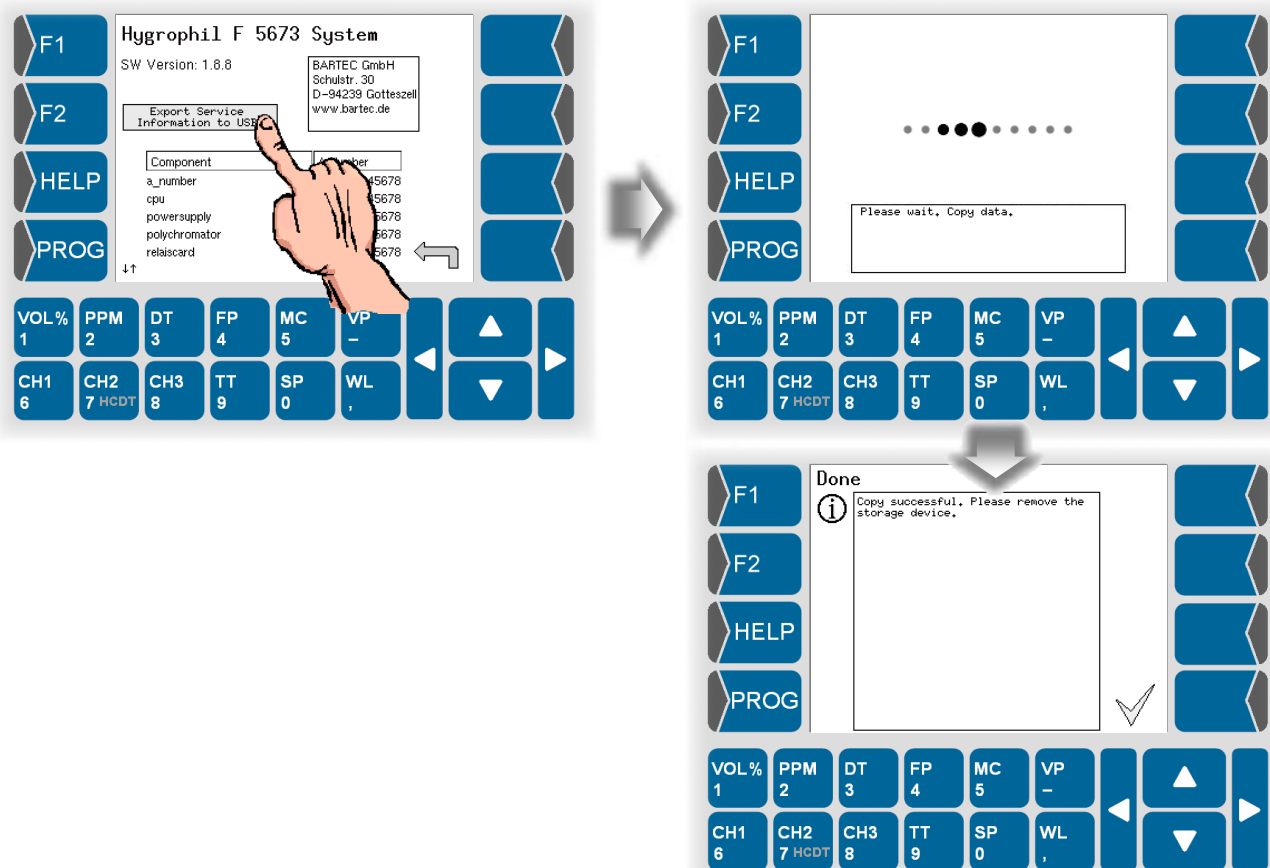

## Change Password

To call up the programming mode you must enter a password (see section 5.2). The default password is 5673. You can change the password that is set as default.

- Open the menu „Change Password“. A warning will be displayed.

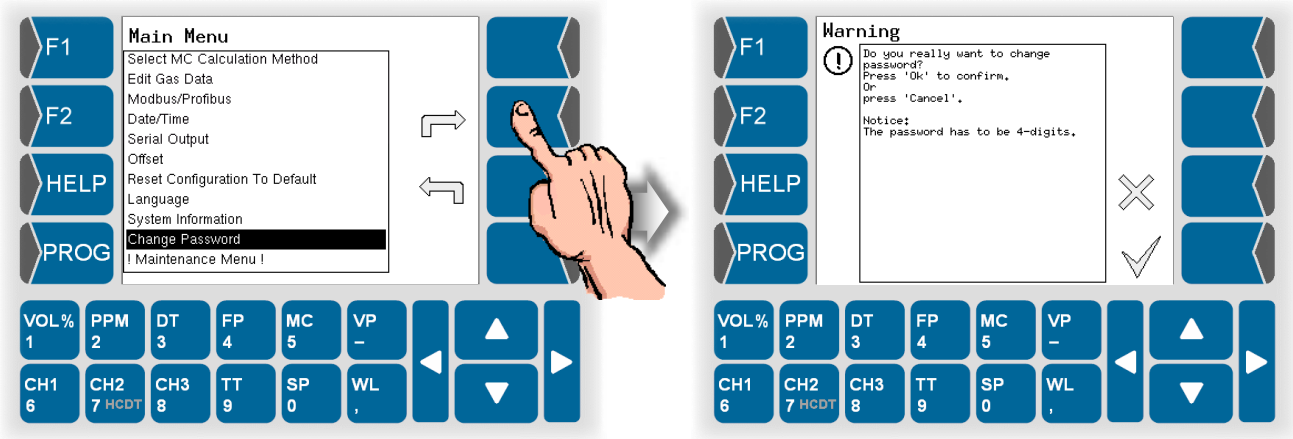

- Confirm the warning if you want to change the password.
- Enter the new password. The password must consist of four digits.

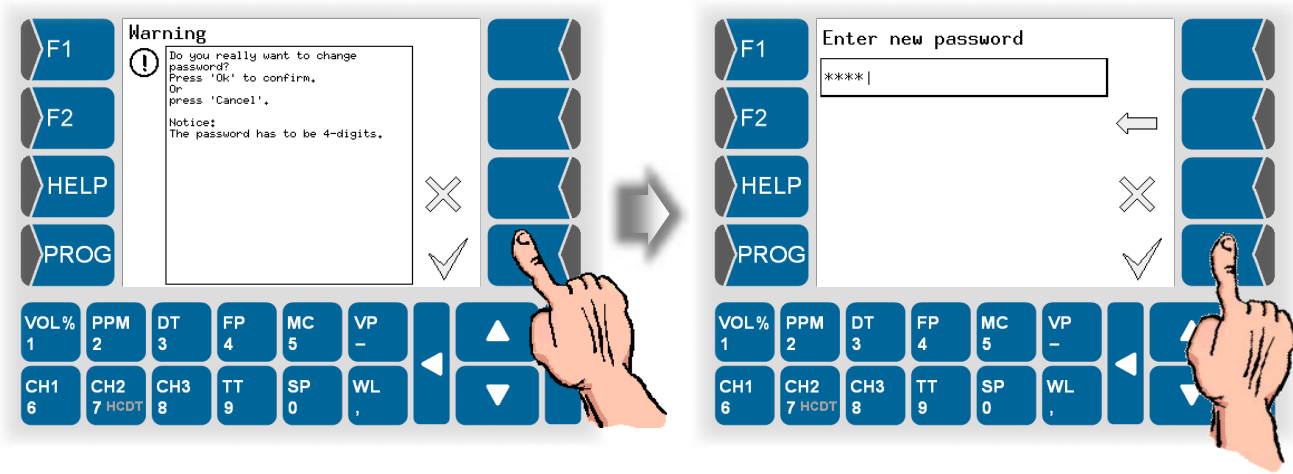

After confirming the new password it is valid immediately.

### 5.6.16 Maintenance menu

This menu is exclusively reserved for authorised service staff. The access is protected by a password.

The maintenance menu currently contains a parameter "Humidity measurement revision". This can be set to "Yes" or "No".

- "Yes": The device is serviced, the measured values are invalid.
- "No": The device is in operation, the measured values are valid.

The parameter can be read out via Modbus. The values have the following meaning:

- 0: "No"
- 1: "Yes"







## 6 Error handling

Warnings and errors as well as indications of limit transgressions are displayed in the appropriate measurement value line and in the info line in the field for the respective channel. If warnings or errors are indicated, you will get further information and instructions on error correction if you touch **HELP** (see section 6.4).

Malfunctions during the operation of HYGROPHIL® F 5673 may result from faulty plug connections. First verify that all connections (sensors, analog cards) have been correctly plugged. If there is any suspicion of defective sensors or cards, check if the problem is remedied when they are replaced.

Another possible reason for malfunctions can be electromagnetic fields. Check if there are any potential sources of interference near the device. In the case of temporary interferences, the problem can usually be remedied after a few minutes or after a restart of the device.

If you have any doubts as to the correctness of the measurement values or if there are any malfunctions which cannot be remedied with the measures indicated when you touch **HELP**, please contact the BARTEC service team. It may be necessary to send the device to the manufacturer for repair.

### 6.1 Limit transgressions

If a programmed limit value (see section 5.6.5) for a measurement variable is overshoot resp. fallen below, this is indicated by an arrow in the status display of the measurement value line and in the info line. Below the arrow there is the measurement variable whose limit has been overshoot or fallen below.

A signal is displayed at the limit output.

This is no error and no malfunction.

#### **Example**

The measured value exceeded the programmed value for the upper limit of HCDT.

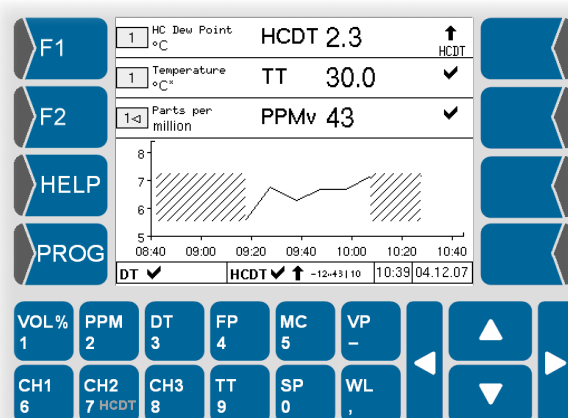

## 6.2 Warnings



**Example**

These messages indicate particularities in the measurement conditions. The measurement operation is maintained. A warning sign appears in the info line.

A temperature sensor should be used. The temperature sensor is not connected or it is defective. The programmed fixed value for temperature is used.

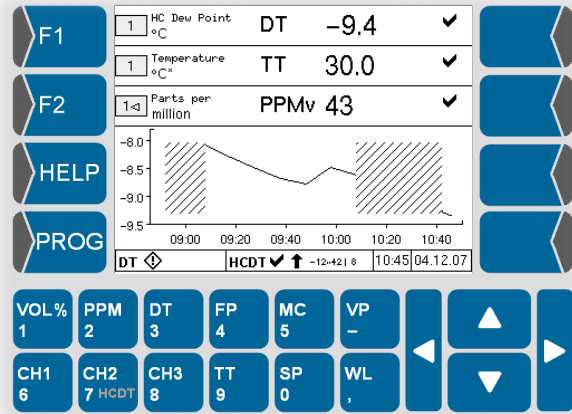

Touch **HELP** to receive further information on the warning that is displayed (see section 6.4).

## 6.3 Errors



**Example**

All errors preventing the measurement operation are indicated by an error sign in the status display and in the info line. A signal is issued at the error output. In addition, limit transgressions due to wrong or missing calculation bases can be reported.

There is a malfunction in the optical system, e.g. the fibre-optic humidity sensor is not connected or it is defective.

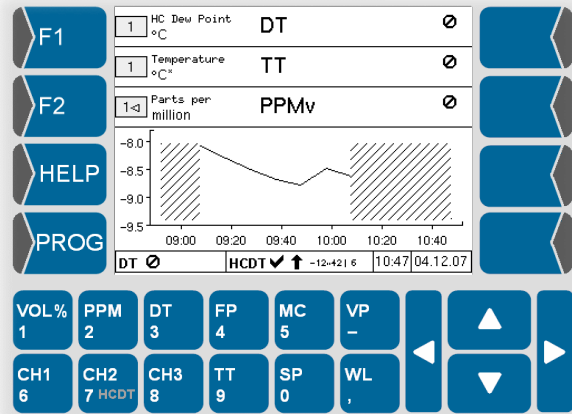

Touch **HELP** to receive further information on the error that is displayed (see section 6.4).

## 6.4 HELP-key

In the case of warnings and errors (but not for limit transgressions), touch **HELP** to receive details on the reported errors. You also get instructions on how to remedy malfunctions and errors.

If there are several errors at the same time, they are displayed in one line after another. Use **▲** and **▼** to select an error message. In the lower part of the display, the appropriate information and solution possibilities are indicated.

In the lower line on the left, the total number of currently existing errors is displayed.

On the right, the error code of the currently selected error is displayed.

The errors code unequivocally defines each error. If required, send this code to the service company.

As soon as a malfunction or an error has been remedied, the message and the corresponding info text disappear.

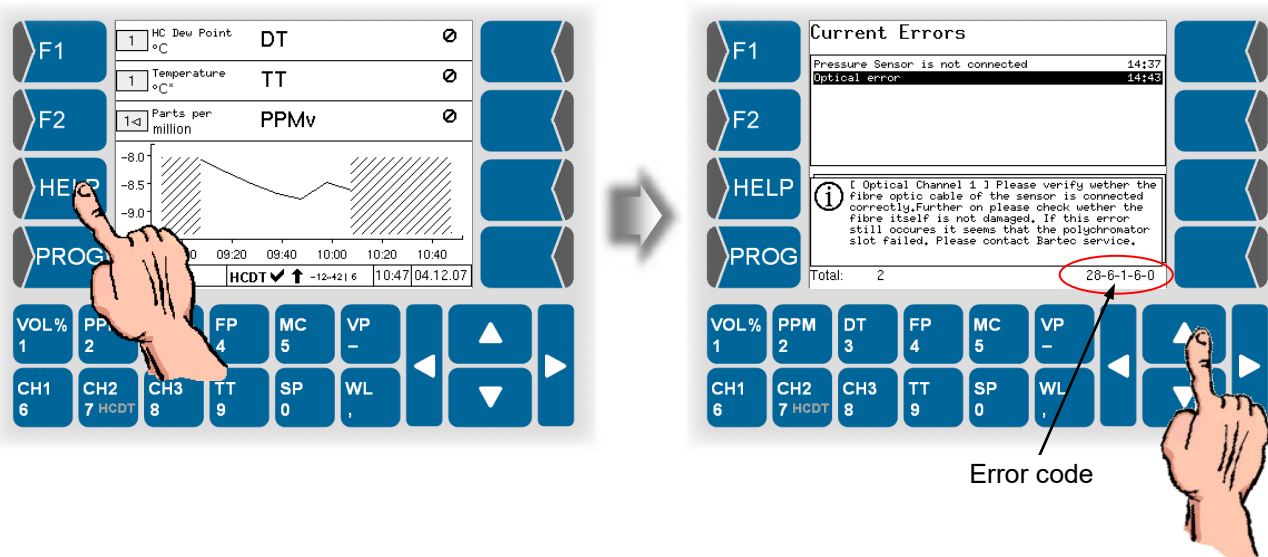



# 7 Maintenance

## Cleaning the humidity sensor

Maintenance of the HYGROPHIL® F 5673 is limited to cleaning the moisture-sensitive layer on the tip of the sensor L 166x.

The cleaning intervals depend on how dirty the sample gas is.



Handle the sensor very carefully. The moisture-sensitive layer is very susceptible to knocks and scratches. Never use pointed or sharp edged objects to clean the sensor. Damage may result in incorrect measurements.

- Take the probe out of the measuring line. <sup>(1)</sup>

Use soft cleaning cloths only.

- Clean the sensor tip with a soft cloth twisted to a tip, preferably one impregnated with alcohol (isopropyl). BARTEC BENKE recommends OpticPads CT811 supplied by CleanTex, or similar products

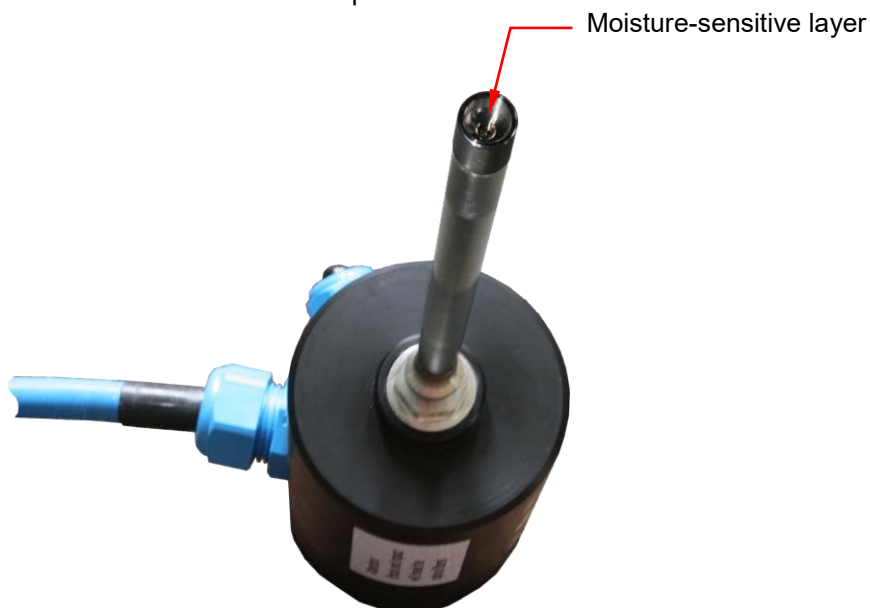

- Then wipe the surface several times with a soft cloth to remove any residues of alcohol.

Use the cloths only once!

- Reinsert the sensor in the measuring line.<sup>(1)</sup>

<sup>(1)</sup> When removing and reinserting the sensor, follow the instructions provided with the accessories used (e.g. sensor retraction tool).

If a L1660 sensor is used you can unscrew the protective cap. If you cannot undo the cap by hand, loosen it carefully with pliers.

- After cleaning the sensor tip, screw the protective cap carefully back on the sensor.

# 8 Bus systems

## 8.1 Modbus

The MODBUS data transfer of the HYGROPHIL® F 5673 uses the **RTU (Remote Terminal Unit)** mode. It is always a MODBUS slave and is physically transmitted through a RS485 connection. The RS485 line has to be connected on clamps 414(-) and 415(+).

Alternatively the MODBUS can be operated via RS232 interface. You can select the interface in the “Modbus/Profibus” menu (see section 5.6.8).

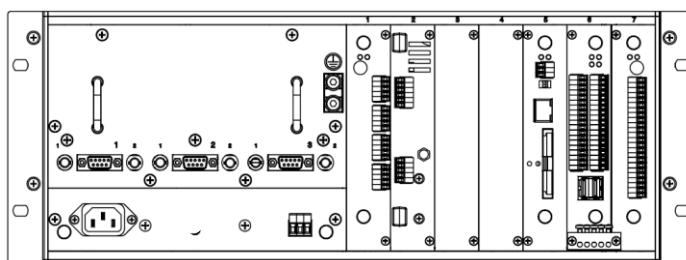

Interface module

5673-110

	Design.	Signal	Design.	Signal	
Analog Out 1 0/4-20mA	401	OUT 1+	404	OUT 2+	Analog Out 2 0/4-20mA
	402	OUT 1-	405	OUT 2-	
	403	Shield	406	Shield	
Analog Out 3 0/4-20mA	407	OUT 3+	410	free	
	408	OUT 3-	411	free	
	409	Shield	412	free	
MODBUS RTU RS485, +24V, max 50mA	413	+24V	417	+24V	RS485, +24V, max 50mA
	414	A1	418	A2	
	415	B1	419	B2	
	416	GND	420	GND	
	421	+24V	424	GND	Serial Out RS232, +24V, max 50mA
	422	RxD 1	425	TxD 1	
	423	CTS 1	426	RTS 1	
	427	+24V	430	GND	MODBUS RTU RS232, +24V, max 50mA
	428	RxD 2	431	TxD 2	
	429	CTS 2	432	RTS 2	
	433	+5V	436	GND	Profibus, +5V max 50mA
	434	PB_A	437	Shield	
	435	PB_B	438	Shield	
	USB 1		USB 2		

281686.dwg

The MODBUS slave address has a range from 1 to 247 and could be easily changed by means of the application software. On the same way the baud rate (1200, 2400, 4800, 9600, 19200, 38400, 57600, 115200) and the interface's parity (even, odd, none) can be changed (see section 5.6.8).

The HYGROPHIL® F 5673 MODBUS supports function codes „01 → Read single coils“, „03 → Read multiple holding registers“ and „08 → Diagnostics“.

Function code „01“ supplies the master system with the data listed in Table 1.

**Request Host**

Function code	1 Byte	<b>0x01</b>
Start Address	2 Bytes	<b>0 to 60</b>
Count of bits	2 Bytes	<b>1 to 61</b>

**Response HYGROPHIL® F**

Function code	1 Byte	0x01
Number of bytes	1 Byte	Number of bytes for the bit information to be transferred
Bit information	data (bitwise coded) corresponding to the specified number of bytes	

<i>Table 1</i>			
<b>01 Read Single Coils</b>			
0	CH1 Present?	30	Is Sample CO2 CH1 Valid?
1	CH2 Present?	35	Is Wavelength CH2 Valid?
2	CH3 Present?	36	Is Volume percent CH2 Valid?
3	HCDT HW Present?	37	Is PPM CH2 Valid?
4	Error Status CH1	38	Is Dew Point CH2 Valid?
5	Limit Status CH1	39	Is Frost Point CH2 Valid?
6	Liquid measurement CH1	40	Is Vapour pressure CH2 Valid?
7	Error Status CH2	41	Is Moisture content CH2 Valid?
8	Limit Status CH2	42	Is Sample Temperature CH2 Valid?
9	Liquid measurement CH2	43	Is Sample Pressure CH2 Valid?
10	Error Status CH3	44	Is Sample CO2 CH2 Valid?
11	Limit Status CH3	49	Is Wavelength CH3 Valid?
12	Liquid measurement CH3	50	Is Volume percent CH3 Valid?
13	HCDT Error	51	Is PPM CH3 Valid?
21	Is Wavelength CH1 Valid?	52	Is Dew Point CH3 Valid?
22	Is Volume percent CH1 Valid?	53	Is Frost Point CH3 Valid?
23	Is PPM CH1 Valid?	54	Is Vapour pressure CH3 Valid?
24	Is Dew Point CH1 Valid?	55	Is Moisture content CH3 Valid?
25	Is Frost Point CH1 Valid?	56	Is Sample Temperature CH3 Valid?
26	Is Vapour pressure CH1 Valid?	57	Is Sample Pressure CH3 Valid?
27	Is Moisture content CH1 Valid?	58	Is Sample CO2 CH3 Valid?
28	Is Sample Temperature CH1 Valid?	61	Is Hydro Carbon Dew Point Valid?
29	Is Sample Pressure CH1 Valid?		



**Function code „03“** answers with registers of measurement variables and parameters as showed in *Table 2*. The field 60-79 represent states and error codes. Special measurement variables need a more detailed resolution. Therefore some variables are spanned over two 16-bit registers (such values are marked with HI and LO in the 16-/32- bit column).

#### Request Host

Function code	1 byte	<b>0x03</b>
Start address	2 bytes	<b>0 to 79</b>
Number of registers	2 bytes	<b>1 to 80</b>

#### Response HYGROPHIL® F

Function code	1 byte	<b>0x03</b>
Number of bytes	1 byte	Number of transmitted registers multiplied with 2
Values of registers	Number of transmitted registers x 2 bytes	

The values in the holding registers are spread to the available range.

#### Example

A **16 bit value** has a range of values **0 ... 65535**.

Register 4, dewpoint channel 1 is between -100 °C and +100 °C.

-100 °C correlates 0 (min)

+100 °C correlates 65535 (max)

The conversion is as follows:

$$\frac{\text{Register value} * (\text{max} - \text{min})}{65535} + \text{min} = \text{value}$$

When HYGROPHIL for the dewpoint at channel 1 reports the register value 12345, results:

$$\frac{12345 * 100 - (-100)}{65535} + (-100) = \underline{\underline{62.32}} \text{ °C}$$

Conversion of **32 bit values** is analogous.

The range of values is here **0 ... 4294967295**.

03 Read Holding Registers					
Addr.	16-/32 Bit	Description	Min	Max	Unit
0		Wavelength CH1	780	830	nm
1		Volume percent CH1	0	100	%
2	HI	PPM CH1	0	25000	ppm
3	LO				
4		Dew Point CH1 (-100-100 °C or -148-212 °F)	-100	100	°C
5		Frost Point CH1 (-100-100 °C or -148-212 °F)	-100	100	°C
6	HI	Vapour pressure CH1 (0-250hPa/mbar or 0-3.626psi)	0	250	hPa/mbar
7	LO				
8	HI	Moisture content CH1 (0-30000mg/m <sup>3</sup> or 0-1873.83lb/MMScf)	0	30000	mg/m <sup>3</sup>
9	LO				
10		Sample Temperature CH1 (-50-100 °C or -58-212 °F)	-50	100	°C
11	HI	Sample Pressure CH1 (0-250000hPa/mbar or 0-3626psi)	0	250000	hPa/mbar
12	LO				
13		Sample CO <sub>2</sub> CH1	0	100	%
14	HI	RH CH1	0	100	%
15	LO				
18		Wavelength CH2	780	830	nm
19		Volume percent CH2	0	100	%
20	HI	PPM CH2	0	25000	ppm
21	LO				
22		Dew Point CH2 (-100-100 °C or -148-212 °F)	-100	100	°C
23		Frost Point CH2 (-100-100 °C or -148-212 °F)	-100	100	°C
24	HI	Vapour pressure CH2 (0-250 hPa/mbar or 0-3.626 psi)	0	250	hPa/mbar
25	LO				
26	HI	Moisture content CH2 (0-30000mg/m <sup>3</sup> or 0-1873.83lb/MMScf)	0	30000	mg/m <sup>3</sup>
27	LO				
28		Sample Temperature CH2 (-50-100 °C or -58-212 °F)	-50	100	°C
29	HI	Sample Pressure CH2 (0-250000 hPa/mbar or 0-3626 psi)	0	250000	hPa/mbar
30	LO				
31		Sample CO <sub>2</sub> CH2	0	100	%
32	HI	RH CH2	0	100	%
33	LO				

Addr.	16-/32 Bit	Description	Min	Max	Unit
36		Wavelength CH3	780	830	nm
37		Volume percent CH3	0	100	%
38	HI	PPM CH3	0	25000	ppm
39	LO				
40		Dew Point CH3 (-100-100 °C or -148-212 °F)	-100	100	°C
41		Frost Point CH3 (-100-100 °C or -148-212 °F)	-100	100	°C
42	HI	Vapour pressure CH3 (0-250 hPa/mbar or 0-3.626 psi)	0	250	hPa/mbar
43	LO				
44	HI	Moisture content CH3 (0-30000mg/m <sup>3</sup> or 0-1873.83lb/MMScf)	0	30000	mg/m <sup>3</sup>
45	LO				
46		Sample Temperature CH3 (-50-100 °C or -58-212 °F)	-50	100	°C
47	HI	Sample Pressure CH3 (0-250000 hPa/mbar or 0-3626psi)	0	250000	hPa/mbar
48	LO				
49		Sample CO <sub>2</sub> CH3	0	100	%
50	HI	RH CH3	0	100	%
51	LO				

54		Hydro Carbon Dew Point (if available. -50-30 °C or -58-86 °F)	-50	30	°C
55		HCDT Sensor current mirror temperature (if available)	-50 -58	100 212	°C °F
56		HCDT Sensor max. mirror temperature (if available)	-50 -58	100 212	°C °F
57		HCDT Sensor min. mirror temperature (if available)	-50 -58	100 212	°C °F
58		HCDT State 0=Error 1=Heat Mirror 2=Fast adjust sensor temperature 3=Seeking current HCDT	0	65535	
59		Software Version	0	65535	
60		Error 1	0	65535	
...		...	0	65535	
79		Error 20	0	65535	
80		HCDT Sensor light value (if available)	0	1000	
81		HCDT Sensor env. temperature (if available)	-50 -58	100 212	°C °F

The availability of the device can be verified using "08" (Diagnostics). Upon receiving such a request, Hygrophil F copies the request and sends it unaltered back to the host. This enables verification of the availability of the device at the channel. This corresponds to the subfunction "00 -> Return Query Data". Further "Diagnostics" subfunctions are not supported, prompting the device to respond with the error code "Illegal Function."

#### Host request

Function code	1 Byte	<b>0x08</b>
Subfunction code	2 Bytes	<b>0x0000</b>
Data	2 Bytes	<b>0x0000 bis 0xFFFF</b>

#### HYGROPHIL® F response

Function code	1 Byte	<b>0x08</b>
Subfunction code	2 Byte	<b>0x0000</b>
Data	2 Bytes	Gleich der Anfrage

## 8.2 Profibus

The Hygrophil F 5673 device supports data transfers via a certificated Profibus DP interface. All Profibus specified data are written down in the GSD file „**BARx0bc9.gsd**“. The devices slave address is on the fly changeable by both the Profibus Master and on the device itself.

The data field has a size of 122 bytes and is consistent over the whole data frame. This allows the user a detailed overview and shows the state and the measurement variables of the devices. *Table 3* shows the positions of state and measurement variables within the 122 bytes data field.

<i>Table 3 (from software version 1.8.12*)</i>								
<b>HYGROPHIL® 5673 Profibus Data Description</b>								
<b>Byte</b>	<b>Content Description</b>							
	Status Information							
<b>0</b>	<i>MSB</i>				<i>LSB</i>			
	CH1 Present	CH2 Present	CH3 Present	HCDT Present	CH1 Error	CH2 Error	CH3 Error	HCDT Error
<b>1</b>	<i>MSB</i>				<i>LSB</i>			
	CH1 Limit	CH2 Limit	CH3 Limit	HCDT Limit	CH1 LiqMeas	CH2 LiqMeas	CH3 LiqMeas	reserved
<b>2-3</b>	reserved							

Byte 0 and Byte 1 represent the status of the device.

\* To software versions less than 1.8.12 applies for bytes 0 to 3, the following constellation:

<i>Table 3 (Software versions earlier than 1.8.12)</i>								
<b>HYGROPHIL® 5673 Profibus Data Description</b>								
<b>Byte</b>	<b>Content Description</b>							
	Status Information							
<b>0-1</b>	reserved							
<b>2</b>	<i>MSB</i>				<i>LSB</i>			
	reserved	CH3 LiqMeas	CH2 LiqMeas	CH1 LiqMeas	HCDT Limit	CH3 Limit	CH2 Limit	CH1 Limit
<b>3</b>	<i>MSB</i>				<i>LSB</i>			
	HCDT Error	CH3 Error	CH2 Error	CH1 Error	HCDT Present	CH3 Present	CH2 Present	CH1 Present

Byte 2 and Byte 3 represent the status of the device.

Table 3 continued

Starting on byte 4 to byte 115 the system mirrors four-byte float values.

Channel 1 Data

<b>4-7</b>	TT	C
<b>8-11</b>	SP	hPa/mbar
<b>12-15</b>	WL	nm
<b>16-19</b>	VOL	%
<b>20-23</b>	PPM	ppm
<b>24-27</b>	DT	C
<b>28-31</b>	FP	C
<b>32-35</b>	MC	mg/m <sup>3</sup>
<b>36-39</b>	VP	hPa/mbar

Channel 2 Data

<b>40-43</b>	TT	C
<b>44-47</b>	SP	hPa/mbar
<b>48-51</b>	WL	nm
<b>52-55</b>	VOL	%
<b>56-59</b>	PPM	ppm
<b>60-63</b>	DT	C
<b>64-67</b>	FP	C
<b>68-71</b>	MC	mg/m <sup>3</sup>
<b>72-75</b>	VP	hPa/mbar

Channel 3 Data

<b>76-79</b>	TT	C
<b>80-83</b>	SP	hPa/mbar
<b>84-87</b>	WL	nm
<b>88-91</b>	VOL	%
<b>92-95</b>	PPM	ppm
<b>96-99</b>	DT	C
<b>100-103</b>	FP	C
<b>104-107</b>	MC	mg/m <sup>3</sup>
<b>108-111</b>	VP	hPa/mbar

HCDT Data

<b>112-115</b>	HCDT	C
<b>116-122</b>	reserved	

If the HYGROPHIL® F is the physically last device on the Profibus, the termination resistors on the COM board have to be activated with the onboard jumpers (see figure below).

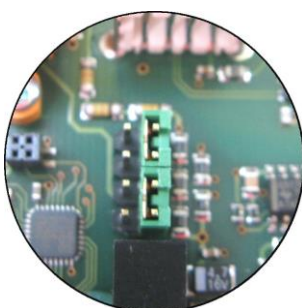
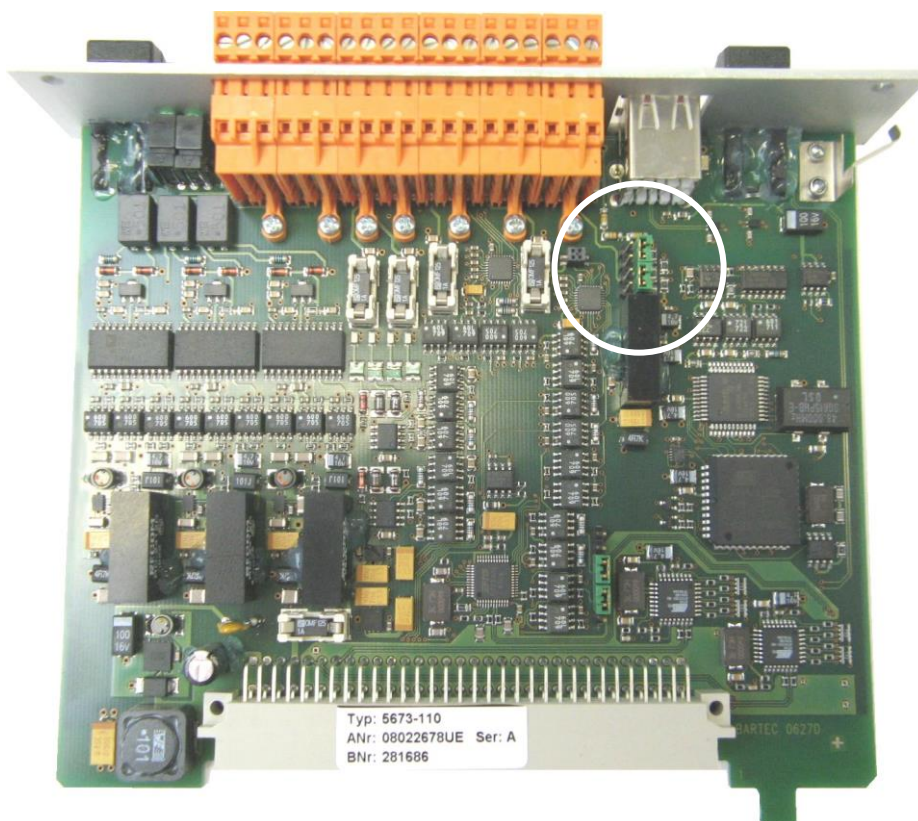

*Jumpers open,  
termination deactivated*

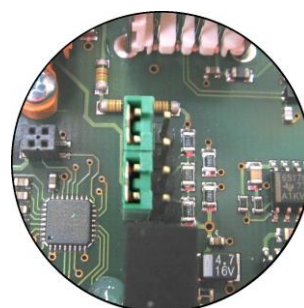

*Jumpers closed,  
termination active*

Please connect the Profibus on 434 (A), 435 (B) and 438 (shield).

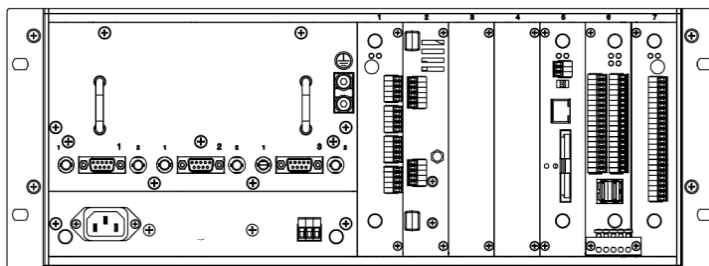

Interface module  
5673-110

	Design.	Signal	Design.	Signal	
Analog Out 1 0/4-20mA	401	OUT 1+	404	OUT 2+	Analog Out 2 0/4-20mA
	402	OUT 1-	405	OUT 2-	
	403	Shield	406	Shield	
Analog Out 3 0/4-20mA	407	OUT 3+	410	free	RS485, +24V, max 50mA
	408	OUT 3-	411	free	
	409	Shield	412	free	
MODBUS RTU RS485, +24V, max 50mA	413	+24V	417	+24V	Serial Out RS232, +24V, max 50mA
	414	A1	418	A2	
	415	B1	419	B2	
	416	GND	420	GND	
MODBUS RTU RS232, +24V, max 50mA	421	+24V	424	GND	Profibus, +5V max 50mA
	422	RxD 1	425	TxD 1	
	423	CTS 1	426	RTS 1	
	427	+24V	430	GND	
	428	RxD 2	431	TxD 2	
	429	CTS 2	432	RTS 2	
	433	+5V	436	GND	
	434	PB_A	437	Shield	
	435	PB_B	438	Shield	

USB 1	USB 2
-------	-------

281686.dwg

## 8.3 Modbus TCP/IP

The Modbus TCP/IP data transmission is via an Ethernet connection. The device is always in Modbus slave mode. The pin assignment of the 8P8C connector is shown in the following table.

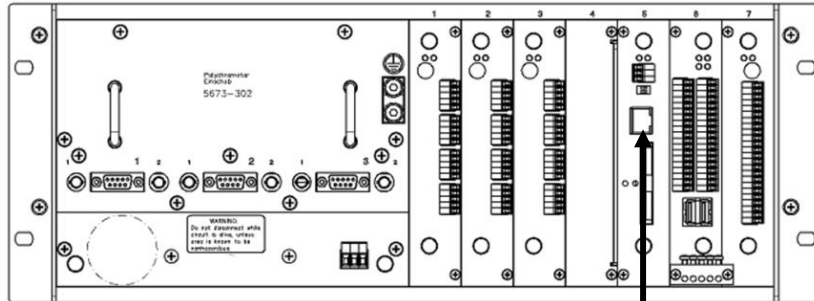

Pin assignment	
Pin 1	Tx+
Pin 2	Tx-
Pin 3	Rx+
Pin 6	Rx-

The IP address of the HYGROPHIL® F 5673 can be easily changed in the “Network settings” menu.

MODBUS TCP/IP is available from software version 1.8.43 or higher. If a version older than 1.8.43 is installed in your device, please contact the BARTEC BENKE customer service.

The MODBUS implementation only supports the function code “03 → Read holding registers 4xxxx”.

### Description of the HYGROPHIL® 5673 MODBUS TCP/IP data:

Format: 32Bit IEEE 754 floating point big-Endian

Address	Type	Description	Unit
9000	float	Process temperature (TT) CH1	°C
9001			
9002	float	Process temperature (TT) CH2	°C
9003			
9004	float	Process temperature (TT) CH3	°C
9005			
9006	float	Process pressure (SP) CH1	bar
9007			
9008	float	Process pressure (SP) CH2	bar
9009			
9010	float	Process pressure (SP) CH3	bar
9011			
9012	float	Dew point (DT) CH1	°C
9013			
9014	float	Dew point (DT) CH2	°C



Address	Type	Description	Unit
9015			
9016	float	Dew point (DT) CH3	°C
9017			
9018	float	Moisture content (MC) CH1	mg/m <sup>3</sup>
9019			
9020	float	Moisture content (MC) CH2	mg/m <sup>3</sup>
9021			
9022	float	Moisture content (MC) CH3	mg/m <sup>3</sup>
9023			
9024	float	HCDT - hydrocarbon dew point (if available)	°C
9025			
9026	float	Pressure setting cricondenthem point	bar
9027			
9028	float	HCDT sensor max. mirror temperature (if available)	°C
9029			
9030	float	HCDT sensor min. mirror temperature (if available)	°C
9031			
9072	unsigned short	Bit string 1-16	
		1) Channel 1 active? (0: no / 1: yes)	
		2) Channel 2 active? (0: no / 1: yes)	
		3) Channel 3 active? (0: no / 1: yes)	
		4) n/a	
		5) Is HCDT mode active? (0: no / 1: yes)	
		6) Error/warning channel 1 (0: no / 1: Error/warning)	
		7) Error/warning channel 2 (0: no / 1: Error/warning)	
		8) Error/warning channel 3 (0: no / 1: Error/warning)	
		9) HCDT error/warning (0: no / 1: Error/Warning)	
		10) Limit dew point channel 1 (0: no / 1: Limit exceeded)	
		11) Limit dew point channel 2 (0: no / 1: Limit exceeded)	
		12) Limit dew point channel 3 (0: no / 1: Limit exceeded)	
		13) Limit HCDT (0: no / 1: Limit exceeded)	
		14) n/a	
		15) HCDT status (0: Heating / 1: Cooling)	
		16) Is HCDT valid? (0: no / 1: yes)	
9074	float	Wavelength (WL) CH1	nm
9075			
9076	float	Wavelength (WL) CH2	nm
9077			
9078	float	Wavelength (WL) CH3	nm
9079			
9080	float	Relative humidity (RH) CH1	%
9081			
9082	float	Relative humidity (RH) CH2	%
9083			
9084	float	Relative humidity (RH) CH3	%
9085			
9086	float	Volume percent (VOL%) CH1	%
9087			
9088	float	Volume percent (VOL%) CH2	%
9089			
9090	float	Volume percent (VOL%) CH3	%
9091			

Address	Type	Description	Unit
9092	float	Parts per million (PPM) CH1	ppm
9093			
9094	float	Parts per million (PPM) CH2	ppm
9095			
9096	float	Parts per million (PPM) CH3	ppm
9097			
9098	float	Frost point (FP) CH1	°C
9099			
9100	float	Frost point (FP) CH2	°C
9101			
9102	float	Frost point (FP) CH3	°C
9103			
9104	float	Vapor pressure (VP) CH1	bar
9105			
9106	float	Vapor pressure (VP) CH2	bar
9107			
9108	float	Vapor pressure (VP) CH3	bar
9109			
9110	float	CO <sub>2</sub> content CH1	%
9111			
9112	float	CO <sub>2</sub> content CH2	%
9113			
9114	float	CO <sub>2</sub> content CH3	%
9115			
9116	float	HCDT sensor current mirror temperature (if available)	°C
9117			
9118	float	Software version (e.g. 1843 → version 1.8.43)	
9119			
9160	float	HCDT sensor light value	
9161			
9162	float	HCDT sensor ambient temperature	°C
9163			





# 9 Appendix

## List of resistance and side effects for glassfiber sensor L166x

*This list only gives general recommendations. At definite applications this has to be confirmed by tests.*

*This list is not subject of liabilities.*

Medium <i>medium</i>		Beständig <i>resistant</i>	Bemerkung <i>remarks</i>
Acetylen <i>acetylene</i>	G	+	
Alkohole <i>alcohols, generally</i>	F	+	Ex, aufgrund der Wasserstoffbrückenbindung der OH-Gruppen muss der Alkohol erhitzt werden, um die Wassermoleküle freizusetzen <i>Because of the hydrogen bonds you have to heat up the fluid to set free the water molecules</i>
Ammoniak NH <sub>3</sub> <i>ammonia</i>	G	X	Verhält sich wie Wasserdampf, daher Messung kaum möglich. <i>Acts like water vapour to the sensor, hence measurement almost impossible.</i>
Argon	G	+	
Äthanol <i>ethyl alcohol</i>	F	+	
Benzol <i>benzene</i>	F	+	
Blausäure HCN <i>hydrogen cyanide</i>	G	x	Ätzt das Glassubstrat des Sensors an <i>Attacks the glass substrate</i>
Chlor <i>chlorine</i>	G	?	Tests sind im Gange <i>Tests are in progress</i>
Di-Chlor-Ethan <i>ethylene dichloride</i>	G	+	
Druckluft <i>compressed air</i>	G	+	
Erdgas <i>natural gas</i>	G	+	Ex; auch bei Glykol-Belastung <i>Even when glycol is present</i>
Ester <i>ester</i>	F	+	
Flüssigkeiten <i>liquids, generally</i>	F	+	Messung generell gut möglich, Sonderkalibrierung erforderlich <i>measurement generally possible, special calibration necessary.</i>
Flußsäure H <i>hydrofluoric acid</i>	G	x	ätzt die SiO-Schicht an <i>will seriously etch the layer</i>
Helium	G	+	
Hexan <i>hexane</i>	G F	+	Ex
Kerosin <i>kerosene</i>	F	+	Mit Sonderkalibrierung möglich <i>With special calibration possible</i>
Kohlendioxid CO <sub>2</sub> <i>carbon dioxide</i>	G	+	Mit Sonderkalibrierung möglich <i>With special calibration possible</i>
Kohlenmonoxid CO <i>carbon monoxide</i>	G	?	
Kohlenwasserstoffe <i>hydrocarbons, generally</i>	F G	+	Messung generell gut möglich, Sonderkalibrierung erforderlich <i>Measurement generally possible, special calibration necessary.</i>
Krypton	G	+	
Lachgas <i>Nitrous oxide</i>	G	+	Ex
Methan <i>methane</i>	G	+	Ex
Methanol <i>methyl alcohol</i>	F	+	Ex,
Methylenchlorid <i>methyl chloride</i>	G	+	
Naphtha <i>naphtha</i>	G	+	
Narkosegas <i>narcotic gas</i>	G	+	möglicherweise außerhalb Messbereich <i>possibly outside measuring range</i>

Medium <i>medium</i>		Beständig <i>resistant</i>	Bemerkung <i>remarks</i>
Neon	G	+	
Nonylalkohol <i>nonanol / INA</i>	G	+	
Propan <i>propane</i>	F	+	Ex
Raffineriegas <i>refinery gas</i>	G F	+	
Recyclegas <i>recycle gas</i>	F	+	
Sauerstoff <i>oxygen</i>	G	+	
Schwefelhexafluorid SF6 <i>sulphur hexafluoride</i>	G	+	Aber: Verunreinigungen können SiO-Schicht ätzen <i>Warning: pollutants may etch the measuring layer</i>
Schwefelwasserstoff <i>hydrogen sulphide</i>	G	+	Getestet bis zu einem Anteil von 18 Vol% H2S <i>corrosive at high humidity</i>
SF4 <i>sulphur tetrafluoride</i>	G	X	bildet mit Restfeuchte HF! Ätzt sofort Sensorschicht <i>With water vapour forms hydrofluoric acid</i>
Stickoxid <i>nitric oxide</i>	G	+	
Stickstoff <i>nitrogen</i>	G	+	
Toluol <i>toluene</i>	F	+	Restfeuchte in flüssigem Lösungsmittel <i>Trace humidity in liquid solvent</i>
Vinylacetat <i>vinyl acetate</i>	F	+	Restfeuchte in flüssigem Lösungsmittel <i>Trace humidity in liquid solvent</i>
Wasserstoff <i>hydrogen</i>	G	+	Ex
Xenon	G	+	
Xylol	F	?	Tests sind im Gange <i>Tests are in progress</i>
Weitere Gase und Flüssigkeiten werden laufend getestet. Fragen Sie bitte an. <i>Further gases and liquids currently under testing. Please ask.</i>			

F	Flüssigkeit	<i>liquid</i>
G	Gas	<i>gas</i>
+	beständig	<i>resistant</i>
0	bedingt beständig	<i>partly resistant</i>
n	nicht beständig	<i>not resistant</i>
X	Quereffekte vorhanden	<i>possible side effects</i>
?	Tests nötig	<i>tests to be made</i>

### Predefined gases in HYGROPHIL® F 5673

Components			1	2	3	4	5
			Russian H Gas	North Sea I H Gas	North Sea II H Gas	Netherland I L Gas	Netherland II L Gas
Designation of the predefined gas							
Methan	CH <sub>4</sub>	mol%	98.3	88.6	83.0	81.3	82.9
Ethan	C <sub>2</sub> H <sub>6</sub>	mol%	0.5	8.4	11.6	2.8	3.7
Nitrogen	N <sub>2</sub>	mol%	0.8	0.6	1.5	14.2	11.1
Carbon dioxide	CO <sub>2</sub>	mol%	0.1	0	0.3	1.0	1.3
Propan	C <sub>3</sub> H <sub>8</sub>	mol%	0.2	1.7	3.1	0.4	0.7
2-Methylpropan	i-C <sub>4</sub> H <sub>10</sub>	mol%	0	0	0	0	0
n-Butan	n-C <sub>4</sub> H <sub>10</sub>	mol%	0.1	0.7	0.5	0.3	0.3
2,2-Dimethylpropan	neo-C <sub>5</sub> H <sub>12</sub>	mol%	0	0	0	0	0
2-Methylbutan	i-C <sub>5</sub> H <sub>12</sub>	mol%	0	0	0	0	0
n-Pentan	n-C <sub>5</sub> H <sub>12</sub>	mol%	0	0	0	0	0
n-Hexan	C <sub>6</sub> H <sub>14</sub>	mol%	0	0	0	0	0

Source: Worksheet G 260 of DVGW (Deutsche Vereinigung des Gas- und Wasserfaches e.V.).

# 10 Add-on

## 10.1 New parameter: Temperature compensation

This add-on describes a new parameter *TK...* in the configuration menu. The new parameter can be used to compensate for influences by changing the process temperature to the measuring layer and thus to the measured value. The following describes how to set the parameter.

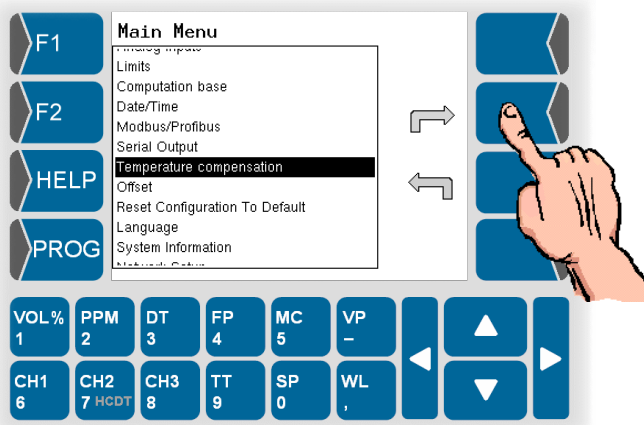

- Open the “Temperature compensation” menu in the main menu.

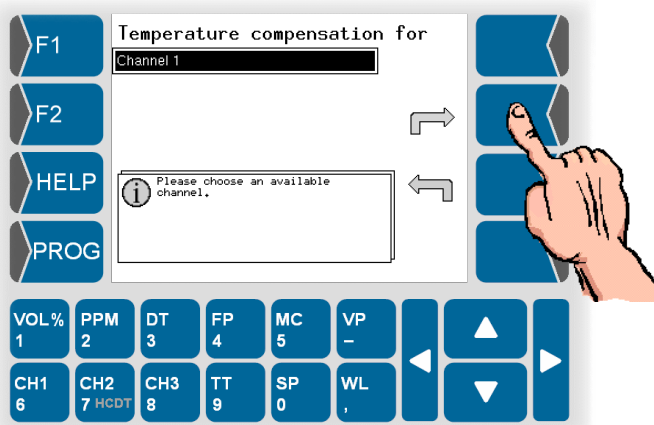

- Select the desired channel.



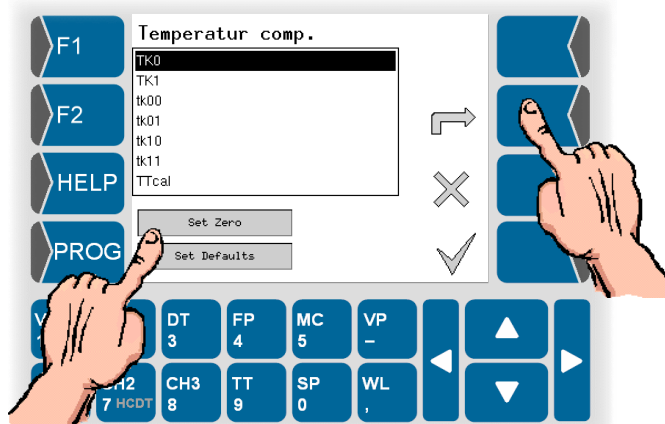

When the device is delivered, all parameters are preset to default values. The standard values should only be changed in consultation with the manufacturer.

- For type L1661 sensors with part number < 15000 and for test or calibration tasks at process temperature (TT) = 30 °C, set all parameters to the value 0. A warning message is displayed:

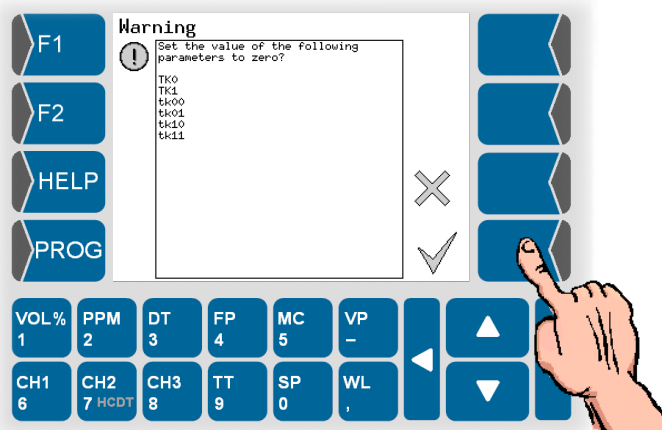

- Confirm the note if you want to set all parameters to 0. Otherwise tap on the "X".

- For measurement tasks in normal operation, reset all parameters to their default values.

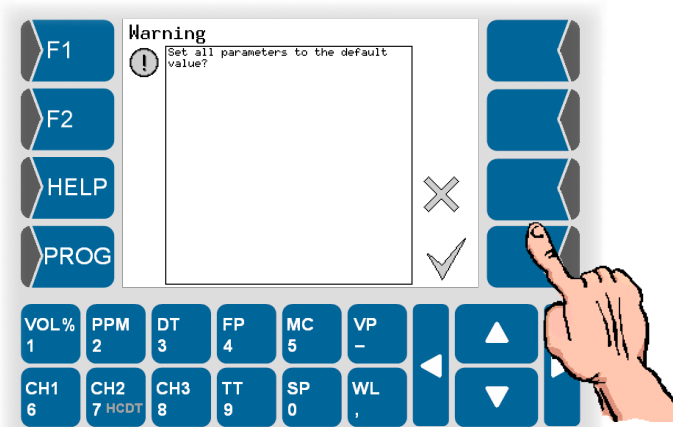

- Confirm the note if you want to reset all parameters to default. Otherwise tap on the "X".

## 10.2 Conversion of measured dew point

To convert the measured dew point DT to a dew point (“DT”) to a reference pressure, this reference pressure (SP2) must be entered for each measuring channel.

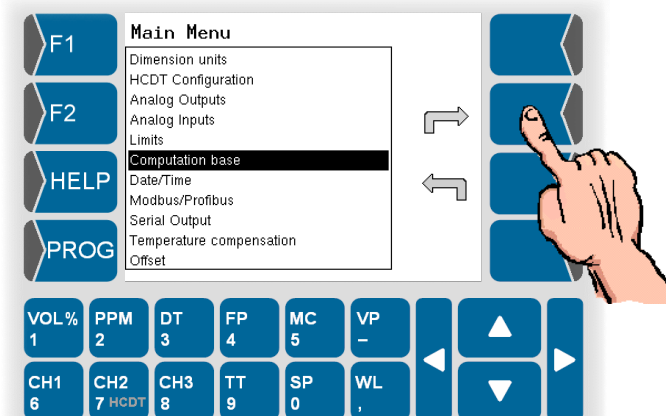

- Select “Computation base” from the main menu.

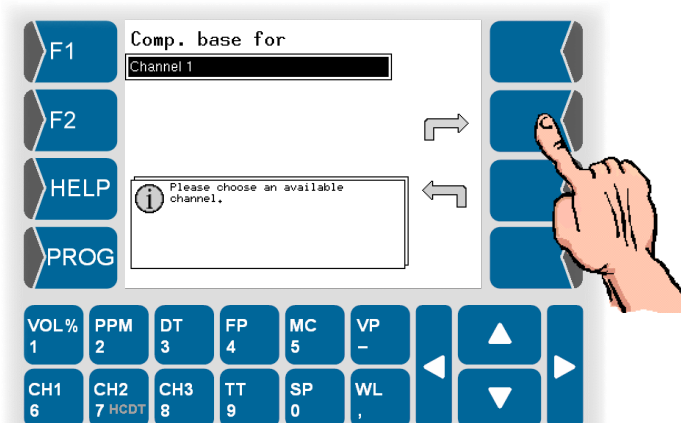

- Select the desired channel.

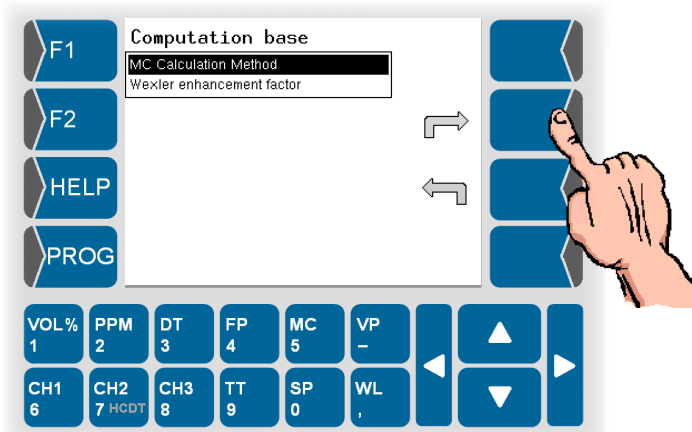

- Select the “MC Calculation Method” menu item.

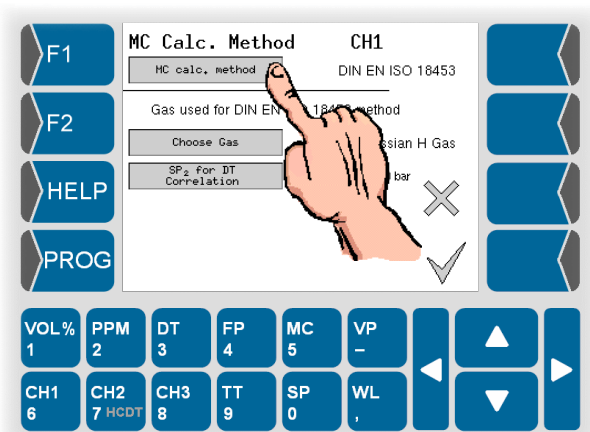

- Press the “MC calc. method” button.

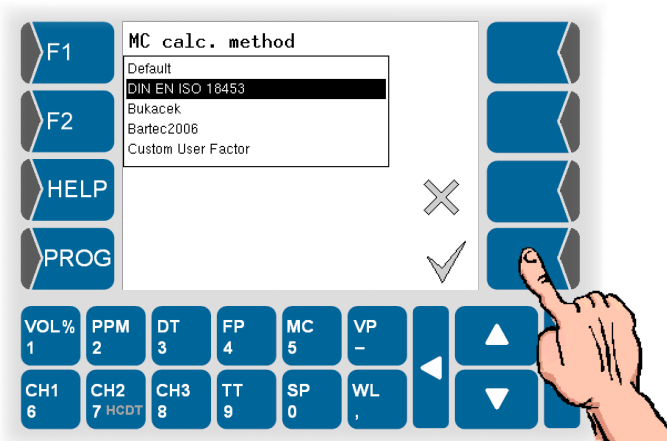

- Select the entry “DIN EN ISO 18453” using the arrow keys and confirm your selection.

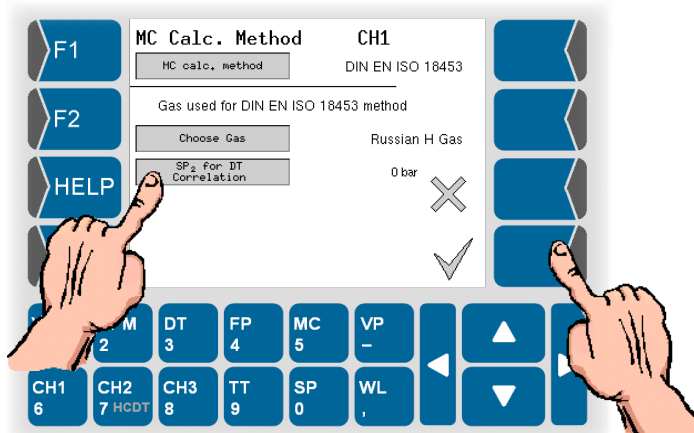

- Press the “SP2 for DT Correlation” button.
- On delivery, the value “0” is preset and the function is inactive. Enter the desired reference pressure and confirm your selection.
- Confirm the selection of the calculation method.

- If necessary, repeat the steps with each additional measuring channel.

If the reference pressure is set, all measured values in the channel display field are marked with " to indicate the set mode "DT at reference pressure".

**Caution!**

For data transmission via analog and serial interfaces as well as via Modbus, only the measured variables at reference pressure are transmitted. Due to a lack of marking, it is not clear here whether the values are reference or process pressure values.

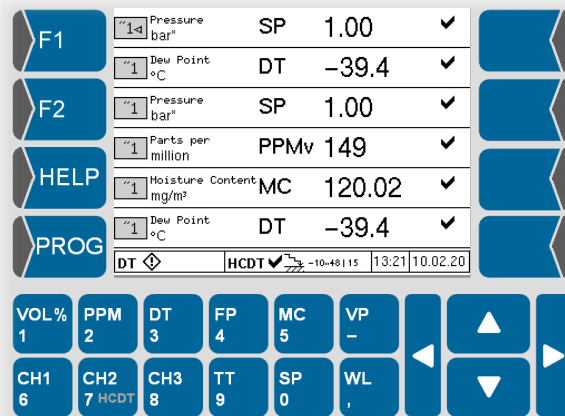

## 10.3 Shaft temperature tracking

The original operation of the HCDT sensor uses pre-cooling to hold the shaft at a constant temperature of 10 °C. This means that a measuring range for the hydrocarbon dew point temperature (HCDT) of -20 °C to 5 °C is possible (standard measuring range). Similarly, due to the constant shaft temperature, a bake-out temperature of max. 35 °C is possible before the next measuring cycle during cleaning, (see Section 1.4.11 "HCDT sensor type 1510-11" on page 1-21).

Condensates, which form at higher HCDTs are difficult to volatilize, requiring a higher temperature during bake-out in order to be able to evaporate again.

Furthermore, for some applications, it is useful to be able to safely verify the HCDT above +5 °C as well as below -20 °C.

The function of shaft temperature tracking allows for this by adjusting the shaft temperature to different levels, depending on the currently measured HCDT. For this purpose, two different shaft temperature levels (N1 and N2) as well as two different switch thresholds (S1 and S2) are defined as follows.

The following illustration shows an example of the automatic adjustment of the shaft temperature as a function of the HCDT to be measured:

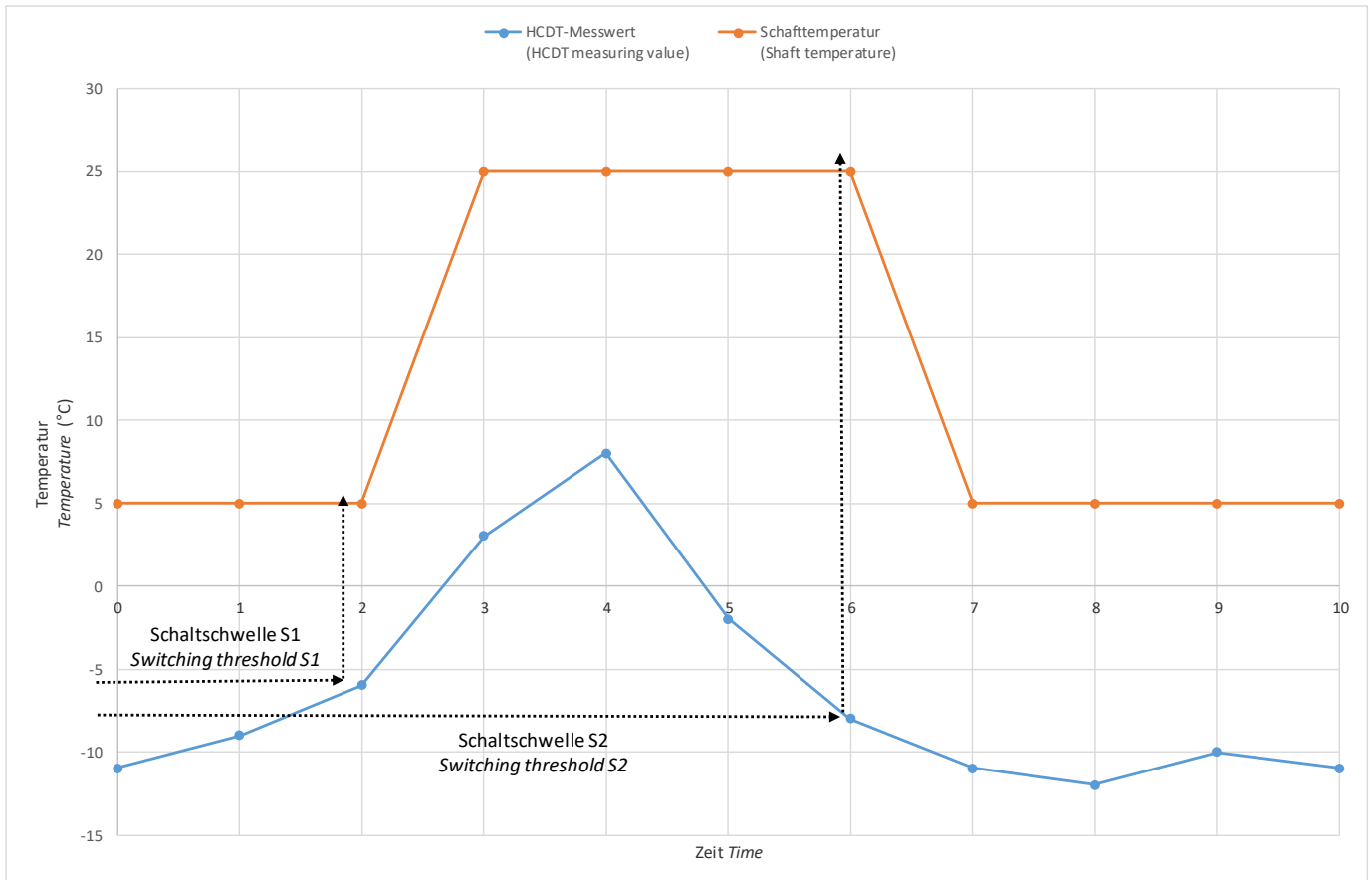

If the measured value of the HCDT exceeds the switching threshold S1, the system switches to the higher measuring range. The measurement is not continued until the shaft has reached this upper temperature level (N2).

If the HCDT falls below the switching threshold S2, the system switches to the lower measuring range. The measurement is not continued until the shaft has reached this lower temperature level (N1).

Switching the shaft temperature not only allows for more measuring range but also more possibilities for baking out the sensor at higher temperatures.

The following illustration shows an example of how the measuring range is extended with activated shaft temperature tracking and which bake-out temperatures are possible:

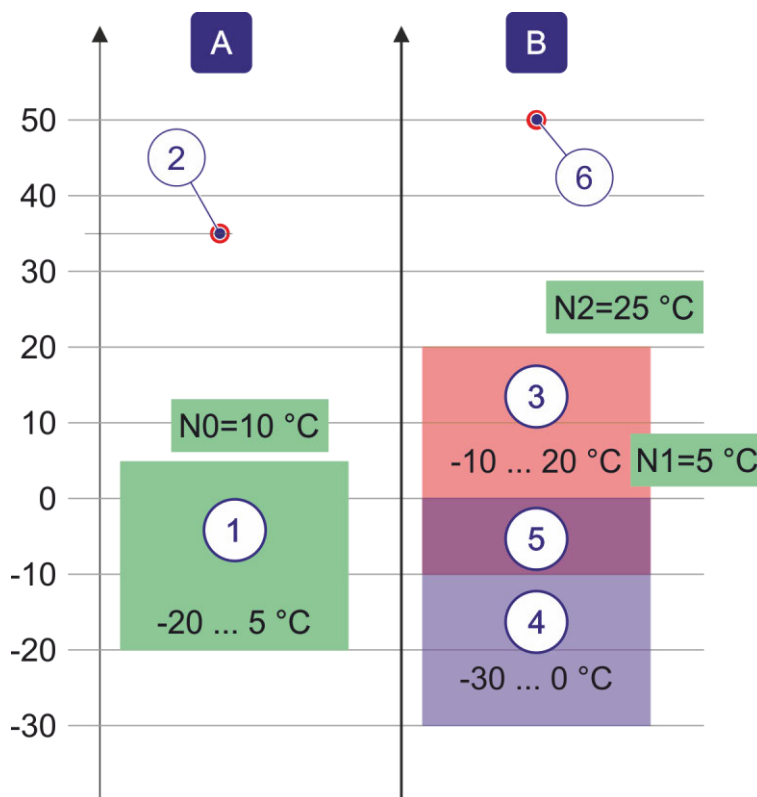

<b>A</b>	<p><b>Original operation:</b> Without shaft temperature tracking, the shaft temperature (N0) is set by default to 10 °C. The measuring range <b>(1)</b> for HCDT is between 20 and 5 °C. The maximum heating temperature <b>(2)</b> of the sensor surface is 35 °C.</p>
<b>B</b>	<p><b>Operation with shaft temperature tracking:</b> When shaft temperature tracking is activated, the upper shaft temperature level (N2) is set to 25 °C, which results in a measuring range <b>(3)</b> for HCDT of 10 to 20 °C. The lower shaft temperature level (N1) is set to 5 °C, which results in a measuring range <b>(4)</b> for HCDT of -30 to 0 °C. Both measuring ranges overlap at -10 to 0 °C <b>(5)</b>, so that, in this range, measurements are possible with both shaft temperatures.  The measuring range for HCDT has now been extended to -30 to 20 °C in total, and a bake-out temperature <b>(6)</b> of the sensor surface of 50 °C is now possible.</p>

The shaft temperature tracking function can be activated at the request of the customer. The required parameters are preset at the factory and cannot be edited by the customer.



## 10.4 New MC calculation methods

Change to Chapter 5.6.6 “Selecting the MC Calculation Method” on page 5-20:

The MC calculation methods *DIN1343* and *ISO2533* were summarized as well as *Default*. The configuration values 0 and 1 for the MC calculation methods are now used for the same calculation type *Default*.

All other configuration values remain the same. This prevents an undesired automatic change to the MC calculation methods during a software update.

### 10.4.1 Application specific factor

You can define an additional application specific factor for the following calculation methods:

- Bartec 2006
- Bukacek
- Customized factor

This factor serves for adjusting the MC/PPMV calculation. The factor can be between 0.50 and 2.00. Default is 1.0.

Enter the factor as followed:

