

1. Definition

PROFIBUS couplers and PROFIBUS repeaters are used for the separation or generation of new segments. Devices are available for PROFIBUS-DP and for PROFIBUS-IS (intrinsically safe).



Features

- PROFIBUS Coupler: signal level refresh
- PROFIBUS Repeater: signal level and time flow refresh
- Galvanically isolated bus segments for PROFIBUS-DP and PROFIBUS-IS.
- Availability of couplers for PROFIBUS-DP as well as for PROFIBUS-IS (intrinsically safe).

Safety concept

The PROFIBUS coupler and PROFIBUS repeater can be easily snapped onto a mounting rail.

To ensure explosion protection, the following measures were implemented for the devices.

The electronics are protected by a flameproof clip-on enclosure. Additional protection is provided by terminals with increased safety, intrinsically safe outputs for the "i" version and the installation in a control cabinet with protection class of at least IP 54.

The operator of the system is responsible for planning, installation, commissioning, operation and maintenance, in particular in the context of applications in hazardous areas.

The functions of the module are:

- Separation of bus segments and generation of new segments.
- Creation of complex networks in line, star, tree structures.
- PROFIBUS-conforming regeneration of the bus signals in amplitude and time.
- Increase in the number of stations.
- Segment cascading to increase the range.
- Provision of intrinsically safe bus segments for EEx i version in accordance with PROFIBUS-IS.

Intended Use

Die PROFIBUS Coupler und PROFIBUS Repeater are designed to meet the industrial requirements in hazardous (potentially explosive) areas

Industrial Requirements of Zone 1

The modules are approved as "Ex d flameproof enclosures" with connecting terminals in "Ex e increased safety ex e". Since the open connecting terminals are Ex e, the modules are given a partial certificate with the "U" marking.

Special note concerning the "U" marking







The modules must be installed in an enclosure that meets the requirements of a recognised type of protection in accordance EN/IEC 60079-0, min. protection type IP54. When installing in an enclosure with "increased safety 'e'", the clearance and creep age distances in Tables 1+2 in IEC/EN 60079-7 must be complied with.

Co-applicable documents

- Declaration of EU conformity
- Test certificates

The retention of these documents is mandatory!

2. Explosion protection and approvals

| | |
|---|--|
| ATEX | |
| Modex Type 07-7311-..../.... | |
| Test certificate | PTB 97 ATEX 1068 U |
| Ex protection type |  II 2(1) G Ex db e [ia Ga] IIC bzw. IIB Gb  II 2 G Ex db e [ib] IIC bzw. IIB Gb  I M2 Ex db e [ia Ma bzw ib] I Mb |
| Standards In accordance with Directive 2014/34/EU | EN 60079-0:2012 EN 60079-1:2014 EN 60079-7:2007 EN 60079-11:2012 |
| Ambient temperature | -25 °C bis +60 °C bei T4 |
|  Special conditions <ol style="list-style-type: none"> The regulating and control components must be installed in an enclosure which corresponds to the requirements of a recognised class of protection in accordance with EN 60 079-0, Section 1.2. When installing in an enclosure with an increased safety class of protection "e" in accordance with EN 60079-7:2007, the clearance and creep age distances set out under Section 4.3, Section 4.4 and Table 1 must be complied with. The component can be used in Group I and II because the requirements of the standard are identical in this case. Work on intrinsically safe circuits, if all live parts that are not designed with intrinsic safety protection type have a cover that corresponds to at least protection type IP 30 (siehe EN/IEC 60079-7:2007). | |
| Intrinsically safe installed components Type 17-6583-.3.. | |
| Test certificate | IBExU05ATEX1074 |
| Ex protection type |  II (2) G [Ex ib Gb] IIC  II (2) D [Ex ib Db] IIIC |
| Standards | EN 60079-0:2012 EN 60079-11:2012 |

| | |
|---|---|
| IECEX | |
| Modex Type 07-7311-..../.... | |
| Test certificate | IECEX PTB 11.0083U |
| Ex protection type | Ex db e [ia Ga] IIC resp. IIB Gb Ex db e [ib] IIC resp. IIB Gb Ex db e [ia Ma resp. ib] I Mb |
| Standards In accordance with Directive 2014/34/EU | IEC 60079-0:2011 Edition: 6 IEC 60079-1:2014-06 Edition: 7 IEC 60079-7:2006-07 Edition: 4 IEC 60079-11:2011 Edition: 6 |
| Ambient temperature | -25 °C bis +60 °C bei T4 |
| Intrinsically safe installed components Type 17-6583-.3.. | |
| Test certificate | IECEX IBE 12.0021 |
| Ex protection type | [Ex ib Gb] IIC [Ex ib Db] IIIC |
| Normen | IEC 60079-0:2011 Edition: 6 IEC 60079-11:2011 Edition: 6 |
| CSA | |
| Test certificate | CSA 2484303 |
| Ex protection type | Class I, Zone 1, II C Ex d e IIC Gb oder Ex d e [ia] IIC Gb resp. IIB Gb Ex d e [ib] IIC Gb resp. IIB Gb |
| INMETRO | |
| Test certificate | TÜV 13.1683 U |
| Customs tariff Union Russia (EAC) | |
| Test certificate | TC RU C-DE.BH02.B.00005 |
| More Test certificate | www.bartec.de |

| | |
|-------------------------|---|
| EU-Comformitaton | |
| RoHS-Directive | 2011/65/EU |
| Standards | EN 61000-6-2:2005 EN 61000-6-4:2007 + A1:2011 EN 55011:2009 + A1:2010 |
| Product labeling | 0044 |

3. Safety Instructions

The "PROFIBUS Coupler/PROFIBUS Repeater" may only be operated in a clean, undamaged condition and may only be deployed within the specified temperature class and the temperature range indicated for it (see type label).

The assembly/dismantling of the regulating and control components must be conducted by qualified personnel authorized and trained to install electrical components in potentially explosive areas.

The use in areas other than those specified or alteration of the product releases BARTEC from liability for defects and further liability. Modifications and changes to the module are not permitted.

The generally applicable statutory regulations and other binding guidelines on occupational health and safety, on accident prevention and on environmental protection must be complied with..

Danger, Warning and Note Symbols

Safety instructions and warnings are specially highlighted in these operating instructions and marked by symbols.

⚠ DANGER

The **DANGER** sign draws attention to a direct threat which if not avoided will lead to death or very serious injuries.

⚠ WARNING

WARNING draws attention to a possible threat which if not avoided can lead to death or very serious injuries.

⚠ CAUTION

CAUTION draws attention to a possible danger which if not avoided can lead to slight or minor injuries

ACHTUNG

ATTENTION draws attention to a potentially damaging situation which if not avoided can cause damage to the equipment or to objects in its vicinity.



Important instructions and information on effective, economical & environmentally compatible handling..

4. Technical Data

Physical characteristics

| Dimensions in mm | (width x height x depth) |
|-----------------------|--------------------------|
| Module Version 30 mm: | 94 mm x 30 mm x 91 mm |
| Module Version 75 mm: | 94 mm x 75 mm x 91 mm |

Module: 30 mm

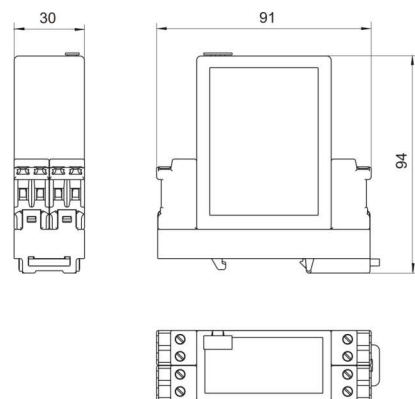

Module: 75 mm

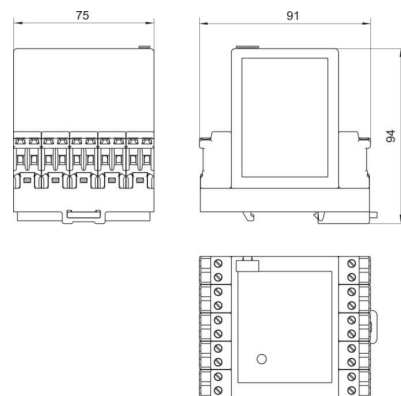

Weight

| | |
|--------------------|-------|
| Modulbreite 30 mm: | 180 g |
| Modulbreite 75 mm: | 250 g |

Mounting position

any

Enclosure material

high-quality thermoplastics

Operation Status

| | | |
|------------------|----------------|------------|
| LED green | U _L | Operation |
| LED green/yellow | BA | Bus active |

Protection class (EN/IEC 60529)

| | |
|----------------------|----------------|
| Terminals | IP20 (minimum) |
| Electronic module | IP66 |
| Terminals with cover | IP30 |

| | |
|---|--|
| Electric connections | terminals 2.5 mm ² , fine-stranded |
| Attachment onto mounting rail (EN/IEC 60715) | TH 35 x 15 (7,5) |
| Terminal marking | inscription label |
| Terminal screws | M 2,5 x 0,45 mm |
| Terminal screw torque | 0,4 Nm |
| Ambient conditions | |
| Ambient temperature | -25 °C bis +60 °C bei T4 |
| Storage/transport temperature | -25 °C bis +70 °C |
| Relative air humidity | 5 % to 95 % non-condensing |
| Vibration (EN 60068-2-6) | 2 g/7 mm, 5-200 Hz in all 3 axes |
| Schock (EN 60068-2-27) | 15 g, 11ms in all 3 axes |
| Electrical Data | |
| Supply voltage | L+, L- DC 20 V to DC 30 V |
| Current consumption | max. 70 mA |
| RS485-Interface | |
| DIN EN 61158-2 | PROFIBUS-DP |
| DIN EN 61784-1 | PROFIBUS-IS |
| Terminating resistor | |
| Ex e | PROFIBUS-DP: Standard |
| Ex i | PROFIBUS-IS: Standard |
| In Coming | Manually switchable |
| Out Coming | always on |
| Data direction switching | Automatically |
| Bus activity | Dynamic |
| Date rate for Ex e | |
| Kbit/s- | 4, 8/9, 6/19, 2/45, 45/93, 75/187, 5/250/375/500/750 |
| Mbit/s- | 1,0/1,5/2,0/3,0/6,0/12,0 |
| Data rate for Ex i | |
| Kbit/s- | 4, 8/9, 6/19, 2/45, 45/93, 75/187, 5/250/375/500/750 |
| Mbit/s- | 1,0/1,5 |
| Switching transmission data rate | manuell |

Please Note

Product Version 2 ('Rev. 2.0' on front label) :



Active change transmission data rate

Product Version 3 ('Rev. 3.0' on front label) :

Change transmission data rate after restart

Product labeling

**example: Profibus Coupler,
Type 07-7311-97WP .4.0**

Front Label

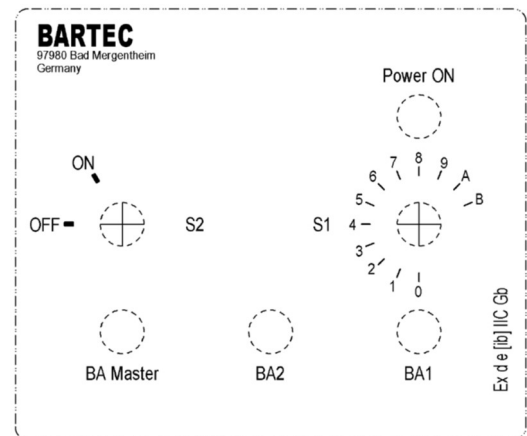

Side Label

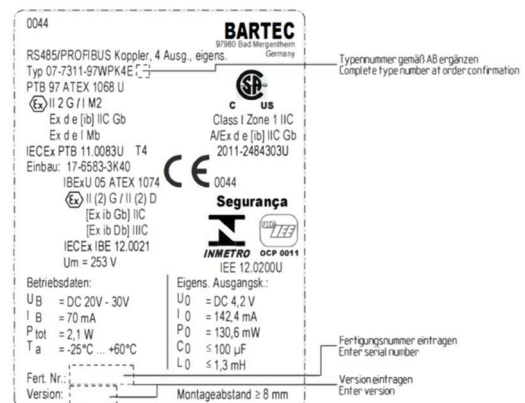

Only version with Intrinsically safe must be mounted of 8mm mounting distance to the next module

Bedienungselemente und Anzeige

On the top side of the devices there are two rotary switches and the operation status display.

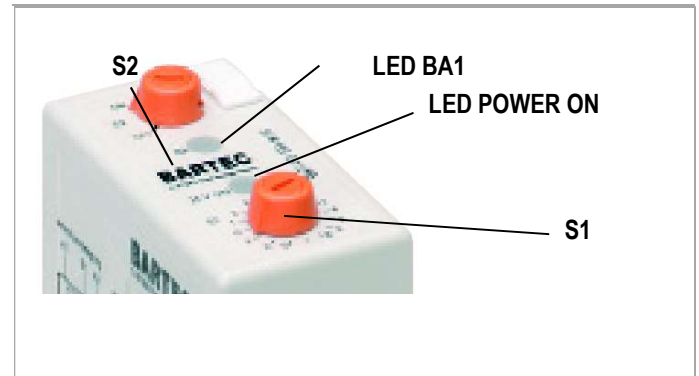
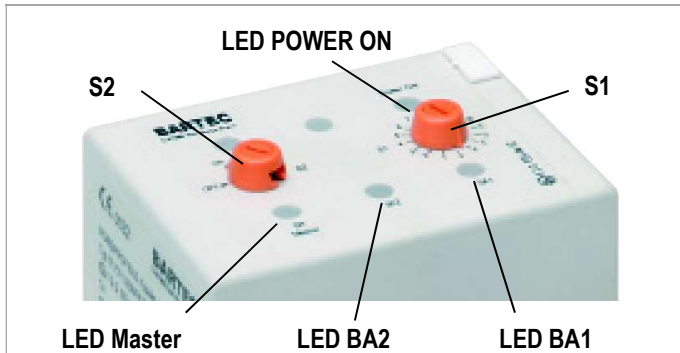

Switch S1 / setting Baudrate

| Switch S1 | 0 | 1 | 2 | 3 | 4 | |
|--------------------|-------|-----|------|-------|-------|-------|
| Baud rate kBit/sec | 4,8 | 9,6 | 19,2 | 45,45 | 93,75 | |
| | 5 | 6 | 7 | 8 | 9 | |
| Baud rate kBit/sec | 187,5 | 250 | 375 | 500 | 750 | |
| Switch S1 | A | B | C | D | E | F |
| Baud rate MBit/sec | 1,0 | 1,5 | 2,0* | 3,0* | 6,0* | 12,0* |

* only for increased safety devices

| BA Master | Bus Activity Master |
|-----------|---|
| | - lights up yellow during activities in master segment (Terminal A;B) |
| BA* | Bus Activity - channel 1 and channel 2 |
| | - lights up green during the activities in segment 1 (terminals A1; B1) |
| | - lights up yellow during activities in segment 2 (terminals A2; B2) |
| | - during activities in both segments lights up in a mixed yellow-green colour |
| BA1** | Bus Activity - channel 1 and channel 2 |
| | - lights up green during activities in segment 1 (terminals A1; B1) |
| | - lights up yellow during activities in segment 2 (terminals A2; B2) |
| | - during activities at both segments lights up in a mixed yellow-green colour |
| BA2** | Bus Activity - channel 1 and channel 2 |
| | - lights up green during activities in segment 3 (terminals A3; B3) |
| | - lights up yellow during activities in segment 4 (terminals A4; B4) |
| | - during activities in both segments lights up yellow-green |

| S1* | Switch for setting baud rate |
|----------|--|
| | <ul style="list-style-type: none"> - This switch is used to manually set the rate of transmission at the bus. - a correlation between the S1 switch designation and the baud rate is shown in Table above. The same table is entered on the plate on the side of the device. - Device version 3: If the device is already in operation when the switch is set, the operating voltage must be switched off and on again for the setting to take effect. - Device version 2: If the device is in operation when the switch is set, the setting will take effect immediately. |
| S2* | Switch for the bus termination |
| | <ul style="list-style-type: none"> - This switch is used to manually set the termination of master bus segment. - Position ON Input (A; B) is terminated - Position OFF Input (A; B) is not terminated |
| Power ON | Operation indicator |
| | <ul style="list-style-type: none"> - Lights up green when the operating voltage 24 V DC is applied. |

* for Type 07-7311-93WP/K1N0, 07-7311-93WP/R1N0, 07-7311-97WP/K1E0, 07-7311-93WP/K2N0, 07-7311-93WP/R2N0

** for Type 07-7311-97WP/K4N0, 07-7311-97WP/R4N0, 07-7311-97WP/K4N0

5. Transport and storage

ATTENTION

Damage due to incorrect storage!

- ▶ Observe storage and transport temperatures.
- ▶ Condensation can arise on components in a cold environment.
- ▶ Use the original packaging for transport/storage.

6. Assembly

WARNING

Danger in the case of incorrect procedure!

- ▶ Installation outside of the hazardous area in the enclosure, at least IP20 or closed switchgear.
- ▶ The assembly, dismantling, installation and commissioning may only be executed by a skilled electrician who has been authorised and trained to carry out the assembly of electrical components in a potentially explosive area.
- ▶ The pertinent regulations for setting up and operation must be observed when setting up or operating explosion protected electrical installations. These include Directive 1999/92/EC, Directive 94/9/EC, BetrSichV (the German Ordinance on Industrial Health and Safety), EN 60079-14, the DIN VDE 0100 series or other nationally applicable standards or regulations.

DANGER

Incorrect use, faulty installation and operation jeopardise the explosion protection and can lead to serious injuries and damage to property.

The following special conditions must be heeded!

- ▶ The following special conditions must be heeded! Do not install and commission components that have been stored in a cold environment. Take condensation into consideration!
- ▶ The enclosure has been sealed in the factory. The enclosure must not be opened!
- ▶ Before installation, check whether the components are in perfect condition.
- ▶ No conversions or changes to the module may be made.
- ▶ All screws and terminals must be tightened using a torque wrench, taking account of the recommended connection torque for screws and terminals of 0.4 Nm to 0.7 Nm. Suitable measures must be taken to ensure this.
- ▶ Ensure the unit is dead (be aware of consumers with stored energy)
- ▶ Cover any live neighbouring components.
- ▶ The low-resistance PA connection part must be connected to the equipotential bonding conductor of the explosion protection device. Since the intrinsically safe circuits are galvanically connected to earth potential, they must belong to the same level as the intrinsically safe circuits.
- ▶ Decommission the device in the event of a fault!

Functional schematic

The PROFIBUS coupler and the PROFIBUS repeater functionally have the same structure.

The difference between the PROFIBUS coupler and the PROFIBUS repeater lies in the software that is programmed in the FPGA logic module. This module is programmed at the factory before the device is delivered. The devices also differ in the following:

The PROFIBUS coupler processes electrical signals. The PROFIBUS repeater also prepares the timing of the signal.

A PROFIBUS driver block is connected to each PROFIBUS connection (AB; A1B1; A2B2 ...). The PROFIBUS driver block converts the PROFIBUS signals into logical internal signals and vice versa.

The input and the outputs are galvanically separated by three optocouplers.

Electrical, logical and temporal signal processing are carried out in the FPGA module. The time processing can be set precisely using switch S1 (baud rate). The FPGA block also generates signals for the control of the status display (BA, BA1, BA2). The input is terminated with the aid of switch S2.

The entire circuit is supplied with an internal power supply unit. The power pack is designed in accordance with the applicable Ex standard. The power supply unit electrically isolates the power supply / input / output.

Application

The application of the device is based on the RS485 standard.

The electrical reference data are determined as follows:

1. Max. of 32 stations per potential segment
2. Linear structures
3. Bus line termination at the beginning and end of the bus line
4. Total of all branch line lengths max. 5 m without termination resistance
5. Maximum length of a bus line 1200 m

The maximum segment length as a function of the rate of transmission is shown in Table III

Electrical isolation / Bus segmentation

- Enables multiple extensions of the maximum bus line.
- Increases the availability of the individual segments, even in the event of a bus line short-circuit because the other segments are electrically isolated
- Allows the number of stations to be increased to 32xN (N corresponds to the quantity of segments)
- Allows a higher rate of transmission due to the division into shorter segments.
- Tree, star and other hybrid/network structures.
- Due to the use of PROFIBUS couplers / PROFIBUS repeaters, it is possible for the first time to use complex structures independently of the remaining segments. At the same time it is possible to exploit the maximum length of active branch lines in each segment.

Project planning

In the project planning of complex structures it is essential to observe the following:

PROFIBUS couplers/PROFIBUS repeaters do not have their own addresses and as a basic rule they are therefore transparent for the protocol. Signals are only processed electrically. The data are passed on without alteration.

Data are only transmitted in the master-slave direction or slave master, there is no provision for a transmission of data between different slave connections.

A bus structure must be planned in such a way that the master side of the device (terminals A; B) should always be connected to the higher ranking side of the bus structures (PLC).

A short-circuit or bus interruption on the lower level does not have any influence on higher ranking or other separate segments.

Bus termination

Generally the BUS has to be terminated at the beginning and at the end of the bus segment. The slave-outputs, which as a basic rule form new segments, have internally fitted bus terminations. If a PROFIBUS coupler/ PROFIBUS repeater is used at the end of the bus (terminals A; B), the bus may be terminated with the aid of the S2 switch and the internally fitted bus termination (S2 in position ON). If a PROFIBUS coupler/PROFIBUS repeater is used in the middle of the bus line (terminals A; B), the bus may not be terminated at this point (S2 in position OFF). The bus must be terminated at the end of the line with e.g. termination resistance.

7. Installation

Attention

Damage due to improper handling!

- ▶ Only qualified specialists may carry out the commissioning and installation

Cables, Connection, Earthing

Data cables conform to the PROFIBUS standards. Branch lines are permissible but the total length of branch lines in each segment should not exceed a length of 5 m. The length of each segment depends on the baud rate and is entered in Table III.

For EMC reasons it is necessary to earth the cable shield. As a basic rule, shielding must adhere to section 12.2.2.3 of EN 60079-14 and the PROFIBUS manual

The PROFIBUS coupler/PROFIBUS repeater is installed in an enclosure of at least a protection class of at least IP 54.

The PROFIBUS-coupler/PROFIBUS-repeater must installing in an enclosure with an increased safety class of protection "e" in accordance with EN 60079-7:2007

modules are supplied with DC 20 V-30 V.

The devices are connected by means of terminal screws.

The intrinsically safe devices are connected exclusively through the blue connection terminals. Interconnecting intrinsically safe and non-intrinsically safe devices is functionally possible but the intrinsic safety gets lost.

The rate of transmission for Ex e devices are 4.8 kBit/s to 12 MBit/s and for Ex i devices 4.8 kBit/s to 12 MBit/s is set manually with the aid of the S1 switch.

The bus termination connection depends on the position of the device.

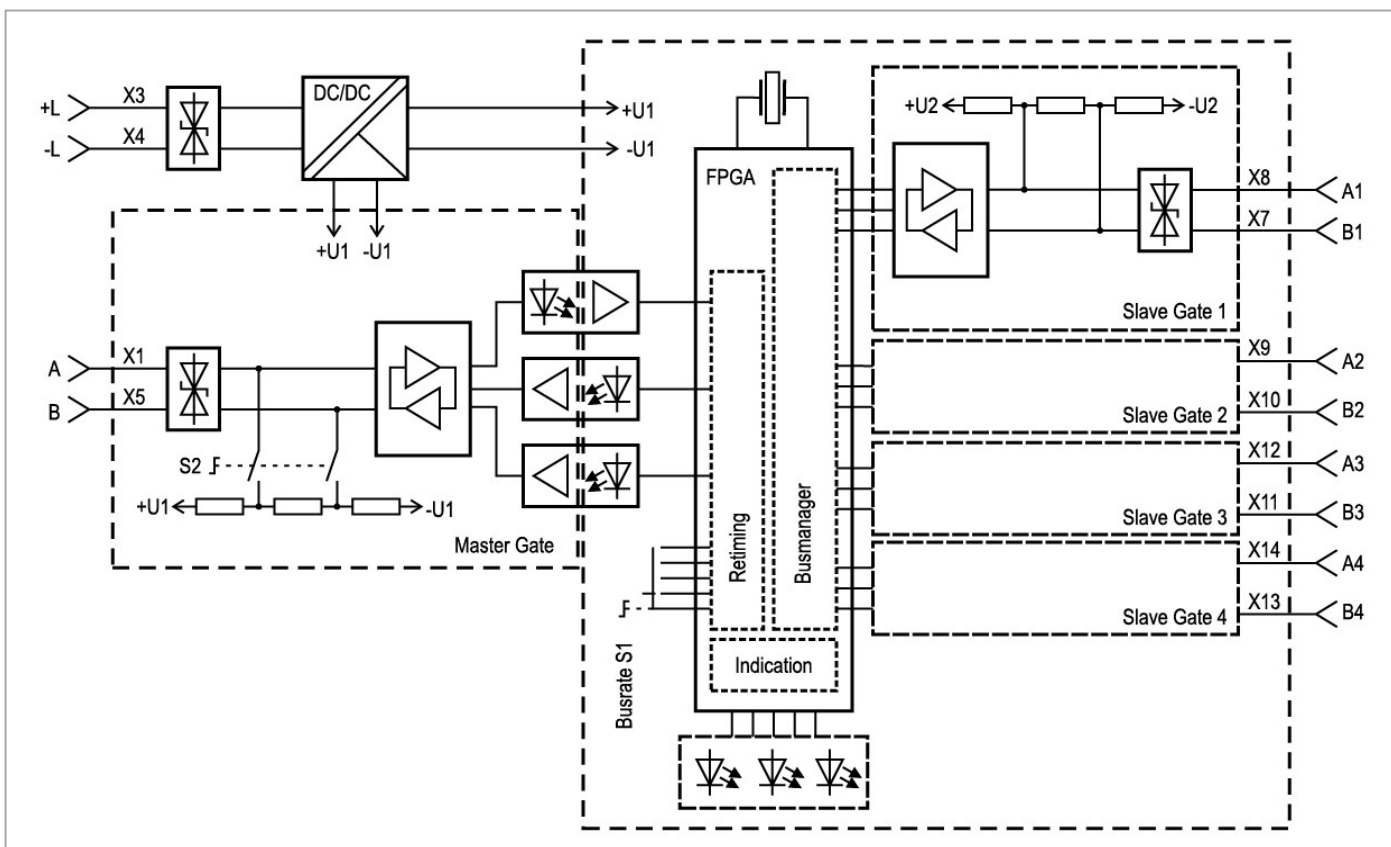

Terminal

Connection inputs

| | |
|-----------------------|------------------|
| A | PROFIBUS Input A |
| B | PROFIBUS Input B |
| Supply voltage | |
| L+ | DC +24 V |
| L- | DC 0 V |

Connection outputs

| | |
|----|------------------------------|
| A1 | PROFIBUS Output A, Channel 1 |
| B1 | PROFIBUS Output B, Channel 1 |
| A2 | PROFIBUS Output A, Channel 2 |
| B2 | PROFIBUS Output B, Channel 2 |
| A3 | PROFIBUS Output A, Channel 3 |
| B3 | PROFIBUS Output B, Channel 3 |
| A4 | PROFIBUS Output A, Channel 4 |
| B4 | PROFIBUS Output B, Channel 4 |

Terminal assignment

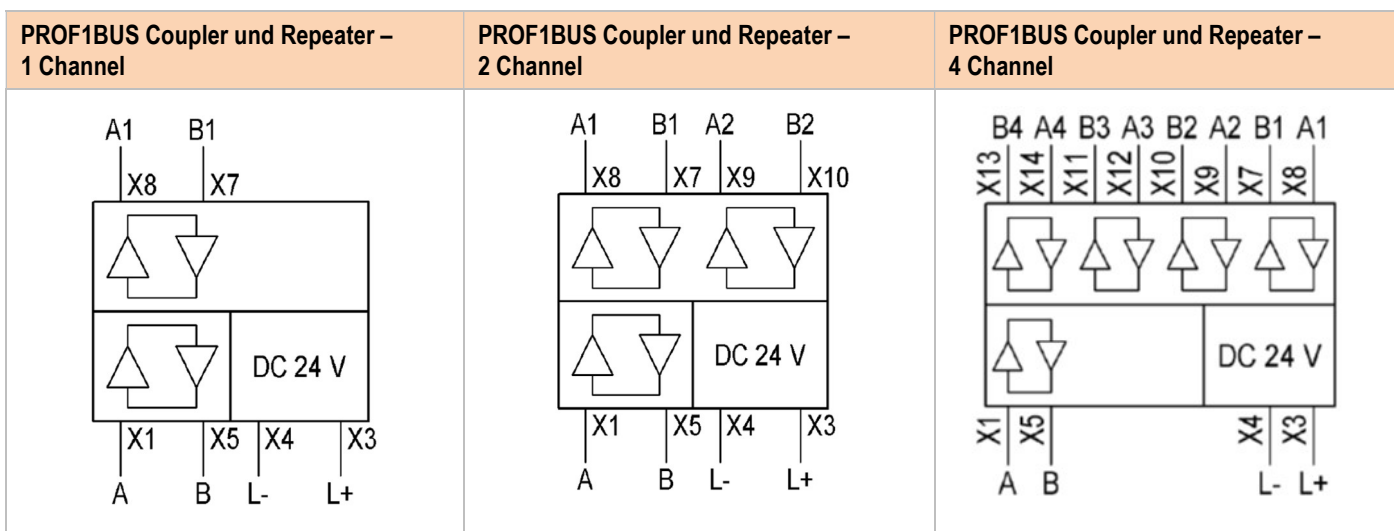

Table 1

| Baudrate Bit/Sec | 4,8 K | 9,6 K | 19,2 K | 93,75 K | 187,5 K | 0,5 M | 1,5 M | 3M | 6 M | 12 M |
|-----------------------------------|-------|-------|--------|---------|---------|-------|-------|-----|-----|------|
| Segment length [km] | 1,2 | 1,2 | 1,2 | 1,2 | 1,0 | 0,4 | 0,2 | 0,1 | 0,1 | 0,1 |
| Cascadability, Coupler max. | 8 | 8 | 8 | 8 | 8 | 8 | 6 | 6 | 4 | 4 |
| Cascadability, Repeater max. | 12 | 12 | 12 | 12 | 12 | 12 | 10 | 8 | 8 | 8 |
| Bus extension, coupler max. [km] | 9,6 | 9,6 | 9,6 | 9,6 | 8,0 | 3,2 | 1,2 | 0,6 | 0,4 | 0,4 |
| Bus extension, repeater max. [km] | 14,4 | 14,4 | 14,4 | 14,4 | 12,0 | 4,8 | 2,0 | 0,8 | 0,8 | 0,8 |

8. Commissioning

Check before commissioning:

- (1) Has the module been installed correctly?
- (2) Is the enclosure undamaged?
- (3) Has the connection been carried out correctly?
- (4) Have you checked that the wiring is correct?
- (5) Does the module function correctly?

9. Operation

Once the final check has been conducted, the device can be put into operation.

⚠ DANGER

There is danger to life if the device is not used correctly!

- ▶ Comply with the special explosion protection conditions.
- ▶ Only operate within the approved temperature range.

10. Possible Faults and Corrective measures

Troubleshooting when establishing a connection

| Faults | Possible Cause | Corrective measures |
|--|--|---|
| <ul style="list-style-type: none"> ■ "Power ON" display does not light up. ■ No data transmission. | <ul style="list-style-type: none"> ■ Power supply is not connected, or not switched on. | <ul style="list-style-type: none"> ■ Check voltage or wiring. |
| <ul style="list-style-type: none"> ■ "Power ON" display lights up. ■ No data transmission. | <ul style="list-style-type: none"> ■ Data cable is not connected or is connected incorrectly. | <ul style="list-style-type: none"> ■ Check data cable connections. ■ Check if the cable polarity is correct. |
| <ul style="list-style-type: none"> ■ "Power ON" display lights up. ■ No data transmission. | <ul style="list-style-type: none"> ■ End devices are not connected, or incorrectly connected or are not switched on. | <ul style="list-style-type: none"> ■ Check if the end device is connected correctly or if it functions correctly. |
| <ul style="list-style-type: none"> ■ The "Power ON" display lights up. ■ The end devices function. ■ No data transmission or faulty data transmission | <ul style="list-style-type: none"> ■ The control's rate of transmission does not agree with that of the PROFIBUS coupler / PROFIBUS repeater. | <ul style="list-style-type: none"> ■ Use the S2 switch to adjust the control's rate of transmission to that of the PROFIBUS coupler/ PROFIBUS repeater. |
| <ul style="list-style-type: none"> ■ "Power ON" display lights up. ■ End devices function. ■ No data transmission, or data transmission is faulty. | <ul style="list-style-type: none"> ■ Bus termination is incorrectly dimensioned. | <ul style="list-style-type: none"> ■ Check the quantity and the position of termination resistances. ■ Use the S1 switch to adjust the required quantity of connection resistances. |

11. Maintenance, Inspection, Repair

Only authorised and qualified personnel may do any work on the control and regulating component.

Maintenance

If operated correctly in accordance with the installation instructions and ambient conditions, it does not require maintenance.

Under EN/IEC 60079-17 and EN/IEC 60079-19 the owner/managing operator of electric installations in hazardous areas is obliged to have these installations checked by a qualified electrician to ensure that they are in a proper condition.

Repair

The component cannot be repaired. Please contact BARTEC GmbH if you have any questions.

12. Disposal

The regulating and control components contains metallic and plastic parts and electronic parts..

Our devices involve electrical equipment which is only intended for commercial use (so-called B2B equipment in accordance with the WEEE Directive).



The regulating and control components must be disposed of in accordance with national regulations.

Our customers may return any products procured from us to our company for disposal. The sender must bear the costs for shipping/packing.

13. Amendments to the Document

BARTEC GmbH reserves the right to change the contents of this document without notification. We assume no guarantee for the correctness of the information. In cases of doubt the German safety instructions apply because it is not possible to rule out errors during printing and translation. The "General Terms and Conditions of Business" of the BARTEC Group moreover apply in the event of legal disputes.

The current version of data sheets, operating instructions, certificates and EC declarations of conformity can be downloaded from www.bartec.de or directly requested from BARTEC GmbH.

14. Order Numbers

PROFIBUS-DP Coupler - increased safety

| Description | Options | Module width | Order no. |
|---------------------|-----------------|--------------|--------------------------|
| PROFIBUS-DP Coupler | Ex e, 1 output | 30 mm | 07-7311-93WP/K1NO |
| PROFIBUS-DP Coupler | Ex e, 2 outputs | 30 mm | 07-7311-93WP/K2NO |
| PROFIBUS-DP Coupler | Ex e, 4 outputs | 75 mm | 07-7311-97WP/K4NO |

PROFIBUS-DP Repeater - increased safety

| Description | Options | Module width | Order no. |
|----------------------|-----------------|--------------|--------------------------|
| PROFIBUS-DP Repeater | Ex e, 1 output | 30 mm | 07-7311-93WP/R1NO |
| PROFIBUS-DP Repeater | Ex e, 2 outputs | 30 mm | 07-7311-93WP/R2NO |
| PROFIBUS-DP Repeater | Ex e, 4 outputs | 75 mm | 07-7311-97WP/R4NO |

PROFIBUS Gateway DP/IS

| Description | Options | Module width | Order no. |
|------------------------|-----------------|--------------|--------------------------|
| PROFIBUS Gateway DP/IS | Ex i, 1 output | 75 mm | 07-7311-97WP/K1EO |
| PROFIBUS Gateway DP/IS | Ex i, 2 outputs | 75 mm | 07-7311-97WP/K2EO |
| PROFIBUS Gateway DP/IS | Ex i, 4 outputs | 75 mm | 07-7311-97WP/K4EO |

15. Service address

BARTEC GmbH
Max-Eyth-Straße 16
97980 Bad Mergentheim
Germany

Telefon +49 7931 597-0
Fax +49 7931 597-119

E-Mail: info@bartec.de
Internet: www.bartec.de

Example of use (see illustration)

The use of the PROFIBUS coupler/PROFIBUS repeater allows various combinations of star, tree and cascading linear structures to be configured. The illustration shows a possible application of the PROFIBUS coupler/ PROFIBUS repeater.

Explanation:

- a) The use of the coupler **A** allows the formation of four independent segments. This makes it possible to connect devices in different areas of the system independently.
- b) Line **B** is looped through the device in the distribution box enclosure **2** and pulled on further to the distribution box enclosure **C**. This connection gives rise to a typical PROFIBUS linear structure.

- c) An EEx i coupler is used in the distribution box **C**. It forms a further four intrinsically safe segments. All the measuring instruments **4** are intrinsically safe devices and are used in zone 0. In addition, a 2-channel coupler is used in the distribution box enclosure. It is connected to two EEx e devices.
- d) A coupler is used in the distribution box **D**; this forms a further four segments.
- e) A repeater is used in the distribution box **E**. The solenoid valves **7** and further measuring instruments are used to control and observe a gas turbine compressor with a capacity of 10 kW. Using a repeater improves the signals in the harsh EMC-environment.

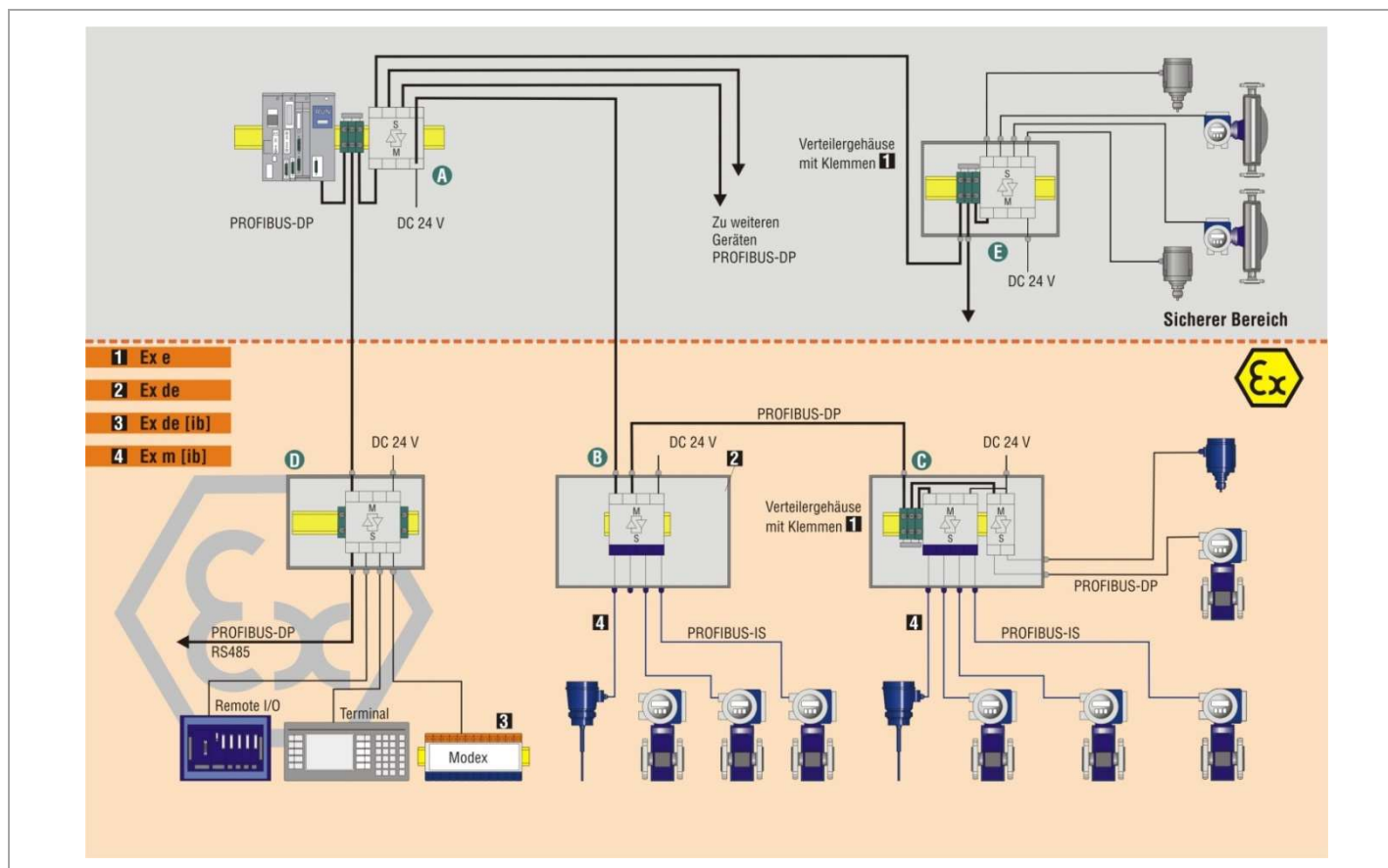



Declaration of EU-Conformity

Konformitätsbescheinigung
 Attestation of Conformity
 Attestation de conformité

BARTEC

BARTEC GmbH
 Max-Eyth-Straße 16
 97980 Bad Mergentheim
 Germany

N^o 01-7311-7C0002_B

| Wir | We | Nous |
|---|---|---|
| BARTEC GmbH, | | |
| erklären in alleiniger Verantwortung, dass das Produkt | declare under our sole responsibility that the product | attestons sous notre seule responsabilité que le produit |
| Steuer- und Regel-Komponente RS485 Profibuskoppler / Profibusrepeater | Control Component RS485 Profibus coupler / Profibus repeater | Composants de commande et de régulation RS 485 Coupleur Profibus/ Repeteur Profibus |
| 07-7311-9*WP/K**N* 07-7311-9*WP/R**N* 07-7311-97WP/K**E* | | |
| auf das sich diese Erklärung bezieht den Anforderungen der folgenden Richtlinien (RL) entspricht | to which this declaration relates is in accordance with the provision of the following directives (D) | se référant à cette attestation correspond aux dispositions des directives (D) suivantes |
| ATEX-Richtlinie 2014/34/EU EMV-Richtlinie 2014/30/EU RoHS-Richtlinie 2011/65/EU | ATEX-Directive 2014/34/EU EMC-Directive 2014/30/EU RoHS-Directive 2011/65/EU | Directive ATEX 2014/34/UE Directive CEM 2014/30/UE Directive RoHS 2011/65/UE |
| und mit folgenden Normen oder normativen Dokumenten übereinstimmt | and is in conformity with the following standards or other normative documents | et est conforme aux normes ou documents normatifs ci-dessous |
| EN 60079-0:2012+A11:2013 EN 60079-1:2014 EN 60079-7:2007 EN 60079-11 :2012 | EN 61000-6-2:2005 EN 61000-6-4:2007+ A1:2011 EN60529:1991+A1:2000 +A2:2013 | |
| Kennzeichnung | Marking | Marquage |
| | 07-7311-9*WP/K**N* 07-7311-9*WP/R**N*  II 2G Ex db e IIC I M2 Ex db e I Mb 07-7311-97WP/R**E*  II 2G Ex db e [ib] IIC Gb I M2 Ex db e [ib] I Mb | |

00-0383-0363

Seite / page / page 1 von / of / de 2



01-7331-7D0001 / Version: 4. April 2021 / 243586

Konformitätsbescheinigung
 Attestation of Conformity
 Attestation de conformité

BARTEC

BARTEC GmbH
 Max-Eyth-Straße 16
 97980 Bad Mergentheim
 Germany

N^o 01-7311-7C0002_B

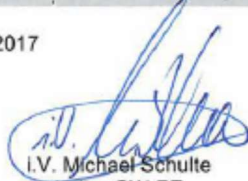
| Einbau | Fitting | Contenu |
|--|--|--|
| Type : 17-6583-3***/*  II 2G [Ex ib Gb] IIC II 2D [Ex ib Db] IIIC | | |
| Verfahren der EU-Baumusterprüfung / Benannte Stelle | Procédure of EU-Type Examination / Notified Body | Procédure d'examen UE de type / Organisme Notifié |
| Gehäuse: PTB 97 ATEX 1068 U 0102 PTB, Bundesallee 100, 38116 Braunschweig, Deutschland Gehäuse 0044 Einbau: IBExU 05 ATEX 1074 0637 IBExU, Fuchsmühlenweg 7, 09599 Freiberg, Deutschland  0044 | | |
| (1) Die Ex-Komponente ist Teil eines elektrischen Betriebsmittels oder eines Moduls, das mit dem Symbol „U“ gekennzeichnet ist, das nicht für sich allein verwendet werden darf und über dessen Einbau in elektrische Betriebsmittel oder Systeme zur Verwendung in explosionsgefährdeten Bereichen gesondert entschieden werden muss. | (1) The Ex-component is a part of an electrical apparatus or a module, marked with the symbol „U“, which is not intended to be used alone and requires additional consideration when incorporated into electrical apparatus or systems for use in explosive atmospheres. | (1) Le composant Ex est partie de matériel électrique ou de module, marquée du symbole „U“, ne devant pas être utilisée seule et nécessitant une certification complémentaire lorsqu'elle est incorporée à un matériel électrique ou à un système pour atmosphères explosives. |
| Merkmale dieser Komponenten sowie die Bedingungen für ihren Einbau in Geräte und Schutzsysteme siehe Betriebsanleitung der Komponente. | Characteristics and how the component must be incorporated into equipment or protective systems see operation manual of the component. | Les caractéristiques du composant ainsi que les conditions d'incorporation dans des appareils ou des systèmes de protection regarde voir l'instruction d'emploi du composant. |
| Bad Mergentheim, den 20.02.2017  i.V. Nader Halmuschi BU Leiter | | |
|  i.V. Michael Schulte Leiter GW PZ | | |

► All Certificates see www.bartec.de