

Monitoring device RLA^{net}

Operation and Installation Manual

Monitoring device for BARTEC water detection systems
Type 17-85G5-2123****



Translation of the origin Operation and Installation Manual

Language: EN

Table of Contents

1. Product description	5	9.6. Viewing the event log	19
2. Safety regulations	5	10. Operating states	21
2.1. Intended use	5	10.1. Operating state Normal	21
2.2. Foreseeable misuse	6	10.2. Operating state Leak	21
2.3. Personnel qualifications	6	10.3. Operating state Service/Break	21
2.4. Symbols and signs	6	11. Operation	22
3. Technical data	7	12. Maintenance	23
3.1. Wiring diagram	8	13. Decommissioning, dismantling	23
4. Device description	10	14. System accessories	24
4.1. Module description	10	15. EU Declaration of Conformity	25
4.2. Software description	11	16. Annexes	26
5. Functional description	12	16.1. Test reports (SCR, PS/PSO)	27
6. System planning	12	16.2. Start-up report	29
6.1. Modbus RTU communication	12	16.3. Example system planning	30
7. Assembly	13	16.4. PC settings	31
7.1. Mechanical assembly	13	16.5. USB computer interface	32
7.2. Electrical assembly	13	16.6. Information on project planning, wiring diagrams	33
7.3. Laying of the sensor cable	13		
7.4. Connecting the point sensors	13		
8. Commissioning	14		
9. The service programme	14		
9.1. Starting the service programme	15		
9.2. Setting the interface, creating a connection to RLA ^{net}	16		
9.3. Setting the sensor parameters	17		
9.4. Setting the date and time	18		
9.5. Controlling leakage monitoring	18		

1. Product description

The RLA^{net} monitoring device is a component of the BARTEC water detection system and is used to detect electrically conductive and non-electrically conductive liquids.

Together with the SCR sensor line and the PS point sensor, the RLA^{net} monitoring device can detect electrically conductive liquids, together with the PSO/PSO+ point sensor, electrically non-conductive liquids can be detected.

The system quickly and reliably detects smaller leaks and generates an optical and acoustic warning signal. The floating contact is switched at the same time to forward the signal to the PLC or a building management system.

With the integrated software of the RLA^{net} monitoring device, it is possible to establish an exact localisation of the leak that has occurred. The leakage is determined with an accuracy of one meter and shown on the four-digit display.

The speed at which a leak is detected depends on the volume and conductivity of the leaked liquid. The SCR sensor line achieves the shortest response time when it is completely surrounded by water (approx. 5 mm water level) or when it is surrounded by a sensor line length of at least 20 cm. Due to its geometry, a minimum amount of leaking liquid is required for detection by the point sensor PS or PSO/PSO+. See the point sensor data sheet for more information.

Product variants

Type	Variant
17-85G5-21230000	for the assembly of top-hat rails
17-85G5-21230100	within the IP housing: 1 universal power pack, 1 monitoring device RLA ^{net} , 1 power relay
17-85G5-21230200	within the IP housing: 1 universal power pack, 2 monitoring devices RLA ^{net} , 2 power relays
17-85G5-21230400	within the IP housing: 2 universal power packs, 4 monitoring devices RLA ^{net} , 4 power relays

More upon request.

2. Safety regulations

The RLA^{net} monitoring device is state-of-the-art and reliable. In order to ensure safe operation, careful system planning, proper transport, professional assembly, commissioning and maintenance of all components used is required.

RLA^{net} may only be operated and used in accordance with its intended use in compliance with these assembly and operating instructions, the applicable national standards, regulations and approvals (e.g. directives 2014/30/EU, DIN VDE series 0100).

Improper use or handling of the product can result in serious personal injury or death. This can also damage the product, the system and the environment.

BARTEC GmbH assumes no liability for damages resulting from the installation and use of the software, and in particular not for personal injuries and property damages as well as financial losses that are directly or indirectly associated with the use of the software.

Please read carefully through these assembly and operating instructions in full before you carry out any work on the RLA^{net} or the system. The instructions and warnings included in these assembly and operating instructions must be read, understood and observed.

Keep the manual near the RLA^{net} monitoring device for future reference and pass it on to new owners where relevant.

Product specifications are subject to change without prior notice. Claims for damages resulting from changes, errors or misprints are excluded.

2.1. Intended use

The RLA^{net} monitoring device is used to detect and localise electrically conductive and non-electrically conductive liquids. It is intended for the use outside of potentially explosive atmospheres.

The RLA^{net} monitoring device is intended for operation with a suitable control line or the SCR sensor line and the PS point sensor or the PSO/PSO+ point sensor.

Before start-up, the parameters set on the monitoring device must be compared with the actually required parameters of the system and corrected if necessary. Set parameters must match the installed components of the system.

All system components may only be operated as intended and within their specifications (technical data). The applicable national installation regulations must be observed.

The information in these assembly and operating instructions for the respective life phases must be observed and complied with.

2.2. Foreseeable misuse

The use of the RLA^{net} monitoring device is **not permitted**:

- outside of its intended use
- with non-approved or unintended components
- in potentially explosive areas
- outside of its specifications (technical data)
- the technical modification or opening of the component
- without observing the information in the assembly and operating instructions and applicable national installation regulations

2.3. Personnel qualifications

Only trained personnel may use the RLA^{net} monitoring device. The personnel must have basic electrical knowledge.

The wiring for electrical installations and, if necessary, for maintenance or changes to the installed system may only be carried out by a qualified electrician.

Decommissioning and dismantling may only be carried out by trained persons. Disposal is only permitted through an approved specialist company.

2.4. Symbols and signs

The warnings shall be intended to protect against dangerous situations, personal injury and damage to property.

In the operating instructions, the severity of the possible dangers is indicated by the following signal words.

	<p>DANGER!</p> <p>DANGER indicates an imminent danger. If not avoided, death or serious injury will result.</p>
--	--

	<p>WARNING!</p> <p>WARNING indicates a potentially imminent danger. If not avoided, it can result in death or serious injury.</p>
--	--

	<p>CAUTION!</p> <p>CAUTION indicates a potentially imminent danger. If not avoided, minor injuries may result.</p>
---	---

	<p>ATTENTION!</p> <p>ATTENTION indicates a potentially harmful situation. If not avoided, the plant or something in its vicinity may be damaged.</p>
---	---

	<p>PLEASE NOTE!</p> <p>PLEASE NOTE indicates notes and information on an effective, economical and environmentally friendly handling.</p>
---	--

3. Technical data

General

Type of control	Monitoring device for the detection and localisation of electrically conductive and non-electrically conductive liquids
Display	1 line, four digits with 7 segments respectively, height 10 mm, colour red; an additional 3 LED's: Power red LED (relay dropped out) Service green LED (relay energized) Leak green LED (relay energized)
Alarm signal	Optical with LED's, acoustically with piezoelectric buzzer
Measurement and display accuracy	1.0 m
Ambient temperature range	-20 °C to +50 °C, with 5% to 95% humidity, not condensing
Storage temperature	-40 °C to +60 °C
Housing	thermoplastic material, fastening onto DIN top-hat rail TS35
Connection	Screw terminal, 0.25 mm ² - 1.5 mm ²
Measurements	86 mm x 70 mm x 53 mm (WxHxD)
Type of protection	IP20

Electrical data

Power supply	12 V to 24 V DC, ±10%
Power consumption	3 W
Alarm relay	U _{max} AC 125 V; I _{max} 0,5 A; AC-12 U _{max} DC 24 V; I _{max} 1,0 A; DC-13
Measurement method	Electrical conducted with sensor cable SCR and sensor PS >30 µS, Sensor PSO/PSO+ can be integrated in the measuring circuit

Connection

Terminals	Alarm relay power connection, leak sensor, RS485 (4 terminals)
Leak sensor limits	Max. length of SCR sensor line: 500 m Max. number of point sensors PS, PSO/PSO+: 50 pcs. 50 PS or PSO+ (60 Ohm) or 500 m SCR sensor cable (6 Ohm/m) can be connected to each RLA ^{net} . The sensors can also be mixed. It is important to ensure that the resistance does not exceed the maximum limit of 3000 ohms.

Conformity in accordance with

- EN 62321:2009
- EN 61326-1:2013
- EN 61000-3-2:2014

and compliance with directives 2014/30/EU (EMC directive) and 2011/65/EU (RoHS directive) is confirmed by the manufacturer.

3.1. Wiring diagram

Connection as a stand-alone system

Connection of sensors, cables and plugs

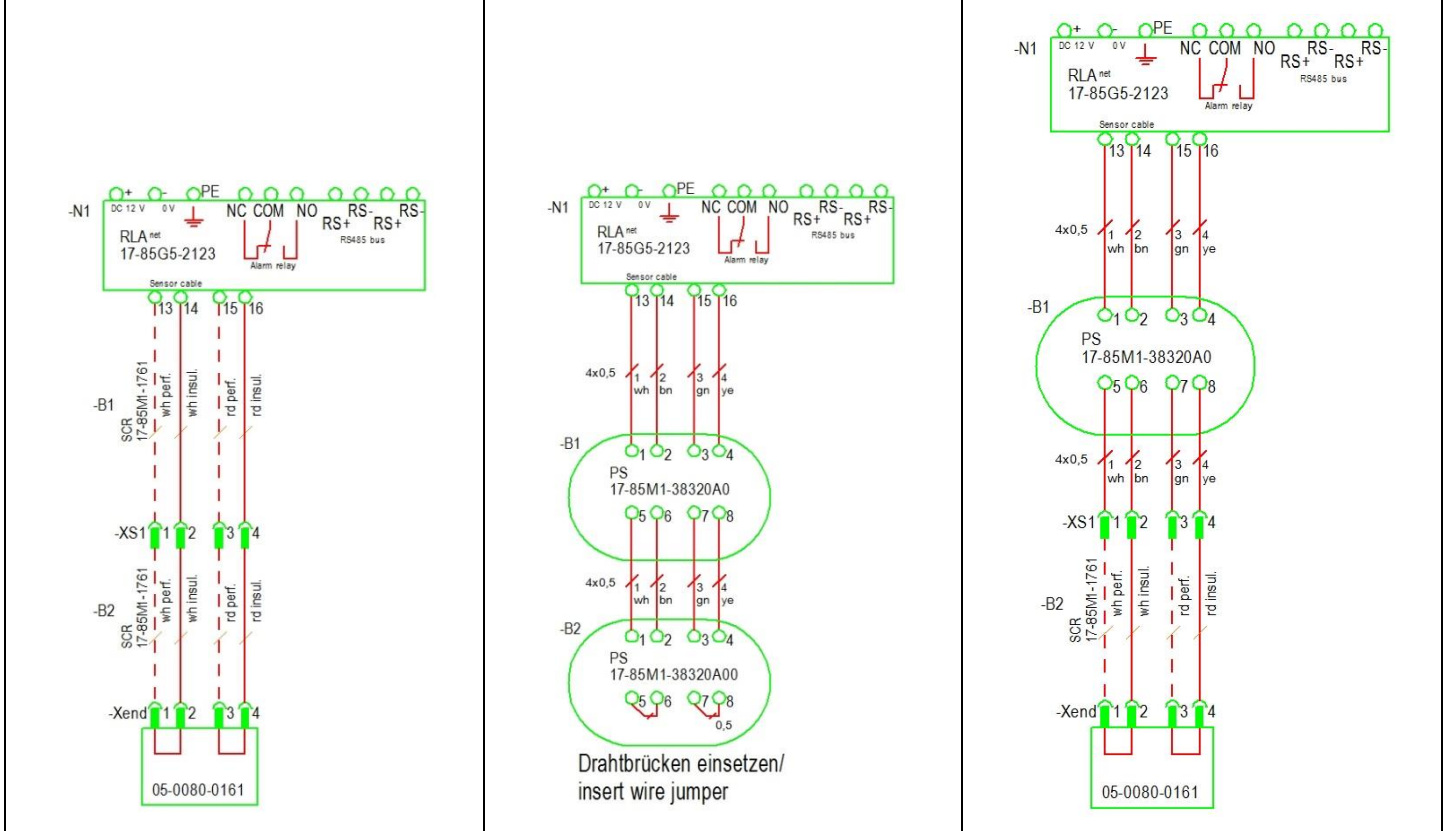

Key

N1	Monitoring device RLA ^{net}
B1	SCR sensor line, PS sensor
B2	SCR sensor line, PS sensor
XS1	Plug/plug-in coupling M12 (BARTEC item 05-0091-0054, item 05-0091-0055)
Xend	Terminating plug (BARTEC Art. 05-0080-0161)

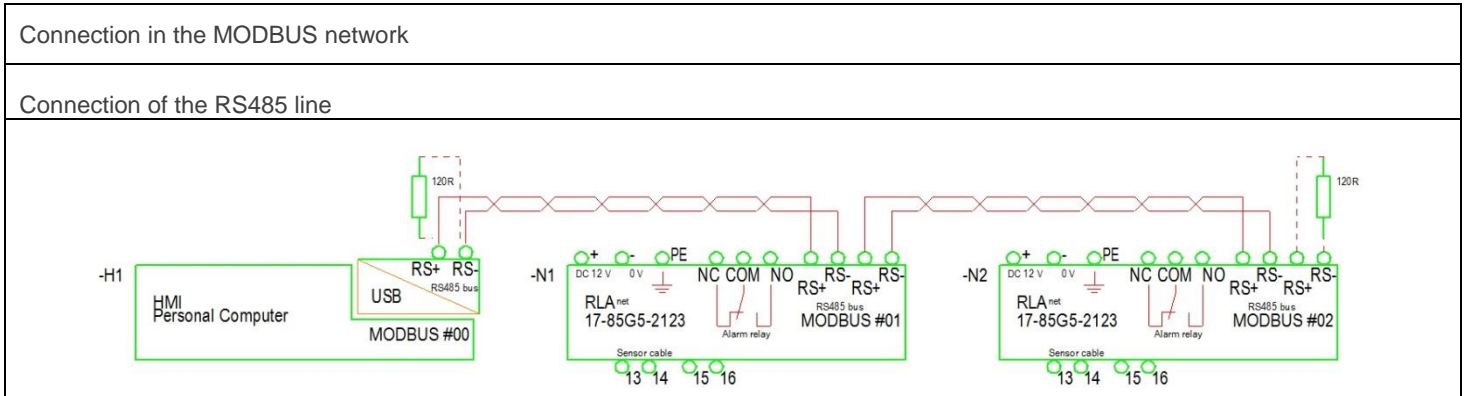

Key

N1 Monitoring device RLA^{net}

H1 HMI, such as PC

RS485-Leitung Twisted pair cable, 2x 0.5 mm²

120R Termination resistance (optional)

In the event of transmission errors, the optional use of a bus termination with $R=120\text{ Ohm}$ or a data line $Z_0=120\text{ Ohm}$ is possible.

Connection and switching situations

				LED		
Voltage	Relay contact	Display	Output status	Power	Leak	Service
OUT	NO-COM	no leak	open	OUT	OUT	OUT
ON	NO-COM	no leak	open	ON	OUT	OUT
		leak	closed	ON	ON	OUT
		power failure	open	OUT	OUT	OUT
		broken sensor line	open	ON	OUT	ON
ON	NC-COM	no leak	closed	ON	OUT	OUT
		leak	open	ON	ON	OUT
		power failure	closed	OUT	OUT	OUT
		broken sensor line	closed	ON	OUT	ON

4. Device description

4.1. Module description

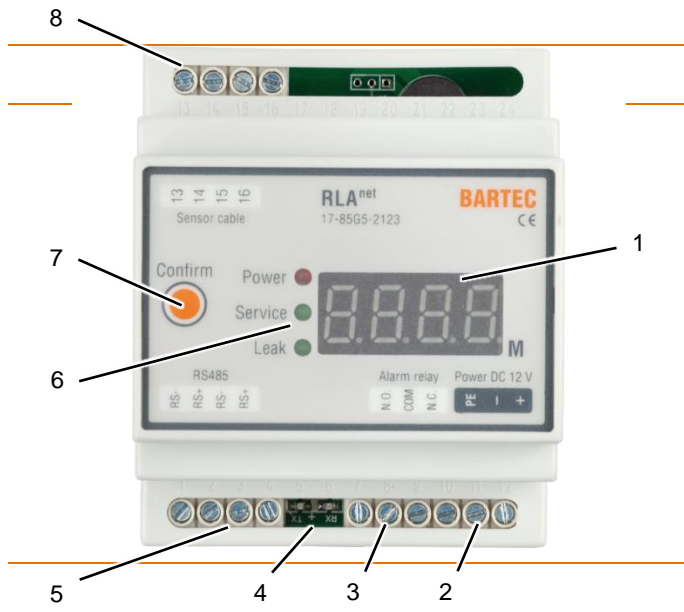

Key

Item	Description	Function
1	Display, 4 digits	Description of the location of the leak (no leaks, distance to the leak in running meters)
2	Power supply connection	
3	Connection alarm relay	
4	LED, Modbus RTU communication (RX = incoming, TX = outgoing)	Display of the interface communication
5	RS485 communication interface connection	
6	LED, devices and system status	Display of the device and system status (power, service, leak)
7	"Confirm" button	Acknowledging error messages
8	Connection sensor cable, 4-wire	

Description of the display

----	no leak
12.3	leakage at 12 running meters
err	line break
no display	no power present

Scope of delivery

1 piece	Monitoring device RLA ^{net}
1 piece	Data sheet/quick guide

Type label

Exemplary depiction of type plate:

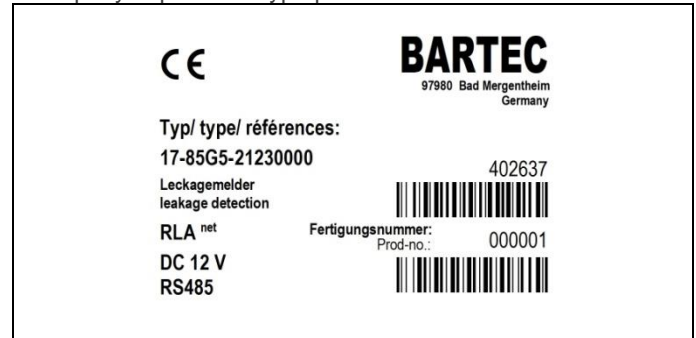

4.2. Software description

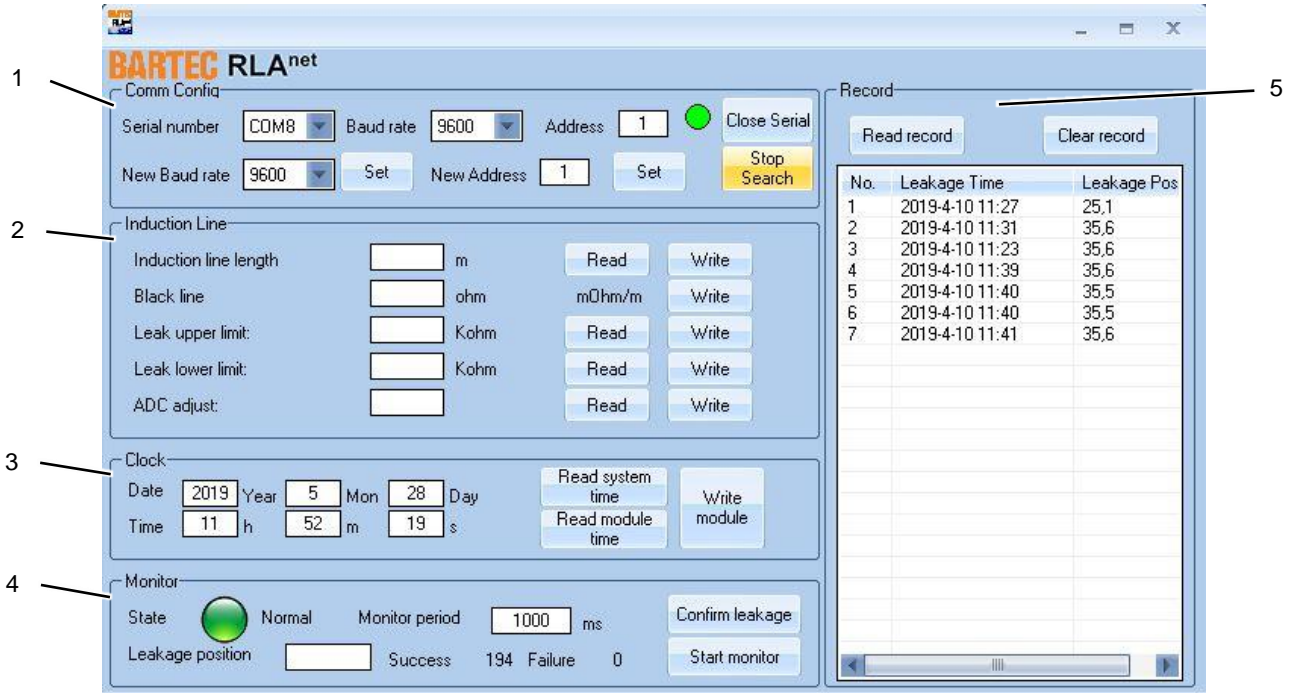

Key

Item	Description	Function
1	Interface settings (Comm Config)	Communication settings for the RLA ^{net}
2	Sensor parameter settings (induction line)	Settings of the connected sensors
3	Date/time settings (clock)	Date and time settings
4	Leak monitoring area (monitor)	Display and control of leakage monitoring
5	Event storage area (record)	Display and control of leakage events

5. Functional description

After switch-on, the RLA^{net} carries out a self-test. All values on the display as well as all LEDs are shown for a period of 1 second. The alarm relay is energised until the self-test is completed. The RLA^{net} then switches to operating mode and the alarm relay drops out. The leakage monitoring of the system is now active. Visibly on: red "power" LED.

There are 3 LEDs on the front of the RLA^{net} indicating operational and sensor status (leakage detected and open circuit) and 2 LEDs on the board for Modbus RTU communication (RX=incoming and TX=outgoing).

After detecting a leak, the RLA^{net} generates a message that specifies the location to the meter, and the alarm relay picks up. The relay contacts can be used for a local or "remote" alarm, control valve or other devices.

During the leak notification, the beeper can be switched off with the "confirm" button. The leak message itself remains on the display. The alarm relay remains energised.

The beeper can also be switched off in the service programme by pressing the "confirm leak" soft button.

In this case, the RLA^{net} is also reset for 0.5 seconds, the alarm relay drops out, the LEDs and the display go to "normal" (no leak).

If the leakage is still present, the message appears as described.

If the sensor cable breaks, the RLA^{net} generates a corresponding message on the display. The alarm relay remains de-energised.

6. System planning

The installation must be carried out carefully in compliance with all legal requirements and in compliance with the technical data of all components used.

For system planning, please also note Chapter 16.3 "Example system planning" and 16.6 "Information on project planning, wiring diagrams".

Please note for point sensors PSO and PSO+:

- Consider the voltage drop in the supply line
- Comply with the current limit of the voltage source

6.1. Modbus RTU communication

The RLA^{net} has a digital interface for forwarding the leakage system states, for example to a building control centre. Up to 250 pieces of RLA^{net} can be addressed in a Modbus RTU network via this interface. For connection to the building control centre, please see the wiring diagram in Chapter 3.1.

Only the service software is suitable for parameterising the leakage system. Direct access to system parameters via the Modbus RTU protocol is not possible.

The Modbus communication parameters are described in the supplementary documentation "RLAnet Modbus Communication Protocol". This is available at www.bartec.com. Keyword search for "RLA".

7. Assembly

The assembly must be carried out carefully and in accordance with system planning, the applicable national standards, regulations and approvals, the technical data of the individual components and these assembly and operating instructions.

7.1. Mechanical assembly

The RLA^{net} can be easily attached to a TS35 top-hat rail using a top-hat rail clip.

The RLA^{net} may only be installed and operated within an approved electrical control cabinet. Please ensure adequate ventilation during operation, if necessary provide air supply and exhaust ducts in the control cabinet. The RLA^{net} must not be exposed to direct sunlight or moisture.

BARTEC recommends checking the electrodes of the PS sensors and the optics of the PSO sensors to ensure they are clean and free of grease. Clean the electrodes and the optics with alcohol or a degreasing household cleaner.

The plug-in connections of the sensors and the sensor cable required for the installation must be routed so that they are protected against moisture. When monitoring surfaces, spacers available as accessories must be inserted between the plug connection and the floor.

7.2. Electrical assembly

	<p>CAUTION! Risk of injury from electric shock</p> <p>Disconnect the device from the power supply before installation!</p> <p>Observe the five safety rules!</p> <p>Observe the technical data of the device and the wiring diagram!</p>
--	---

The RLA^{net} monitoring device must be connected according to the wiring diagram (see technical data). Before connection, the ends of multi-core or fine-stranded conductors must be stripped and fitted with ferrules.

The protective earth conductor must be connected to the grounding system of the power supply. Tests must be performed to ensure continuity of grounding.

The strain relief of all cables must be ensured

7.3. Laying of the sensor cable

Example of laying under raised floors:

The sensor line must lie on the surface to be monitored. If necessary, fix the sensor cable with suitable adhesive tape. The surface to be glued onto must be dry, clean and largely free of dust. Fasten the sensor cable at 1m intervals with BARTEC fastening tape.

Do not fix the sensor cable directly to metal parts. This can falsify the measurement results of the RLA^{net}. Use non-detecting connection lines, protective hoses or flexible hoses for wall ducts or limiting constructions (line routes, etc.). The sensor cable can be routed around boundary structures (cable routes). Ensure that the sensor cable is adequately fastened and that the sensor cable lies on the surface to be monitored.

Distillate from pipes and cooling units must not wet the sensor line.

Structural damages to the sensor cable should be avoided as far as possible. If structural avoidance is not possible, the label "sensitive sensor cable" can be used. See Chapter 14 "System accessories".

7.4. Connecting the point sensors

The conductive PS point sensors and the optical PSO+ point sensors can be integrated into the wiring of the SCR sensor cable.

The information in the operating instructions for the point sensors on installation, commissioning, operation and maintenance must be observed.

8. Commissioning

In the application documents, the running meters of the SCR sensor cable and/or the PS point sensor, or PSO, which are monitored by the RLA^{net}, should be given, e.g. shown on a blueprint or on a general site map.

The countermeasures that are initiated when a leak is reported must be adapted to the damage to be avoided in terms of scope and reaction speed. The owner/management company must find out about the requirements from the respective insurance company (building insurance, liability insurance), e.g. test intervals, scope of testing and training of operating personnel.

The commissioning report in Chapter 16.2 must be filled out during commissioning and attached to the system documentation.

Check sensor cable and point sensors

According to the test report - see Chapter 16.1

Warranty claims can only be asserted by submitting a correctly and completely filled out acceptance report. The form must also be dated and signed.

9. The service programme

The "RLA_net_com" programme is the software communication interface of the RLA^{net} monitoring device and is displayed on a PC. In this programme the user can set the basic parameters of the RLA^{net} and the application parameters of the connected sensors and upload them to the RLA^{net}.

Changes to the set values can be made with the service programme.

Factory preset values of the RLA^{net} are suitable for the first start-up of the monitoring function of the leakage detection system. For the correct localisation of the leakage, the application data must be adapted to the local situation and the installed system.

Factory preset values for process representation and parameterisation: The data is available in the MODBUS RTU protocol. A detailed description can be found in Chapter 9.3 Setting the sensor parameters.



ATTENTION!

Warning regarding the incorrect setting of RLA^{net} parameters

If the RLA_net_com programme is run in online mode, important parameters of the connected RLA^{net} may change. This can affect the operational reliability of the entire water detection system. Only trained technical personnel are allowed to run the RLA_net_com program in online mode.

The "RLA_net_com" programme can be run in WINDOWS 7 / 8 / 10 operating systems.

It can be copied to any directory on the PC, where the serial USB interface of the PC can be used (see also the additional information and logs in Chapter 16 "Annexes").

9.1. Starting the service programme

The RLA_net_com programme is started by double-clicking on the EXE file. The installation will then begin.



Link to the programme on the desktop:

If prompted, click on the desired language to select it:

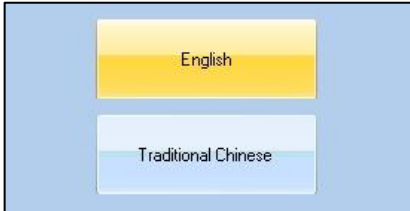

The start screen is then displayed:

No.	Leakage Time	Leakage Pos
1	2019-4-10 11:27	25,1
2	2019-4-10 11:31	35,6
3	2019-4-10 11:23	35,6
4	2019-4-10 11:39	35,6
5	2019-4-10 11:40	35,5
6	2019-4-10 11:40	35,5
7	2019-4-10 11:41	35,6

Set basic parameters (factory settings)

Serial number: COM1

Baud rate: 9600

MODBUS RTU address: 0

9.2. Setting the interface, creating a connection to RLA^{net}

Software area Comm Config



Figure 1 Comm Config programme area, communication interrupted

Communication settings between the software and RLA^{net} can be set in the Com Config section.

Values can be entered in the upper line relating to the interface (serial number), the speed (baud rate) and the position or the connected monitoring devices RLA^{net} with which the entire system is to be addressed (address).

In the lower line, the speed and position values with which the selected RLA^{net} was previously addressed can be changed. The existing drop-down list must be used for this. Save the new values with the Set button. The communication between the software and the connected RLA^{net} of the entire system can be started or ended with the Open Serial/Close Serial button. The red or green display shows the current communication status. The assigned address of the connected RLA^{net} can be displayed with the Search address button.



ATTENTION!

Warning regarding the incorrect setting of RLA^{net} parameters

When changing the address in an existing network with several connected RLA^{net} devices, it is recommended to consult the associated documentation of the water detection system. Create or modify a mapping table containing the RLANet device name, Modbus address, location, warning labels, sensor parameters, etc. Please note the annexes of these assembly and operating instructions.



Figure 2 Comm Config programme area, communication active

If the "Serial number" of the COM port is incorrect, the following error message appears:

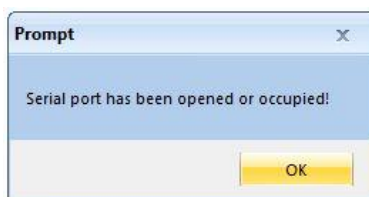

In this case, the setting of the COM port must be checked. Please also note Chapter 16.4 "PC settings" and 16.5 "USB computer interface".

9.3. Setting the sensor parameters

Software area Induction Line



ATTENTION!

Warning regarding the incorrect setting of RLANet parameters

Set parameters must match the installed components of the system.

Please note the sensor length and number of sensors.

For an accurate locating function, it is important to set the Induction Line Length and Black Line parameters to match the data from the sensor connected to the RLA^{net}.

The application parameters of the connected sensor (connection/length) are:

Induction line length: ___ m

Black line: ___ ohms

Example 1:

A 30 m long SCR sensor cable is connected.

(Rating of SCR: 6.0 ohms/m)

Induction line length: 30 m; click the "Write" button.

Black line: 180ohms (30m * 6.0ohms/m = 180ohms); click the "Write" button.

The following nominal value is displayed as a result of the RLA^{net}'s internal calculation: 6000 mohms/m

Induction Line			
Induction line length	<input type="text" value="30"/>	m	<input type="button" value="Read"/> <input type="button" value="Write"/>
Black line	<input type="text" value="180"/>	Ω	6000 mΩ/m <input type="button" value="Write"/>

Example 2:

Connection of a 30 m long SCR sensor cable and 2 point sensors PS in series

(Rating of SCR: 6.0 ohm/m)

(rated value of the PS: 60 ohms, corresponds to 10 m)

Induction line length: 50m (30m + 2*10m); click the "Write" button.

Black line: 300 ohms (30m*6.0 ohm/m + 2*60 ohms = 300 ohms); click the "Write" button.

The following nominal value is displayed as a result of the RLA^{net}'s internal calculation: 6000 mohm/m

The following parameters remain in the factory setting.

Leak upper limit:	<input type="text" value="120"/>	Kohm	<input type="button" value="Read"/> <input type="button" value="Write"/>
Leak lower limit:	<input type="text" value="1"/>	Kohm	<input type="button" value="Read"/> <input type="button" value="Write"/>
ADC adjust:	<input type="text" value="1000"/>		<input type="button" value="Read"/> <input type="button" value="Write"/>

9.4. Setting the date and time

Software area Clock

The RLA^{net} records the date and time.

For a correct recording in the event log it is recommended to set the clock of the RLA^{net} to the actual time.

To do this, use the fields and buttons shown below.

Description of the software area 'Clock':

"Read system time" reads the computer's date and time.

"Write module" then writes the date and time of the computer to the RLA^{net}.

The screenshot shows a software interface titled 'Clock'. It contains two rows of input fields for date and time. The date row has fields for Year (2016), Mon (6), and Day (14). The time row has fields for h (10), m (34), and s (40). To the right of these fields are three buttons: 'Read system time', 'Read module time', and 'Write module'.

9.5. Controlling leakage monitoring

Software area Monitor

The programme can be operated with a PC mouse. It basically acts as a remote console for the actual RLA^{net} device.

i **ATTENTION!**

Warning regarding the incorrect setting of RLA^{net} parameters

The set parameters must match the installed components of the system.

Please note the sensor length and number of sensors.

The application parameters may only be changed on instruction of the operating company. It is also a good idea to consult the project planning documents.

Description of the software area 'Monitor':

State describes the current operating status (normal, leak, service/break).

The desired monitoring cycle time in which a test pulse is sent is entered after **Monitor period**. Default: 1000ms

Leakage position indicates the distance at which a leak was detected (accuracy 1 m).

Success is a counter that counts the test pulses sent and reported back without errors per set time. It starts automatically upon starting the monitoring of the system by pressing the Start monitor button. The count is reset when the Stop monitor button is pressed.

Failure is a counter that counts the test pulses sent and reported back with errors per set time. Failure means that there is an error in the wiring or Modbus communication. It does not mean that there is an error in the SCR sensor line.

With the **Start/Stop Monitor** button, the real-time visualisation of the leakage monitoring of the system is started or stopped. At the same time, a counter is started that reports back the error-free or faulty test pulse (counter success, counter failure).

With the **Confirm leakage** button, the leakage warning is confirmed and the warning signal is ended.



ATTENTION!

Warning of unresolved leakage

The RLA^{net} is reset by pressing the Confirm leakage button. The error message in the display is deleted.

It is necessary to check the system for existing leaks! If necessary, arrange for the cause of the leak to be eliminated.

The Confirm leakage button should only be used by the service personnel responsible for troubleshooting and repairs.

Monitor

State  Normal Monitor period ms

Leakage position Success 7 Failure 0

Monitor

State  Normal Monitor period ms

Leakage position Success 7 Failure 0

9.6. Viewing the event log

Software area Record

The RLA^{net} stores up to 32 events in its memory. All other events are not saved.

These stored events can be called up using the "Read record" button.

The memory can be cleared by clicking on the "Clear record" button.



PLEASE NOTE!

Risk of data loss

Do not delete information about leaks and system malfunctions in general. This information can provide important information to service technicians.

The report can only be displayed when the service programme's monitoring mode is ended, i.e. the "Stop Monitor" button in the Monitor software area has been pressed.

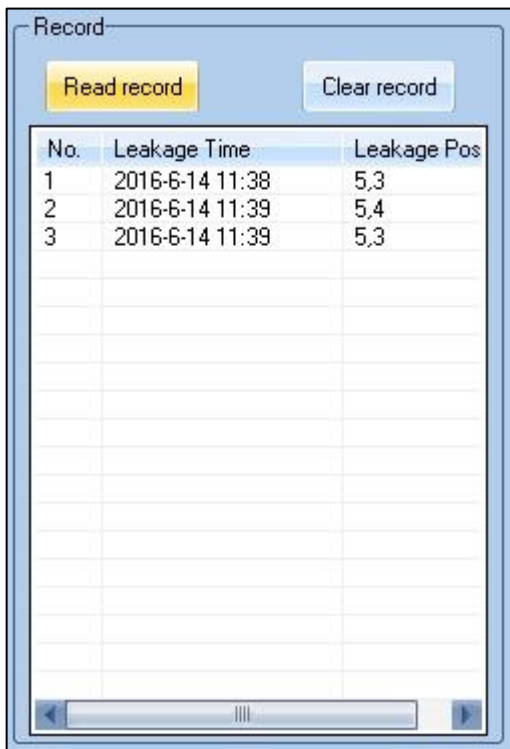
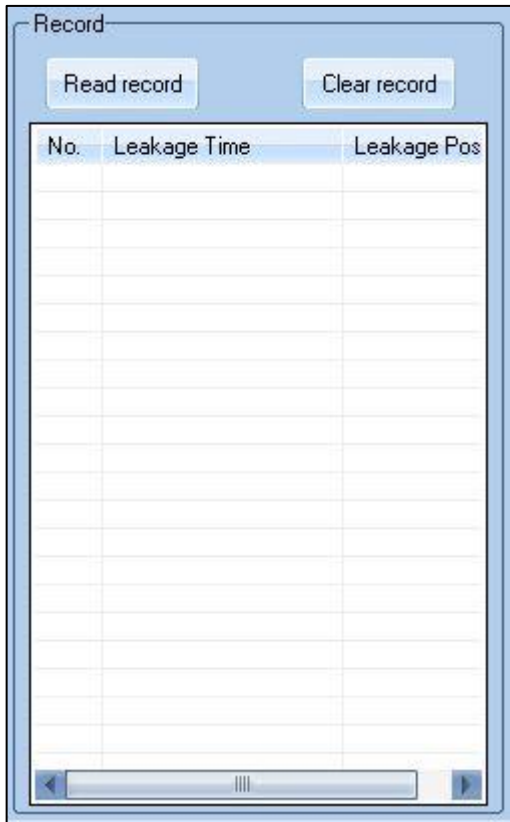

10. Operating states

10.1. Operating state Normal

Click the "Start monitor" button to start the monitor mode.

Monitor

State  Normal Monitor period ms

Leakage position Success 7 Failure 0

The Normal state indicates that no leak has been detected along the sensors and that there are no faults in the sensor wiring.

The value of the "Success" counter increases.

Click the Stop monitor button to exit the monitor mode.

Monitor

State  Normal Monitor period ms

Leakage position Success 7 Failure 0

10.2. Operating state Leak

Click the "Start monitor" button to start the monitor mode.

Monitor

State  Leak Monitor period ms

Leakage position Success 109 Failure 0

The "Leak" state indicates that a leak has been detected along the sensors.

The leak is displayed in the "Leakage position" field with an accuracy of 1 meter.

Click the Stop monitor button to exit the monitor mode.

Monitor

State  Leak Monitor period ms

Leakage position Success 109 Failure 0

10.3. Operating state Service/Break

Click the "Start monitor" button to start the monitor mode.

Monitor

State  Break Monitor period ms

Leakage position Success 48 Failure 0

The "Break" state indicates that there is a problem with the sensors or the sensor wiring.

Click the Stop monitor button to exit the monitor mode.

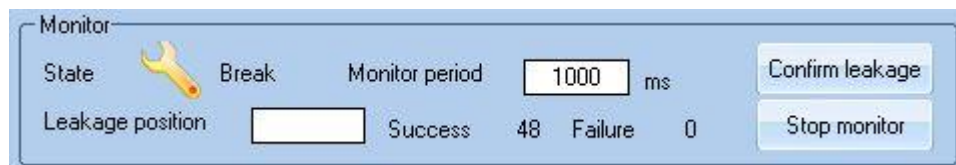

11. Operation

The installed system can be monitored for leaks while the RLA^{net} is in operation. A prerequisite is that the system has been professionally installed and commissioned. The RLA^{net} shows the current operating status of the system on the device and the software.

The product service life of the RLA^{net} is designed to last for more than 10 years.

The product is suitable for permanent use and is maintenance-free.

In the event of a fault or leakage, first check the function of the downstream equipment.

The table below shows some fault events, their cause or effect and the measures to be taken.

Fault	Cause	Effect/ measures
Leak, but location is dry	Multiple leaks present at the same time	The nearest leak is displayed / read out the error memory, check all localisation points
Leak comes and goes	Condensing humidity	Dew point reached under insulation / read out fault memory, dry and seal insulation
Service message comes and goes	Faulty contacting in the wiring	Line break / read error memory, check all clamp and plug connections

12. Maintenance

	<p>CAUTION! Risk of injury from electric shock</p> <p>Disconnect the device from the power supply before installation!</p> <p>Observe the five safety rules!</p>
--	---

The RLA^{net} product is suitable for permanent use and is maintenance-free.

However, BARTEC recommends subjecting the entire leakage system to an inspection at least once a year.

The SCR sensor cable and the PS/PSO point sensor are largely maintenance-free. BARTEC recommends checking the electrodes of the PS sensors and the optics of the PSO sensors to ensure they are clean and free of grease. Clean the electrodes and the optics with alcohol or a degreasing household cleaner.

If changes have to be made to the installed system, the notes on installation in Chapter 7 and the information on Modbus RTU communication in Chapter 6 may have to be observed.

Note: If necessary, comply with the inspection intervals of the respective insurance company (building insurance, public liability insurance).

13. Decommissioning, dismantling

	<p>CAUTION! Risk of injury from electric shock</p> <p>Disconnect the device from the power supply before installation!</p> <p>Observe the five safety rules!</p>
--	---

- Detach the connection cable from the terminals and separate it from the connection socket
- Detach the device from the bracket and remove it.

Dismantle the leakage monitoring system in accordance with the applicable local occupational health and safety and environmental regulations. Sort the components according to the materials. Recycle the components:

- Scrap metals
- Recycle plastic elements
- Other components according to material properties

Electrical scrap and electronic components are subject to hazardous waste treatment. The local municipal authority or special disposal companies will provide information on an environmentally friendly disposal.



14. System accessories

Description	Order no.
SCR sensor cable, sold by the meter	17-85M1-1761
Connecting cable, sold by the meter	02-4042-0011
Point sensor PS	17-85M1-38320A00
Point sensor optical PSO	17-85M6-11020A00
Point sensor optical PSO+	17-85M6-11021A00
Plug assembly kit for SCR sensor cable	05-0091-0054
Coupling assembly kit for SCR sensor line	05-0091-0055
Line termination for SCR sensor line	05-0080-0161
Area separation module for SCR sensor cable	05-0080-0162
T-branch distributor for SCR sensor cable and PS point sensor	17-85Z4-3200
Fastening strap for SCR sensor cable and PS point sensor	05-0091-0045
Adapter RS485 to USB port (USB-RS485 bridge), also available ready-made	03-9829-0108

	<p>Sensitive Sensor Cable - Warning Label</p> <p>Warning label for water warning systems</p> <p><i>Recommended for the marking of sensitive sensor cables indoor and outdoor use</i></p> <p><i>self-adhesive polyester label, yellow</i></p> <p><i>temperature range -40 °C to 80 °C</i></p> <p><i>Size 100x50 mm</i></p>	<p>Part No.: 05-2144-0777</p>
---	--	-------------------------------

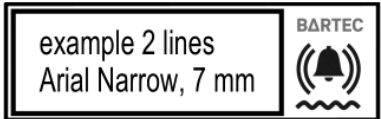
	<p>Water Warning System – Acryl Information Label</p> <p>Information label for water warning systems</p> <p><i>Self-adhesive acrylic label, laser engraved, white, 1 mm thick</i></p> <p><i>two lines with customer specific labeling</i></p> <p><i>indoor use</i></p> <p><i>temperature range -20 °C to 85 °C</i></p> <p><i>Size 80x25 mm</i></p>	<p>Part No.: 05-2144-1560</p>
---	---	-------------------------------

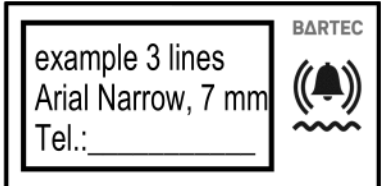
	<p>Water Warning System – Foil Information Label</p> <p>Information label for water warning systems</p> <p><i>Self-adhesive polyester foil, thermal transfer printing, white</i></p> <p><i>one, two or three lines with customer specific labeling</i></p> <p><i>indoor use</i></p> <p><i>temperature range -40 °C to 150 °C</i></p> <p><i>Size 74x37 mm</i></p>	<p>Part No.: 05-2144-1561</p>
---	---	-------------------------------

15. EU Declaration of Conformity

EU Konformitätserklärung EU Declaration of Conformity Déclaration UE de conformité		 BARTEC GmbH Max-Eyth-Straße 16 97980 Bad Mergentheim Germany	
N° 11-85G5-7C0001			
Wir	We	Nous	
BARTEC GmbH,			
erklären in alleiniger Verantwortung, dass das Produkt	declare under our sole responsibility that the product	attestons sous notre seule responsabilité que le produit	
Überwachungs- elektronik RLA^{net}	Electronic monitoring unit RLA^{net}	Electronique de supervision RLA^{net}	
17-85G5-2123/****			
auf das sich diese Erklärung bezieht den Anforderungen der folgenden Richtlinien (RL) entspricht	to which this declaration relates is in accordance with the provision of the following directives (D)	se référant à cette attestation correspond aux dispositions des directives (D) suivantes	
EMV-Richtlinie 2014/30/EU	EMC-Directive 2014/30/EU	CEM-Directive 2014/30/UE	
RoHS-Richtlinie 2011/65/EU	RoHS-Directive 2011/65/EU	RoHS-Directive 2011/65/UE	
und mit folgenden Normen oder normativen Dokumenten übereinstimmt	and is in conformity with the following standards or other normative documents	et est conforme aux normes ou documents normatifs ci-dessous	
EN 62321:2009	EN 61326-1 :2013 EN 61000-3-2:2014 EN 61000-3-3:2013		
Verfahren der internen Fertigungskontrolle	Procedure of internal control of production	Procédure de contrôle interne de fabrication	
CE			
Bad Mergentheim, den 01.09.2016			
 i.V. Tobias Dold Leiter Produktmanagement EHT		 i.V. Michael Schulte Leiter GW PZ	
03-0383-0366		Seite / page / page 1 von / of / de 1	

16. Annexes

16.1. Test reports (SCR, PS/PSO)

Prüfprotokoll Sensorkabel SCR Typ 17-85M1-1761

Kunde: _____

Komm.-Nr.: _____

Projekt: _____

Gebäude: _____

BARTEC GmbH
 Max-Eyth-Straße 16
 97980 Bad Mergentheim
 Tel: +49 (0)7931 597 0

Pos.:	Verlegte Kabellänge in Meter	gemessener Isolationswiderstand in M Ω zwischen den Leitern 1 und 3 vor dem Einbau	gemessener Isolationswiderstand in M Ω zwischen den Leitern 1 und 3 nach dem Einbau *	gemessener Isolationswiderstand in M Ω zwischen Leiter 1 gegen Erde Leiter 3 gegen Erde *	Durchgangswiderstand in Ω zwischen Leiter 1 und 2 Leiter 3 und 4 *	errechneter Durchgangswiderstand in Ω /m **	Zone	Stockwerk / Raumnummer	Meleranzzeige AufRLA ^{net}	Prüfdatum / Prüfer

Hinweis:
 Das Sensorkabel muss auch während der Montage kontrolliert werden.
 Sind PSO und PSO+ im Messkreis mit angeschlossen, dann Widerstandsmessung nur bei eingeschalteter Versorgungsspannung!
 Bei diesen Prüfungen muss die Sensork von der Überwachungselektronik getrennt werden.

Prüftoleranzen für die Messungen
 Durchgangswiderstand in Ω : min.: 5,7 Ω /m max.: 6,3 Ω /m

Isolationswiderstand in M Ω : nicht kleiner als 10 M Ω pro gesamten Messkreis (bei 500V Prüfspannung)
 * gemessen mit Enddrücken bei RLA^{net} bzw. Endwiderstand bei RDA / RDW
 ** gemessener Widerstand von Leiter 1 und 3 in Ω / verlegte Kabellänge (PSO = 10 Meter) = errechneter Widerstand in Ω / m

Stempel/Unterschrift der Montagefirma _____

SCR Aufbau:
 Leiter 1 = Ader weiß, perforiert
 Leiter 2 = Ader weiß, isoliert
 Leiter 3 = Ader rot, perforiert
 Leiter 4 = Ader rot, isoliert

Gewährleistungsansprüche können nur durch Vorlage eines korrekt und vollständig ausgefüllten Abnahmeprotokolls geltend gemacht werden. Das Formular muss außerdem datiert und unterschrieben sein.

Prüfprotokoll Punktsensor

BARTEC GmbH

Max-Eyth-Strasse 16
97980 Bad Mergentheim
Tel: +49 (0)7931 597 0

Kunde: _____ Komm.-Nr.: _____

Projekt: _____ Gebäude: _____

Anzahl pro Strang	Sensor-Typ z.B. PS PSO PSO+	gemessener Isolationswiderstand in MΩ zwischen Leitern 1 und 3 vor dem Einbau	gemessener Isolationswiderstand in MΩ zwischen Leitern 1 und 3 nach dem Einbau *	gemessener Isolationswiderstand in MΩ zwischen Leiter 1 gegen Erde Leiter 3 gegen Erde	Durchgangswiderstand in Ω zwischen Leiter 1 und 2 Leiter 3 und 4	errechneter Durchgangswiderstand in Ω/m **	Zone	Stockwerk / Raumnummer	Meteranzeige Auf RLA ^{net}	Prüfdatum / Prüfer

Hinweis:

Widerstandsmessung bei PSO und PSO+ nur bei eingeschalteter Versorgungsspannung!
Bei diesen Prüfungen muss die Sensorik von der Überwachungselektronik getrennt werden.

Prüftoleranzen für die Messungen
Durchgangswiderstand in Ω: min.: 5,7 Ω/m max.: 6,3 Ω/m

Isolationswiderstand in MΩ: nicht kleiner als 10 MΩ pro gesamten Messkreis (bei 500V Prüfspannung)

* gemessen mit Endbrücke bei RLA^{net} bzw. Endwiderstand bei RDA / RDW

** gemessener Widerstand von Leiter 1 und 3 in Ω / verlegte Kabellänge (lPSO = 10 Meter) = errechneter Widerstand in Ω / m

Stempel/Unterschrift der Montagefirma

Gewährleistungsansprüche können nur durch Vorlage eines korrekt und vollständig ausgefüllten Abnahmeprotokolls geltend gemacht werden. Das Formular muss außerdem datiert und unterschrieben sein.

16.2. Start-up report

Inbetriebnahmeprotokoll Wasserwarnsystem	
Kunde/Endkunde	
Auftragsnummer	
Datum	
Überwachungsgerät Typ, Fert.Nr.	
Softwareversion	
Zuleitung Typ, Länge	
angeschlossener Sensor 1 Typ, Länge, Raum	
angeschlossener Sensor 2 Typ, Länge, Raum	
Sonstiges	
Funktionstest	
Alarm-/Leckagetest	
Bruchtest	
Potentialfreie Alarmkontakte	
Potentialfreie Fehlerkontakte	
Summer intern	
Bemerkungen	
Ergebnis	
Nach Durchführung der Prüfungen/Messungen war das System ohne/mit Mängel und Einschränkungen funktionsfähig (s. Bemerkungen).	
Oben stehende Angaben geprüft:	
Ort, Datum	Firma/Unterschrift Prüfer
	Firma/Unterschrift Kunde
Für Gewährleistungsansprüche ist die Vorlage eines korrekt und vollständig erstellten Abnahmeprotokolls zwingend erforderlich. Datum und Unterschrift dürfen nicht fehlen.	
Serviceadresse	
BARTEC GmbH Max-Eyth-Str. 16 97980 Bad Mergentheim Tel.: +49 7931 597 0 info@bartec.com www.bartec.com	
Vorbehalt Technische Änderungen behalten wir uns vor. Änderungen, Irrtümer und Druckfehler begründen keinen Anspruch auf Schadensersatz.	
www.bartec.com	BARTEC

16.3. Example system planning

Example of a project planning document and specifically in a "water detection system documentation":

Create or modify a mapping table containing the RLA^{net} device name, Modbus address, location, warning labels, sensor parameters, etc.

Name of RLA ^{net} -device	Modbus address	Site	Warning label	Sensor parameters: "Induction line length"	Sensor parameters: "Black line"	Response to leakage error	Leakage notification of the RLA ^{net} device
=A-10N1	001	Building #1 Room 101	Leak server room 101	30 m	180 m	Turn off the chiller; alarm message for service personnel	between 0 and 30 m
=A-11N1	002	Building #1 Room 102	Leak server room 102	20 m	120 m	Turn off the chiller; alarm message for service personnel	between 0 and 20 m
=A-12N1	003	Building #1 Room 110	Leak room 110, next to door	Point sensor 1		Switch off the fresh water pipe valve	approx. 0 m
			Leak room 110, window wall	Point sensor 2		Switch off the fresh water pipe valve	approx. 10 m
			Leak room 120, sink	Point sensor 3		Alarm message for service personnel	approx. 20 m
			Leak room 120, emergency shower	Point sensor 4		Alarm message for service personnel	approx. 30 m



ATTENTION!

Warning regarding the incorrect setting of RLA^{net} parameters

Changing the address of RLA^{net} devices in an existing network is not permitted.

When changing the address in an existing network with several connected RLA^{net} devices, it is recommended to consult the associated documentation of the water detection system. Create or modify a mapping table containing the RLA^{net} device name, Modbus address, location, warning labels, sensor parameters, etc. Observe the appendix of these assembly and operating instructions.



ATTENTION!

Warning regarding the incorrect setting of RLA^{net} parameters

Set parameters must match the installed components of the system.

Please note the sensor length and number of sensors.

16.4. PC settings

If the USB adapter's "plug and play" does not work, it is recommended to update the drivers.

To do this, in the [Device Manager] of the WINDOWS operating system under [Ports (COM & LPT)], the device "USB Serial Port" must be called up by right-clicking on [Update driver].

The COM interface for the "USB Serial Port" is assigned automatically by the operating system. This can be read.

Example: COM8 assigned

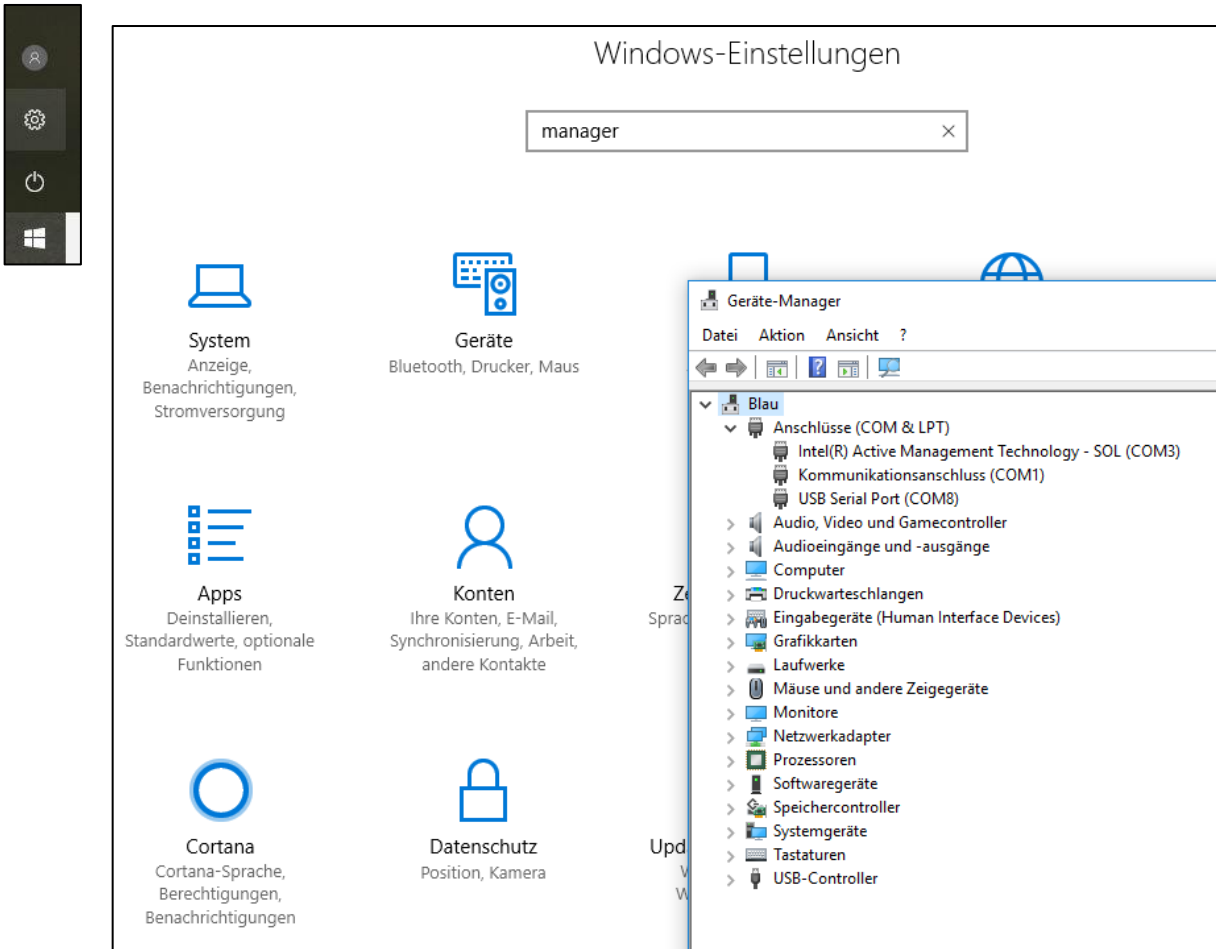

16.5. USB computer interface

When using several RLA^{net} devices in the RS485 data communication network, the interface to a PC (also to its USB port) can be implemented with an RS485 to USB adapter. When running the service software, the node number can be retrieved or changed. A length of up to 500 m is possible for the twisted pair line of the RS485 bus. The RS485 bus can also be used for stand-alone use of the RLA^{net} in order to bridge a greater distance for communication with a PC.

An RS485 to USB adapter enables connection to a PC via USB port. The COM interface is assigned automatically by the operating system (see below).



The product USB-RS485-Bridge from the manufacturer IN-CIRCUIT (available via RS Components) has been tested and works perfectly. The driver update takes place via the Internet during installation (<http://www.in-circuit.de>).

To set the DIP switches, please see below:

DIP 1...4: OFF

DIP switch no.	Function ('ON' = active)
1	Local echo (data sent will be received, too)
2	R = 390 Ω between signal A and VCC
3	R = 220Ω between signal A and B
4	R = 390Ω between signal B and GND

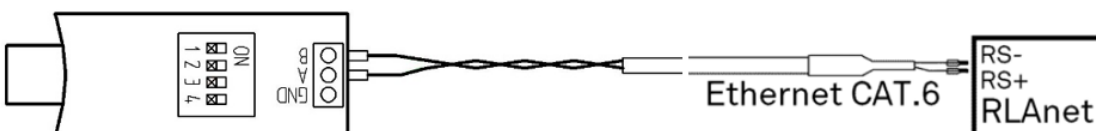
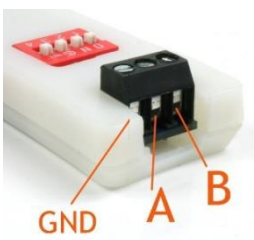

Wiring example patch line CAT.6

RJ45 pin 4	B (MOD_D1) --- BU	RLA ^{net} RS-
RJ45 pin 5	A (MOD_D0) --- WH/BU	RLA ^{net} RS+

16.6. Information on project planning, wiring diagrams

When supplying power to point sensors PSO and PSO+, it must be ensured that the voltage drop across the supply line does not become too great and that the current limit of the voltage source is not exceeded.

PSO and PSO+ ratings: $U_{min} \text{ PSO} = 16.8\text{V}$; $I_{n \text{ PSO}} = 20\text{mA}$

a) Voltage drop on the supply line

$$R = \frac{\rho \cdot l}{A} \quad U_v = U_n - U_{min \text{ PSO}} \quad n \text{ PSO} = \frac{U_v}{\frac{U_v}{R} \cdot I_{n \text{ PSO}}}$$

Example 200 m total length; 0.5 mm^2 ; $\rho \text{ copper} = 0.018 \frac{\Omega \text{mm}^2}{\text{m}}$; $U_n = 24 \text{ Vdc}$

$$R = \frac{0.018 \cdot 200}{0.5} \Omega = 7.2 \Omega \quad U_v = 24 \text{ V} - 16.8 \text{ V} = 7.2 \text{ V} \quad n \text{ PSO} = \frac{7.2 \text{ V}}{0.02 \text{ A}} = 50 \text{ pieces}$$

Example 350 m total length; 0.5 mm^2

$$R = \frac{0.018 \cdot 350}{0.5} \Omega = 12.6 \Omega \quad U_v = 24 \text{ V} - 16.8 \text{ V} = 7.2 \text{ V} \quad n \text{ PSO} = \frac{7.2 \text{ V}}{0.02 \text{ A}} = 28 \text{ pieces}$$

b) The current limit of the voltage source



ATTENTION!

Warning of system damage due to an overloading of the power pack

Observe the maximum rated current when connecting PSO and PSO+ sensors. If necessary, use a separate power pack.

With BARTEC wall-mounted devices, a power pack is used, which serves to power the built-in devices. If additional point sensors PSO and PSO+ are to be connected directly to this power pack, the maximum nominal current must be taken into account. A separate power supply must be used.

The potential separation between the measuring circuit and the power supply, as well as to the alarm contact in the point sensors PSO and PSO+ enables the use of decentralised power supplies.

Configuration of the power supply unit:

Rated current RLA^{net} : $I_r = 0.25 \text{ A}$

Rated current PSO+/PSO: $I_p = 20 \text{ mA}$

Rated current power relay coil (example): $I_s = 90 \text{ mA}$

Universal power pack installed in the wall housing (example): $I_n = 0.63 \text{ A}$

$$n \text{ PSO} = \frac{I_n - I_r - I_s}{I_p}$$

Example universal power supply; 1 RLA^{net} :

$$n \text{ PSO} = \frac{0.63 \text{ A} - 0.25 \text{ A}}{0.02 \text{ A}} = 19 \text{ pieces}$$

Example universal power supply; 1 RLA^{net} ; 1 power relay:

$$n \text{ PSO} = \frac{0.63 \text{ A} - 0.25 \text{ A} - 0.09 \text{ A}}{0.02 \text{ A}} = 15 \text{ pieces}$$

Example separate universal power supply: $I_n = 1.2 \text{ A}$

$$n \text{ PSO} = \frac{1.2 \text{ A}}{0.02 \text{ A}} = 60 \text{ pieces; max. 50 pieces per } RLA^{net}$$

Factory-made devices " RLA^{net} in wall housing" are pre-wired according to the following wiring diagrams. The connection plan is glued into the housing as a label.

Type 17-85G5-21230901 IP housing; 1 universal power supply; 1 RLA^{net}

Guaranteed number of PSO/PSO+ that can be supplied by the power pack (0.63 A): 19 pieces

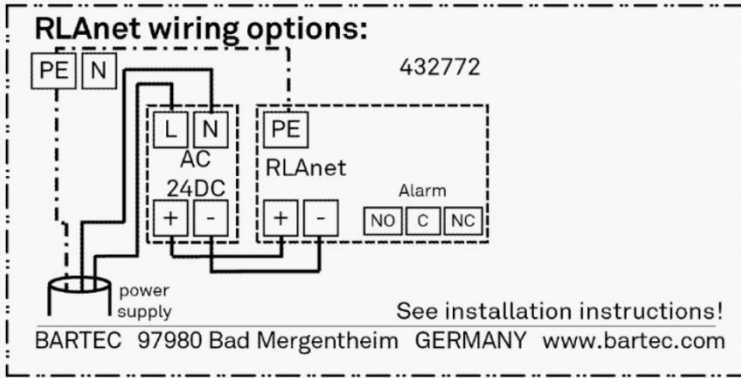

Type 17-85G5-21230100 IP housing; 1 universal power supply; 1 RLANet; 1 power relay

Guaranteed number of PSO/PSO+ that can be supplied by the power pack (0.63 A): 15 pieces

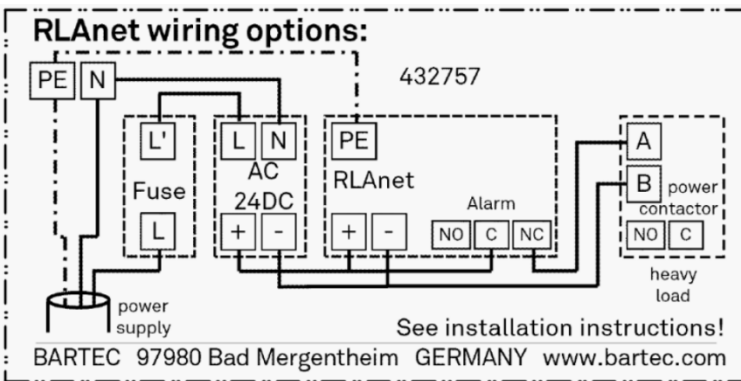

Type 17-85G5-21230902 IP housing; 1 universal power supply; 2 RLANet

Guaranteed number of PSO/PSO+ that can be supplied by the power pack (0.63 A): 6 pieces

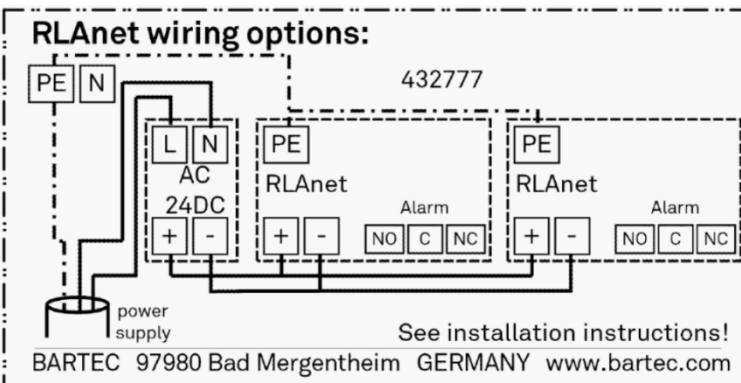

(other types on request)

BARTEC GmbH
Max-Eyth-Str. 16
97980 Bad Mergentheim
Germany

Phone: +49 7931 597 0

info@bartec.com

bartec.com